

Colombini'Casa



VOLO LIVING & NIGHT & KIDS & CONTRACT

ELEMLISTA - Modern Nappali Bútorokhoz & Hálószoba Bútorokhoz & Gyerekbútorokhoz



BONO DESIGN Kft.

1036 Budapest, Bécsi út 81.

06-1/240-02-42

06-30/22-32-120

info@bonodesign.hu

www.bonodesign.hu

Legenda corrispondenza colori

Colour correspondence key

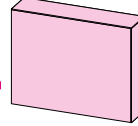

Finiture GRUPPO 1
GROUP 1 finishes



Facciate Fronts
VOLO

Finiture GRUPPO 2
GROUP 2 finishes

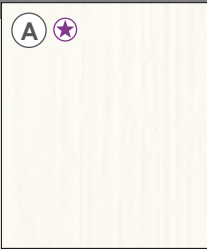
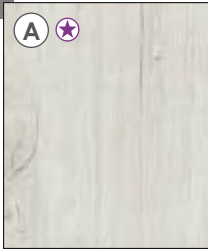
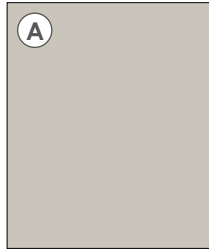

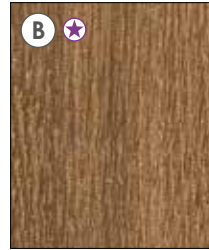
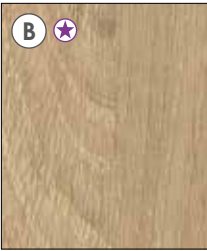
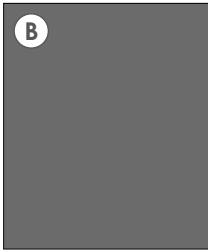
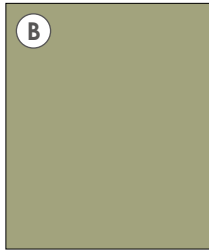
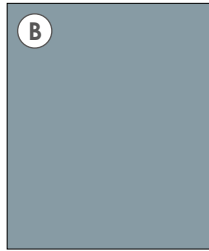
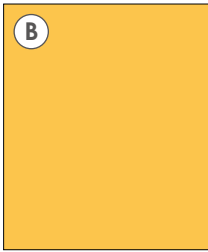
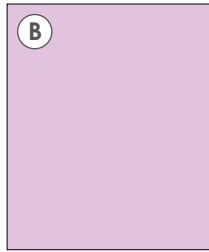
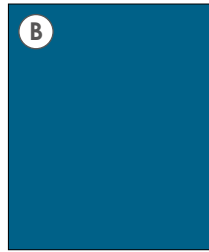

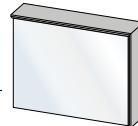

Rovere white*

 Rovere white RW3Q	 Rovere gesso RG9L	 Ciliegio bianco CB6K	 Grigio Dorian GL4R	 Cemento artico CA7A	 Rovere cognac RC3Q
 Royal oak RS4B	 Grigio titanio GZ8T	 Oliva LV5T	 Cadaques CQ3Q		
 Bianco opaco B17A	 Giallo zafferano GZ8A	 Albicocca AB3C	 Orchidea OR7L	 Blu Egeo EG4L	

Vetri
Glass



Ante Doors
WINDOW

 Trasparente TR9M	 Trasparente fumé FT8P	 Stop sol ST6P	 Specchio SP7L	Colori telaio Frame colours	
				 Alluminio AL1A	 Titan grey TG7H

Rovere white* Finitura unica per tutti i componenti in pannello presenti a listino non evidenziati con il colore Finiture GRUPPO 1 e/o Finiture GRUPPO 2.
Unique finish for all the panel components shown in the pricelist not highlighted with the color finishes GROUP 1 and/or finishes GROUP 2.

- A Finiture in fascia di prezzo A
Finishes in price range A
- B Finiture in fascia di prezzo B
Finishes in price range B
- ★ Finiture con effetto materico
Finishes with textured effect

Tavola sinottica pomelli e maniglie













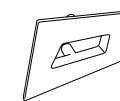

Knobs and handles synoptic table

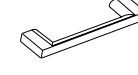
Passo mm: Span mm:		0	32	96	160	-													
		T01A G01M	H07L E74N E73K E72F	E34P E33K T03C T05M E16C	T04L G28P E76R E04U E36R	- - - H05Z H06B													
		FOL	P11	SEM	BING	DROP	MASK	BEN	VER	BIS	DER	GAB	LIG	PUL	PURA	SAK	VER	BLADE	TALL
	Alluminio	AL1A	●	●					●	●			●				●		
	Alluminio spazzolato	AS7H													●				
	Champagne spazzolato	CS4B													●				
	Nero spazzolato	NS3Q													●				
	Rovere white	RW3Q	●											●				●	
	Rovere gesso	RG9L												●				●	
	Ciliegio bianco	CB6K	●											●				●	
	Grigio Dorian	GL4R	●	●	●	●	●	●			●	●	●	●	●	●		●	●
	Rovere cognac	RC3Q												●				●	
	Royal oak	RS4B												●				●	
	Grigio titanio	GZ8T	●	●	●	●	●	●			●	●	●	●	●	●		●	●
	Oliva	LV5T	●		●	●	●	●			●	●			●				
	Cadaques	CQ3Q	●		●	●	●	●			●	●			●				
	Bianco opaco	BI7A	●	●	●	●	●	●	●	●	●	●	●	●	●	●	●	●	●
	Giallo zafferano	GZ8A	●		●	●	●	●			●	●			●				
	Albicocca	AB3C	●		●	●	●	●			●	●			●				
	Orchidea	OR7L	●		●	●	●	●			●	●			●				
	Blu Egeo	EG4L	●		●	●	●	●			●	●			●				

 Maniglie con foratura VERTICALE
Handles with VERTICAL drilling
 Maniglie con foratura ORIZZONTALE
Handles with HORIZONTAL drilling
● Colore disponibile
Available colour

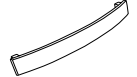
Sovrapprezzi maniglie

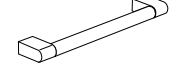
Handles surcharges

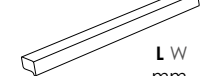
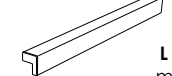
Passo mm: Span mm:	0	FOL	P11	SEM			
							
Sovrapprezzo Surcharge	0	0	0	0			
Passo mm: Span mm:	32	BING	DROP	MASK			
							
Sovrapprezzo Surcharge	0	0	0	0			
Passo mm: Span mm:	96	BEN	VER				
							
Sovrapprezzo Surcharge	0	0	0				
Passo mm: Span mm:	160	BIS	DER	GAB	LIG	PUL	PURA
							
Sovrapprezzo Surcharge	0	0	0	0	0	0	0
Passo mm: Span mm:	160	SAK	VER				
							
Sovrapprezzo Surcharge	0	0	0				
Passo mm: Span mm:	-	BLADE	TALL				
							
Sovrapprezzo Surcharge		L W mm	L W mm	L W mm			
		445	154	1594			
		595	314	1914			
		895	634	2234			
		1195	954	2554			
			1274				

Indice

Tables of contents

Certificazioni	pag. 4	Accessori per armadi con ante battenti	pag. 70	Reti a doghe	pag. 141	Accessori per componibili	pag. 202
Certifications		Wardrobes with hinged doors accessories		Slatted bed bases		Modular units accessories	
Indice generale dei colori	pag. 5	Cabine ad angolo ELLE	pag. 72	Materassi e guanciali	pag. 142	Pensili - P 32,5	pag. 204
General index of colors		ELLE corner walk-in wardrobes		Mattresses and pillows		Hanging units - Dpt 32.5	
Compilazione degli ordini con "T GEO - METRON4 - MULTISTANZA"	pag. 6	Cabine ad angolo ESSE	pag. 74	Gruppi	pag. 146	Accessori per pensili	pag. 206
Compilation of orders with "T GEO - METRON4 - MULTI-ROOM"		ESSE corner walk-in wardrobes		Groups		Hanging units accessories	
CARATTERISTICHE	pag. 9	Angoli interi per armadi - P 56,3	pag. 76	Specchiere	pag. 150	Moduli sospesi SNAKE	pag. 208
CHARACTERISTIC		Corner wardrobes - Dpt 56.3		Mirrors		SNAKE suspended modular units	
Colori, finiture	pag. 10	Terminali - P 56,3	pag. 77	SCRIVANIE, MENSOLE E CUBOLOTTI	pag. 153	RESIDENCE E HOTEL	pag. 213
Colors, finishes		End units - Dpt 56.3		DESKS, SHELVES AND CUBES		RESIDENCE AND HOTEL	
Tessuti, similpelli e microfibre	pag. 12	Librerie terminali ORDER - L 32,5 P 54,5 - con contenitore L 30 P 32,5	pag. 78	Scrivanie BANNER - H 77,6 P 57,1	pag. 154	Elementi per hotel e contract	pag. 214
Fabrics, faux leather and microfibers		ORDER end bookshelves - W 32.5 Dpt 54.5 - with cabinet W 30 Dpt 32.5		BANNER desks - Ht 77.6 Dpt 57.1		Contract and hotel elements	
Colori (non standard) per sedute	pag. 14	Librerie terminali OLA - L 30,7 P 53,6	pag. 79	Scrivanie WINNER - H 77,6 P 63,5	pag. 156	Testate continue su misura e letti accostabili	pag. 216
Colours (not standard) for seats		OLA end bookshelves - W 30.7 Dpt 53.6		WINNER desks - Ht 77.6 Dpt 63.5		Custom-made continuous headboards and his beds	
Colori ruote	pag. 15	Armadi con ante scorrevoli - H 225,3 P 61,5	pag. 80	Scrivanie SWITCH - H 77,6 P 63,3	pag. 158	Scheda prodotto	pag. 218
Wheel colours		Wardrobes with sliding doors - Ht 225.3 Dpt 61.5		SWITCH desks - Ht 77.6 Dpt 63.3		Product information	
Strutture a spalla per Armadi	pag. 16	Armadi con ante scorrevoli - H 257,3 P 61,5	pag. 82	Scrivanie ICS - H 77,6 P 57,1	pag. 160	Condizioni generali di vendita	pag. 220
Modular structure for Wardrobes		Wardrobes with sliding doors - Ht 257.3 Dpt 61.5		ICS desks - Ht 77.6 Dpt 57.1		General sales conditions	
Strutture per Armadi con ante scorrevoli	pag. 18	Accessori per armadi con ante scorrevoli	pag. 84	Scrivanie ALPA - H 77,6	pag. 161		
Structure for Wardrobes with sliding doors		Wardrobes with sliding doors accessories		ALPA desks - Ht 77.6			
Strutture ad elementi per Componibili a terra/in appoggio	pag. 20	Fasce di tamponamento	pag. 86	Scrivanie CORNER - H 77,6 P 90	pag. 162		
Element structures for floor/support Modular units		Filler strips		CORNER desks - Ht 77.6 Dpt 90			
Strutture ad elementi per Componibili sospesi e Pensili	pag. 22	Sistema COMBY - H 44,7 P 46,5	pag. 88	Accessori per scrivanie	pag. 163		
Element structures for Suspended modular units and Hanging units		COMBY system - Ht 44.7 Dpt 46.5		Desks accessories			
Facciate VOLO	pag. 24	ARMADI PONTE, LETTI A SOPPALCO E A CASTELLO	pag. 91	Mensole - Sp 2,5 P 26	pag. 164		
VOLO fronts		BRIDGE WARDROBES, LOFT AND BUNK BEDS		Shelves - Th 2.5 Dpt 26			
Ante WINDOW	pag. 26	Armadi a ponte - H 257,6 P 56,3	pag. 92	Cubolotti	pag. 166		
WINDOW doors		Bridge wardrobes - Ht 257.6 Dpt 56.3		Cubes			
Ante scorrevoli	pag. 28	Letti a soppalco BRIDGE - H 257,6 P 95 - per scaletta in metallo	pag. 94	PlayWood®	pag. 168		
Sliding doors		BRIDGE loft beds - Ht 257.6 Dpt 95 - for metal ladder		PlayWood®			
Lavorazioni particolari	pag. 30	Letti a soppalco BRIDGE - H 257,6 P 100 - con scaletta laterale	pag. 96	Composizioni con PlayWood® - P 44,7	pag. 169		
Special processes		BRIDGE loft beds - Ht 257.6 Dpt 100 - with side stair		Compositions with PlayWood® - Dpt 44.7			
MANIGLIE, ACCESSORI, SEDIE E TAVOLI	pag. 33	Accessori per armadi ponte e letti a soppalco	pag. 98	Pannelli attrezzati STRIP - P 20	pag. 170		
HANDLES, ACCESSORIES, CHAIRS AND TABLES		Bridge wardrobes and loft beds accessories		STRIP equipped panels - Dpt 20			
Pomelli e maniglie	pag. 34	Letti a castello WINNER - H 187 L 101,5 - per scaletta in metallo	pag. 100	Pannelli attrezzati BING - P 28,5	pag. 170		
Knobs and handles		WINNER bunk beds - Ht 187 W 101.5 - for metal ladder		BING equipped panels - Dpt 28.5			
Posizionamento pomelli e maniglie	pag. 40	Letti a castello WINNER - H 187 L 101,5 - con scaletta laterale	pag. 101	Pannelli attrezzati DROP - P 20,5	pag. 170		
Knobs and handles position		WINNER bunk beds - Ht 187 W 101.5 - with side stair		DROP equipped panels - Dpt 20.5			
Ferramenta	pag. 42	Letti a castello REVOLUTION - H 198 L 210	pag. 102	Pannelli attrezzati EXPILON - P 28,5	pag. 171		
Hardware		REVOLUTION bunk beds - Ht 198 W 210		EXPILON equipped panels - Dpt 28.5			
Campionari e vernici	pag. 44	Letti a castello REVOLUTION - H 198 L 210 - con cabina	pag. 104	Pannelli attrezzati STRANGE - H 90	pag. 172		
Colour sample sets and paints		REVOLUTION bunk beds - Ht 198 W 210 - with walk-in wardrobe		STRANGE equipped panels - Ht 90			
Pannelli e bordi	pag. 44	Letti a castello REVOLUTION - H 198 L 210 - con armadio	pag. 106	Pannelli attrezzati porta TV - H 90	pag. 173		
Panels and edged		REVOLUTION bunk beds - Ht 198 W 210 - with wardrobe		Equipped panels for TV - Ht 90			
Illuminazione	pag. 45	Accessori per letti a castello REVOLUTION	pag. 108	LIBRERIA INFINITY	pag. 175		
Lighting		REVOLUTION bunk beds accessories		INFINITY BOOKSHELF			
Appendiabiti	pag. 45	Letti a castello TITANO - H 179,3 L 200	pag. 110	Libreria INFINITY - Informazioni tecniche	pag. 176		
Clothes hook		TITANO bunk beds - Ht 179.3 W 200		INFINITY bookshelf - Technical information			
Sedie	pag. 46	LETTI E GRUPPI	pag. 113	Libreria INFINITY - Ante e cassette	pag. 180		
Chairs		BEDS AND GROUPS		INFINITY bookshelf - Doors and drawers			
Tavoli DALLAS	pag. 47	Letti singoli	pag. 114	Libreria INFINITY - H 195,3 P 33,3	pag. 182		
DALLAS tables		Single beds		INFINITY bookshelf - Ht 195.3 Dpt 33.3			
Ante	pag. 48	Letti singoli imbottiti	pag. 122	Libreria INFINITY - H 227,3 P 33,3	pag. 184		
Doors		Padded single beds		INFINITY bookshelf - Ht 227.3 Dpt 33.3			
Cassetti e cassettoni VOLO	pag. 51	Turche	pag. 124	Libreria INFINITY - H 259,3 P 33,3	pag. 186		
VOLO drawers and big drawers		Ottomans		INFINITY bookshelf - Ht 259.3 Dpt 33.3			
Pannello anta VOLO senza fori cerniera e maniglia	pag. 52	Divani letto	pag. 126	Libreria INFINITY - Schiene, ripiani e accessori	pag. 188		
VOLO door panel without hinge and handle holes		Sofa beds		INFINITY bookshelf - Backs, shelves and accessories			
ARMADI CON ANTE BATTENTI E SCORREVOLI	pag. 55	Letti matrimoniali	pag. 128	Libreria INFINITY angolo intero - P 33,3	pag. 190		
WARDROBES WITH HINGED AND SLIDING DOORS		Double beds		Full corner INFINITY bookshelf - Dpt 33.3			
Armadi con ante battenti - H 225,6 P 56,3	pag. 56	Letti matrimoniali imbottiti	pag. 136	Libreria INFINITY terminale - P 33,3	pag. 191		
Wardrobes with hinged doors - Ht 225.6 Dpt 56.3		Padded double beds		End-bookshelf INFINITY - Dpt 33.3			
Armadi con ante battenti - H 257,6 P 56,3	pag. 62	Letti scorrevoli NEW ROLL	pag. 138	COMPONIBILI E PENSILI	pag. 193		
Wardrobes with hinged doors - Ht 257.6 Dpt 56.3		NEW ROLL sliding beds		MODULAR UNITS AND HANGING UNITS			
Armadi porta TV con ante battenti - P 56,3	pag. 68	Letti scorrevoli EDGE	pag. 139	Componibili a terra/in appoggio - P 45,8	pag. 194		
TV wardrobes with hinged doors - Dpt 56.3		EDGE sliding beds		Floor/support modular units - Dpt 45.8			
Elementi JOLLY	pag. 69	Accessori per letti	pag. 140	Componibili sospesi - P 45,8	pag. 200		
JOLLY elements		Beds accessories		Suspended modular units - Dpt 45.8			

UNI EN ISO 14001



UNI EN ISO 9001



In ordine alfabetico:
In alphabetical order:

Codici colore
Colour codes

0021	Tela	X31H	Azzurro	• A	Albicocca	AB3C	Opale	Z85V
0025	Bianco	X32M	Blu	AB3C	Alluminio	AL1A	Oran	OR1S
0031	Grigio oliva	• Y		AL1A	Alluminio spazzolato	AS7H	Orchidea	OR7L
0402	Zinc	Y33R	Panna	AS7H	Arancia	Z15L	Panna	Y33R
0403	Papyrus	• Z		Z15L	Arancio	Z02K	Papyrus	0403
0503	Carioca	Z01B	Bianco	Z02K	Arancio Runner	Z75N	• R	
0601	Grey	Z13K	Limone	Z75N	Argento	AR3T	Rosa	Z66H
0604	Greystone	Z14G	Viola	AR3T	Azzurro	X31H	Rovere cognac	RC3Q
0704	Smoke	Z15L	Arancia	X31H	Beige	X28D	Rovere Dorian	RD5T
0706	Steel	Z16R	Blu pervinca	X28D	Beige Runner	Z76R	Rovere gesso	RG9L
0903	Nox	Z17W	Fucsia	Z76R	Bianco	0025	Rovere white	RW3Q
• A		Z20B	Bianco candido	0025	Bianco	BN7A	Royal oak	RS4B
AB3C	Albicocca	Z21R	Limo	BN7A	Bianco	Z01B	• S	
AL1A	Alluminio	Z35F	Verde eden	Z01B	Bianco candido	Z20B	Smoke	0704
AR3T	Argento	Z41G	Travertino	Z20B	Bianco opaco	BI7A	Senape	Z79Y
AS7H	Alluminio spazzolato	Z62R	Fiordaliso	BI7A	Blu	X32M	Specchio	SP7L
• B		Z63U	Malva	X32M	Blu Egeo	EG4L	Steel	0706
BI7A	Bianco opaco	Z64X	Elephant	EG4L	Blu pervinca	Z16R	Stop sol	ST6P
BL6R	Blue	Z66H	Riso	Z16R	Blu petrolio	Z70R	• T	
BN7A	Bianco	Z67M	Duna	Z70R	Blu Runner	Z77U	Tabacco	Z68Q
BT4R	Trasparente	Z68Q	Tabacco	Z77U	Blue	BL6R	Tela	0021
• C		Z69T	Vinaccia	BL6R	• C		Titano	Z82L
CA7A	Cemento artico	Z70R	Blu petrolio		Cadaques	CQ3Q	Titan grey	TG7H
CB6K	Ciliegio bianco	Z71U	Grigio medio	CQ3Q	Carioca	0503	Trasparente	BT4R
CQ3Q	Cadaques	Z75N	Arancio Runner	0503	Cemento artico	CA7A	Trasparente	TR9M
CS4B	Champagne spazzolato	Z76R	Beige Runner	CA7A	Champagne spazzolato	CS4B	Trasparente fumè	FT8P
• E		Z77U	Blu Runner	CS4B	Ciliegio bianco	CB6K	Travertino	Z41G
EG4L	Blu Egeo	Z78X	Grigio Runner	CB6K	• D		• V	
• F		Z79Y	Senape		Desert	Z81G	Verde	VE5R
FT8P	Trasparente fumè	Z80B	Dorian		Domy	Z83P	Verde eden	Z35F
• G		Z81G	Desert		Dorian	Z80B	Vinaccia	Z69T
GL4R	Grigio Dorian	Z83P	Domy		Duna	Z67M	Viola	Z14G
GZ8A	Giallo zafferano	Z84S	Zafferano		• E		• Z	
GZ8T	Grigio titanio	Z85V	Opale		Elephant	Z64X	Zafferano	Z84S
• L		Z82L	Titano		• F		Zinc	0402
LV5T	Oliva				Fiordaliso	Z62R		
• N					Fucsia	Z17W		
NS3Q	Nero spazzolato				• G			
• O					Giallo	X29G		
OR1S	Oran				Giallo zafferano	GZ8A		
OR7L	Orchidea				Grey	0601		
• R					Greystone	0604		
RC3Q	Rovere cognac				Grigio	X22K		
RD5T	Rovere Dorian				Grigio Dorian	GL4R		
RG9L	Rovere gesso				Grigio medio	Z71U		
RS4B	Royal oak				Grigio oliva	0031		
RS8X	Rosa				Grigio Runner	Z78X		
RW3Q	Rovere white				Grigio titanio	GZ8T		
• S					• L			
SP7L	Specchio				Lime	X27A		
ST6P	Stop sol				Limo	Z21R		
• T					Limone	Z13K		
TG7H	Titan grey				• M			
TR9M	Trasparente				Malva	Z63U		
• V					• N			
VE5R	Verde				Nero spazzolato	NS3Q		
• X					Nox	0903		
X22K	Grigio				• O			
X27A	Lime				Oliva	LV5T		
X28D	Beige							
X29G	Giallo							

Compilazione degli ordini con "T GEO – METRON4 – MULTISTANZA"

Compilation of orders with "T GEO – METRON4 – MULTI-ROOM"

Utilizzare il Colombini Software System permette di:

- Generare preventivi e disegni chiari e corretti.
- Disegnare un'ambientazione reale della composizione.
- Progettare rapidamente un appartamento con tutte le collezioni del Gruppo Colombini.
- Creare progetti che sanno emozionare.
- Ridurre i tempi per lo sviluppo e invio ordini alla Colombini S.p.A.
- Utilizzare lo stesso programma impiegato in Colombini S.p.A.
- Spedire gli ordini tramite Internet garantendone la tracciabilità.
- Disporre dei listini elettronici aggiornati in tempo reale.
- Organizzare in modo flessibile e personalizzato i propri progetti.

With the Colombini Software System you can:

- Generate clear, accurate cost estimates and drawings.
- Draw a real rendering of the composition.
- Quickly design an apartment with all the Colombini Group collections.
- Create exciting designs.
- Cut times for developing orders and dispatching them to Colombini S.p.A.
- Use the same programme as Colombini S.p.A. itself.
- Send orders by Internet, with traceability ensured.
- Access electronic price-lists updated in real time.
- Organise your projects in a flexible way, customised to your needs.

Le immagini e i prezzi hanno valore puramente illustrativo.

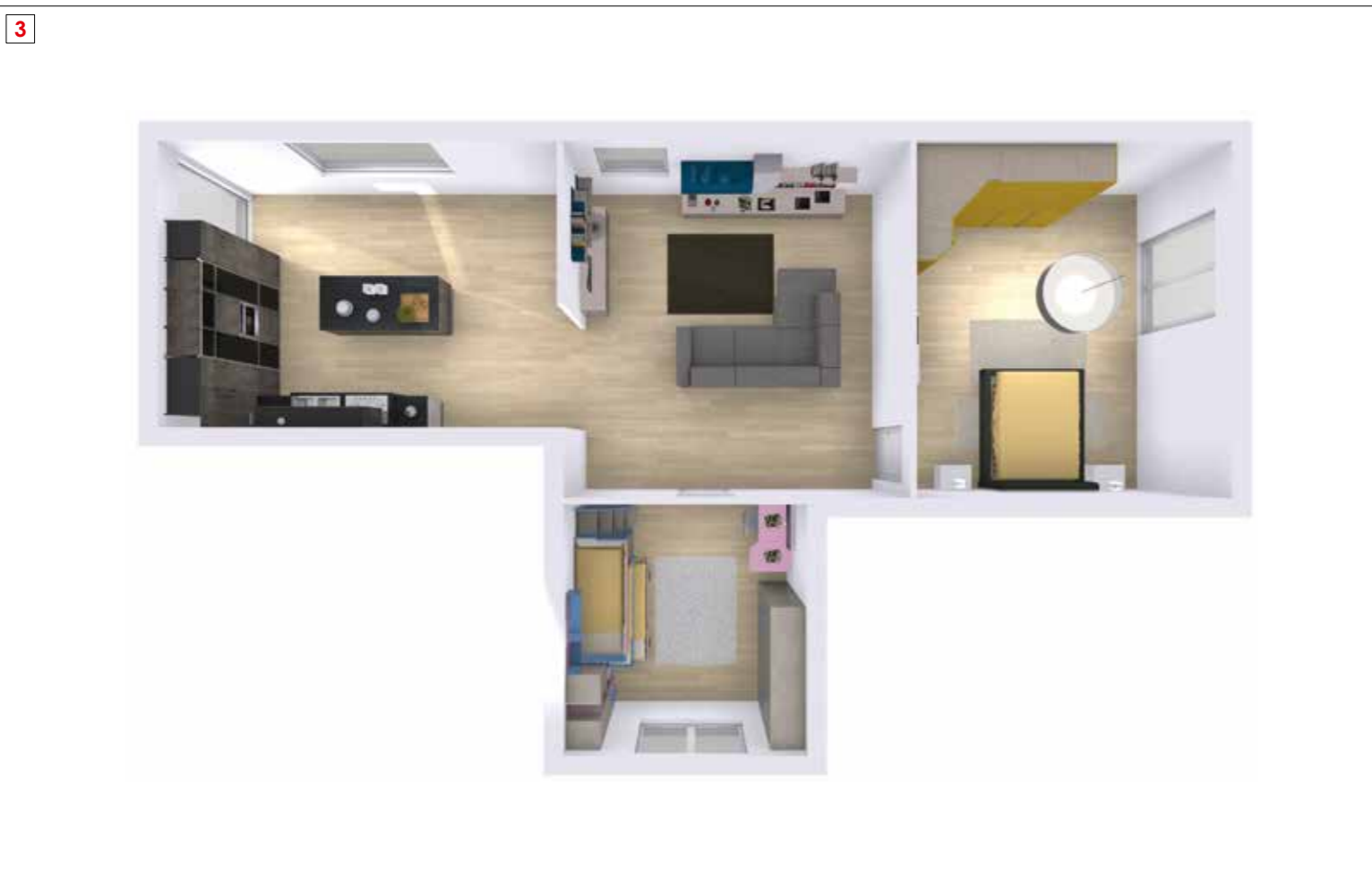
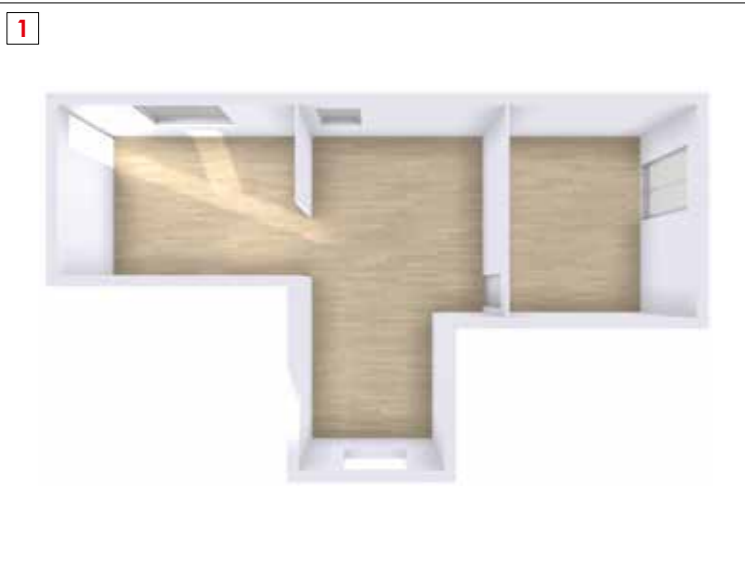

- 1** Creazione ambiente "Metron4"
Creating a "Metron4" room
- 2** Inserimento progetti nell'ambiente creato "Metron4"
Loading projects into the "Metron4" room created
- 3** Vista finale dell'appartamento "Metron4"
"Metron4" apartment final view

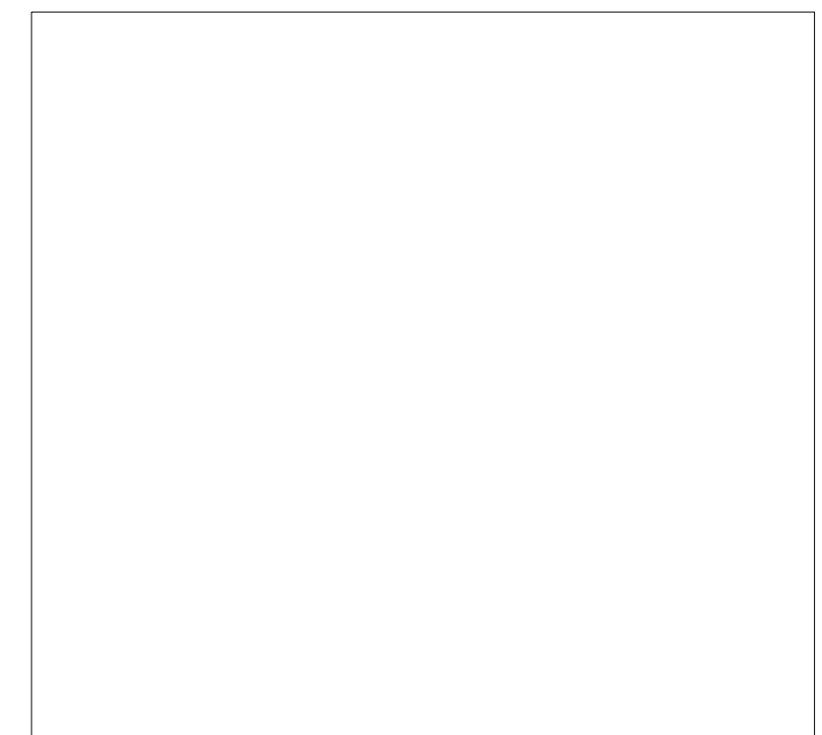
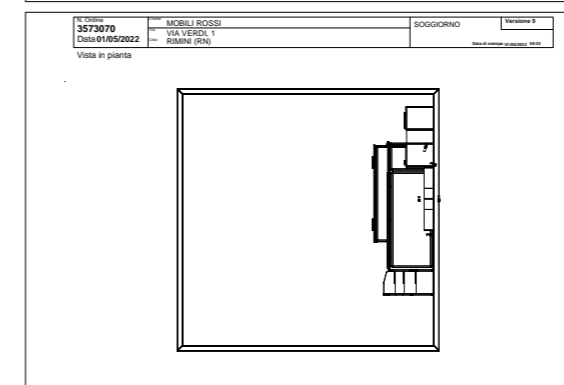
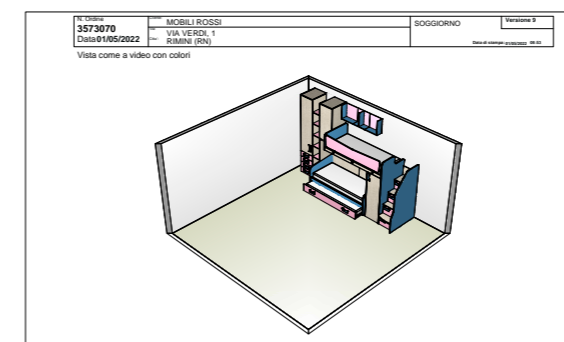

- 4** Impaginazione progetto completo "T-Print"
Complete "T-Print" project page layout
- 5** Rendering pianta "T-Rend"
"T-Rend" ground plan rendering
- 6** Rendering composizione "T-Rend"
"T-Rend" composition rendering

Per comprendere meglio le descrizioni degli articoli nei documenti
In order to better understand item descriptions in documents

Altezze:	Heights:
H 225,6 = H 7	H† 225.6 = H† 7
H 257,6 = H 8 (armadi con ante battenti e ponti)	H† 257.6 = H† 8 (wardrobes with hinged doors and overhead compositions)
H 225,3 = H 7	H† 225.3 = H† 7
H 257,3 = H 8 (armadi con ante scorrevoli)	H† 257.3 = H† 8 (wardrobes with sliding doors)
H 195,3 = H 6	H† 195.3 = H† 6
H 227,3 = H 7	H† 227.3 = H† 7
H 259,3 = H 8 (librerie INFINITY)	H† 259.3 = H† 8 (INFINITY bookshelves)
H 32 = H 1	H† 32 = H† 1
H 64 = H 2	H† 64 = H† 2
H 96 = H 3	H† 96 = H† 3
H 128 = H 4 (componibili)	H† 128 = H† 4 (modular units)
H 32 = H 1	H† 32 = H† 1
H 96 = H 3	H† 96 = H† 3
H 128 = H 4	H† 128 = H† 4
H 160 = H 5 (pensili)	H† 160 = H† 5 (hanging units)

Profondità:	Depths:
P 61,5 = PA (armadi con ante scorrevoli)	Dpt 61.5 = PA (wardrobes with sliding doors)
P 56,3 = PA (armadi e ponti)	Dpt 56.3 = PA (wardrobes and overhead compositions)
P 45,8 = PB (componibili)	Dpt 45.8 = PB (modular units)
P 32,5 = PC (pensili)	Dpt 32.5 = PC (hanging units)
P 33,3 = PC (librerie INFINITY)	Dpt 33.3 = PC (INFINITY bookshelves)

Legenda codici colore:
Colour code legend:

0021 Tela	CQ3Q Cadaques	VE5R Verde	Z64X Elephant
0025 Bianco	CS4B Champagne spazzolato	X22K Grigio	Z66H Riso
0031 Grigio oliva	EG4L Blu Egeo	X27A Lime	Z67M Duna
0402 Zinc	FT8P Trasparente fumè	X28D Beige	Z68Q Tabacco
0403 Papyrus	GL4R Grigio Dorian	X29G Giallo	Z69T Vinaccia
0503 Carioca	GZ8A Giallo zafferano	X31H Azzurro	Z70R Blu petrolio
0601 Grey	GZ8T Grigio titanio	X32M Blu	Z71U Grigio medio
0604 Greystone	LV5T Oliva	Y33R Panna	Z75N Arancio Runner
0704 Smoke	NS3Q Nero spazzolato	Z01B Bianco	Z76R Beige Runner
0706 Steel	OR1S Oran	Z02K Arancio	Z77U Blu Runner
0903 Nox	OR7L Orchidea	Z13K Limone	Z78X Grigio Runner
AB3C Albicocca	RC3Q Rovere cognac	Z14G Viola	Z79Y Senape
AL1A Alluminio	RD5T Rovere Dorian	Z15L Arancia	Z80B Dorian
AR3T Argento	RG9L Rovere gesso	Z16R Blu pervinca	Z81G Desert
AS7H Alluminio spazzolato	RS4B Royal oak	Z17W Fucsia	Z83P Domy
BI7A Bianco opaco	RS8X Rosa	Z20B Bianco candido	Z84S Zafferano
BL6R Blue	RW3Q Rovere white	Z21R Limo	Z85V Opale
BN7A Bianco	SP7L Specchio	Z35F Verde eden	Z82L Titanio
BT4R Trasparente	ST6P Stop sol	Z41G Travertino	
CA7A Cemento artico	TG7H Titan grey	Z62R Fiordaliso	
CB6K Ciliegio bianco	TR9M Trasparente	Z63U Malva	

CARATTERISTICHE
CHARACTERISTIC

Colori, finiture Colors, finishes	pag. 10
Tessuti, similpelli e microfibre Fabrics, faux leather and microfibers	pag. 12
Colori (non standard) per sedute Colours (not standard) for seats	pag. 14
Colori ruote Wheel colours	pag. 15
Strutture a spalla per Armadi Modular structure for Wardrobes	pag. 16
Strutture per Armadi con ante scorrevoli Structure for Wardrobes with sliding doors	pag. 18
Strutture ad elementi per Componibili a terra/in appoggio Element structures for floor/support Modular units	pag. 20
Strutture ad elementi per Componibili sospesi e Pensili Element structures for Suspended modular units and Hanging units	pag. 22
Facciate VOLO VOLO fronts	pag. 24
Ante WINDOW WINDOW doors	pag. 26
Ante scorrevoli Sliding doors	pag. 28
Lavorazioni particolari Special processes	pag. 30



Rovere white
RW3Q



Rovere gesso
RG9L



Ciliegio bianco
CB6K

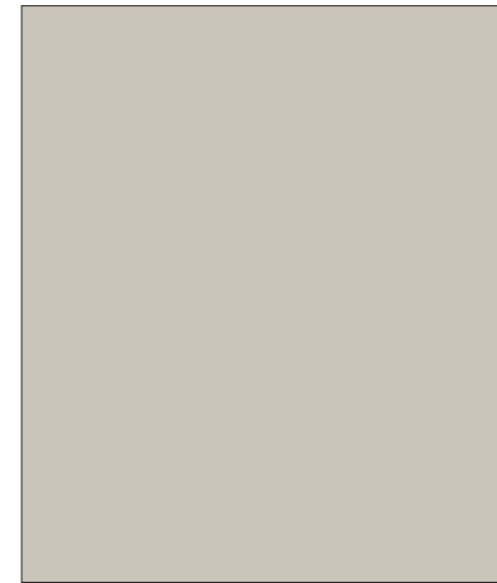

Grigio Dorian
GL4R

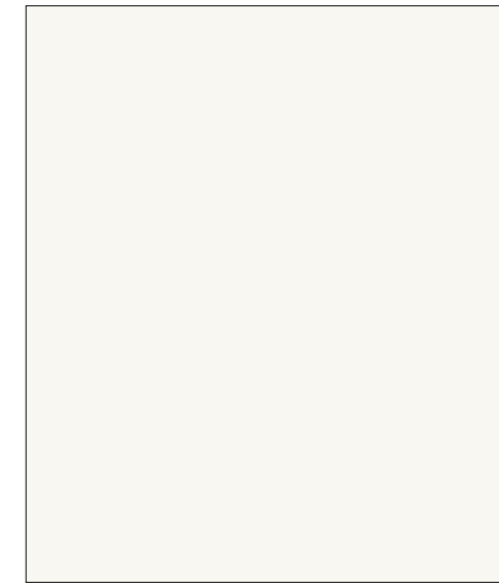

Bianco opaco
BI7A



Cemento artico
CA7A



Rovere cognac
RC3Q



Royal oak
RS4B



Grigio titanio
GZ8T



Oliva
LV5T



Cadaques
CQ3Q

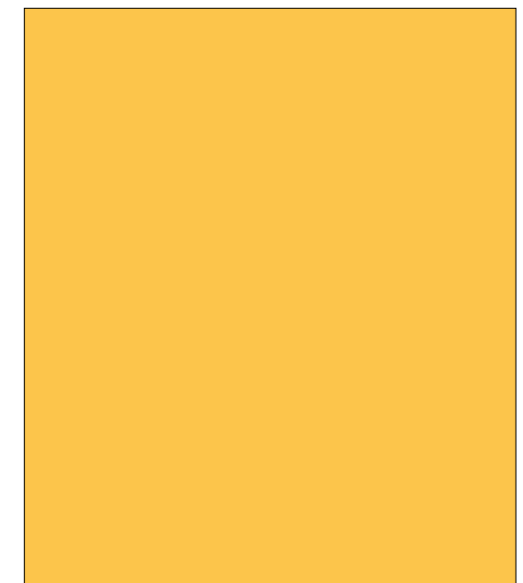

Giallo zafferano
GZ8A

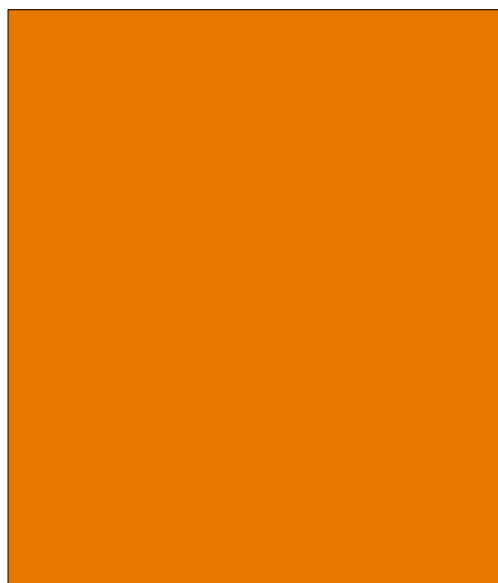

Albicocca
AB3C

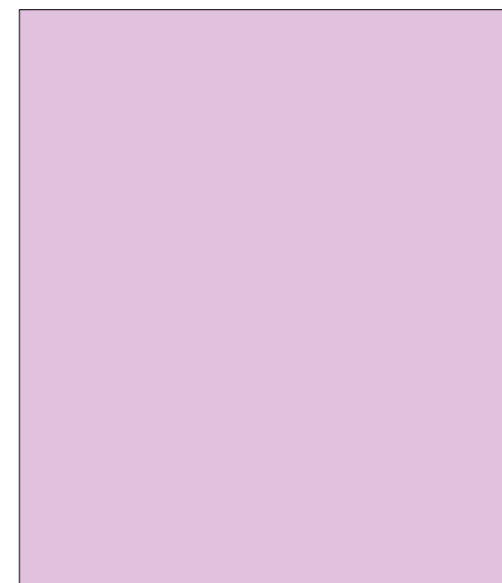

Orchidea
OR7L



Blu Egeo
EG4L



- (A) **Finiture in fascia di prezzo A**
Finishes in price range A
- (B) **Finiture in fascia di prezzo B**
Finishes in price range B
- (★) **Finiture con effetto materico**
Finishes with textured effect

Rivestimento
Covering

TESSUTO
FABRIC
JENNY
RV24JN



TESSUTO
FABRIC
ECOCHIC

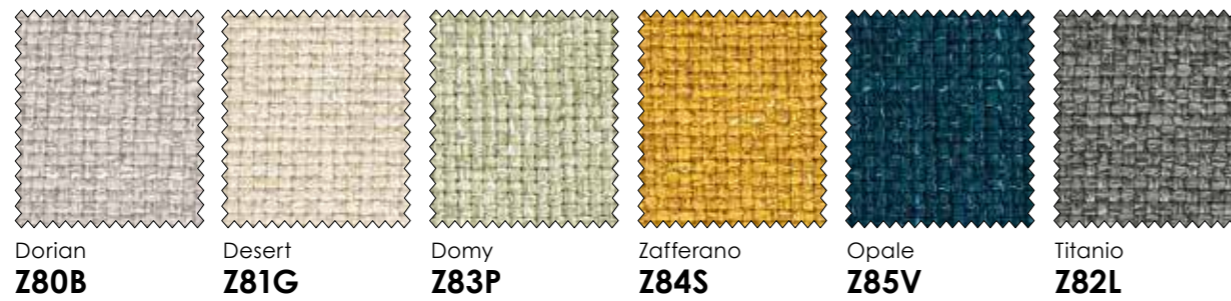

SIMILPELLE
FAUX LEATHER
ECOCHIC

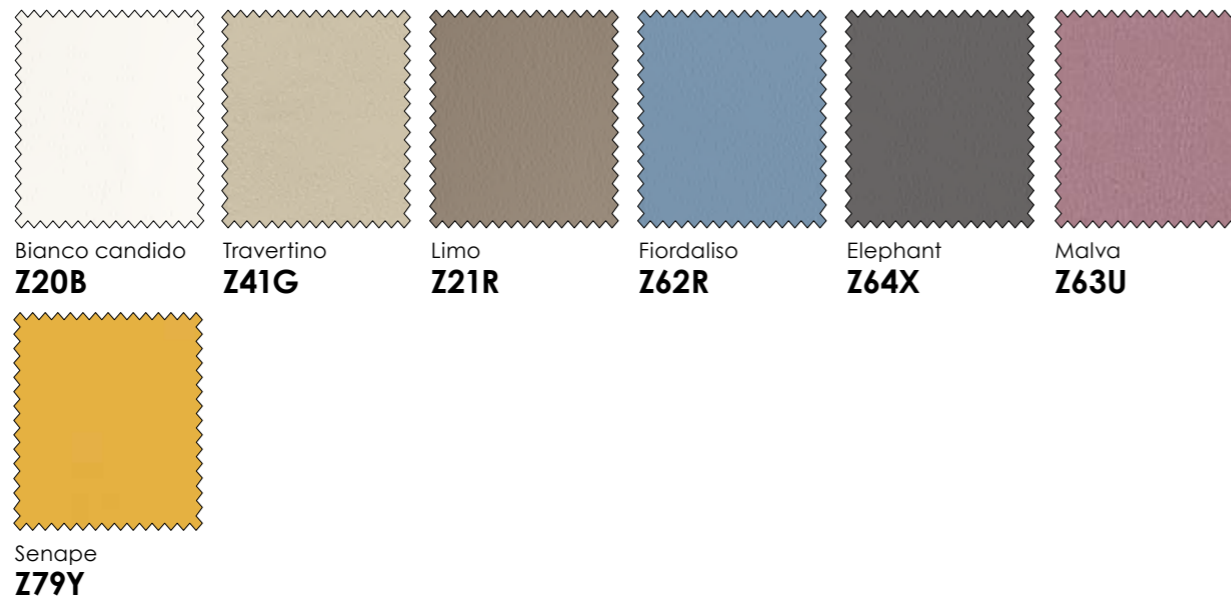

MICROFIBRA
MICROFIBRE
ECOCHIC



Idrorepellente antimacchia. Grazie a tale trattamento, i liquidi o le sostanze che accidentalmente possono cadere sul rivestimento, non penetrano nel tessuto e non vengono assorbiti dalla gomma del cuscino. Nel caso si versi accidentalmente una soluzione acquosa (acqua, vino, caffè, bibite, ecc.) è sufficiente asciugare con un panno asciutto o carta assorbente. Nel caso in cui il liquido sia rimasto a lungo sul tessuto o abbia subito una eccessiva pressione, dopo aver asciugato, sarà necessario strofinare leggermente con una spugna umida non abrasiva. Nei casi più gravi si potrà utilizzare sapone neutro, successivamente da risciacquare.

Water-repellent stain. Thanks to this treatment, liquids or substances that may accidentally fall on the coating, will not penetrate into the fabric and will not be absorbed by the rubber in the cushion. In case you accidentally spill a watery solution (water, wine, coffee, soft drinks, etc.) it is enough to dry it with a dry cloth or paper towels. In the case the substance remains on the fabric for a prolonged amount of time or has suffered excessive pressure, after having been dried, you will need to rub gently with a damp non-abrasive sponge. In severe cases, you can use mild soap, subsequently rinse afterwards.

Rivestimenti selezionati dalla collezione SOFUP.
Selected coatings from the collection SOFUP.

Ignifugo CLASSE 1 (UNO)
Fireproof 1 CLASS (ONE)

Consegna 4 settimane circa dal ricevimento dell'ordine.
Delivery approximately 4 weeks from order receipt.

Il rivestimento, al momento del disimballaggio o in seguito ad un utilizzo anomalo, potrebbe presentare delle vistose macchie o righe dovute allo schiacciamento delle fibre. Utilizzare una spazzola con setole morbide per riportarlo alla naturalezza originaria.
At the time of unpacking or following incorrect use, the covering may display visible blotches or lines caused by crushed fibres. Use a brush with soft bristles to return the cover to its original appearance.

	Composizione: Composition:	Peso: Weight:	Martindale: Martindale:	Indicazioni per il lavaggio: Washing instructions:
TESSUTO FABRIC JENNY - RV24JN	poliestere polyester	100% 375 gr/m ²	60,000	
TESSUTO FABRIC ECOCHIC	poliestere polyester	100% 350 gr/m ²	> 100,000	
SIMILPELLE FAUX LEATHER ECOCHIC	poliestere polyester	100% 190 gr/m ²	-	 Pulire con panno morbido ed umido, delicatamente. Non usare abrasivi, detersivi chimici o sgrassatori. L'utilizzo di questi prodotti rovinerebbe irrimediabilmente il rivestimento. Clean gently with damp, soft cloth. Do not use abrasive and degreasing products or chemical detergents, which may ruin irremediably the upholstery.
MICROFIBRA MICROFIBRE ECOCHIC	poliestere polyester	100% 350 ± 5% gr/m ²	40,000	 Infiammabilità - L'articolo è conforme alle seguenti norme: Fire resistance - This product has been successfully tested according to the following methods: · Classe 1 IM (UNI 9175) · EN 1021-1:2006 & EN 1021-2:2006 · BS 5852 PART 0 & 1:1979 · CRIB 5 BS 5852:2006

I colori sono soggetti a cambiamenti di tono tra bagni diversi. Il produttore si riserva di modificare, in qualsiasi momento e senza preavviso, le specifiche del prodotto.
Colors may vary from lot to lot. The producer reserves the right to modify, at any moment and without notice, the technical specifications of their products.

Questi valori sono dati a titolo indicativo ed in buona fede e non possono essere considerati in alcun caso vincolanti.

These indications are merely guidelines and are provided in good faith; they may not be considered binding in any circumstance.

Colori (non standard) per sedute Colours (not standard) for seats

1 POLIPROPILENE TERMOFORMATO THERMOFORMED POLYPROPYLENE

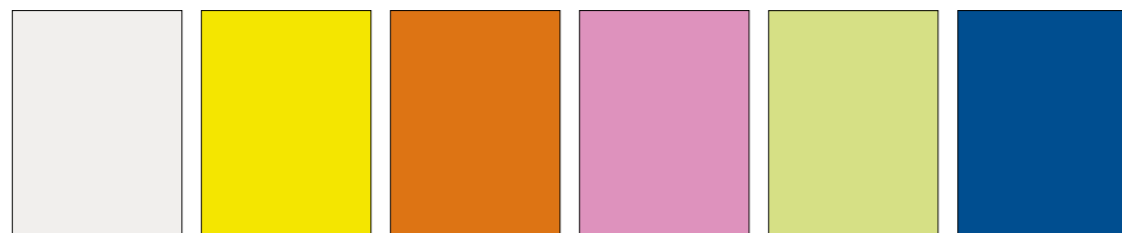

Panna **Y33R** Limone **Z13K** Arancia **Z15L** Viola **Z14G** Verde eden **Z35F** Blu pervinca **Z16R**

2 PLASTICA ATOSSICA NON-TOXIC PLASTIC

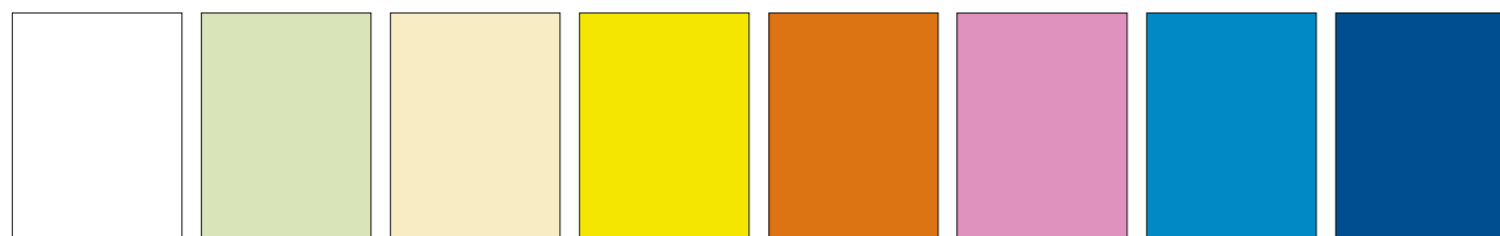

Bianco **Z01B** Lime **X27A** Beige **X28D** Giallo **X29G** Arancio **Z02K** Fucsia **Z17W** Azzurro **X31H** Blu **X32M**

3 POLIPROPILENE TERMOFORMATO THERMOFORMED POLYPROPYLENE

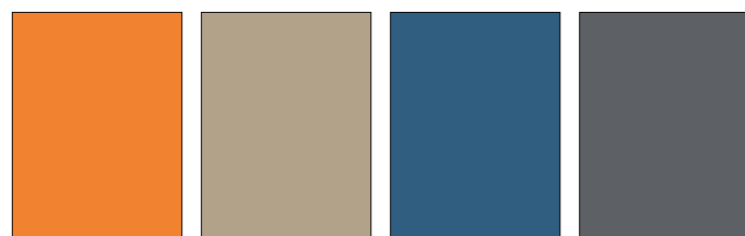

Arancio Runner **Z75N** Beige Runner **Z76R** Blu Runner **Z77U** Grigio Runner **Z78X**

4 POLIPROPILENE POLYPROPYLENE

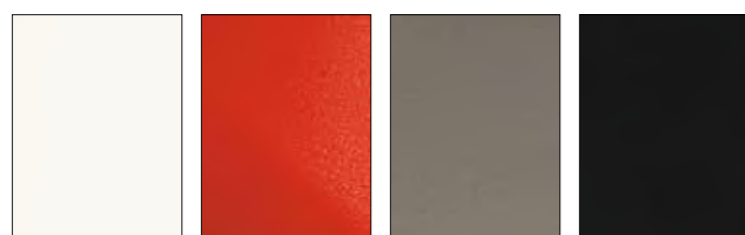

Bianco ottico Rosso Tortora Nero



Idrorepellente antimacchia.
Water-repellent stain.
 Rivestimenti selezionati dalla collezione SOFUP.
Selected coatings from the collection SOFUP.

5 TESSUTO FABRIC RITUAL - RV26RT

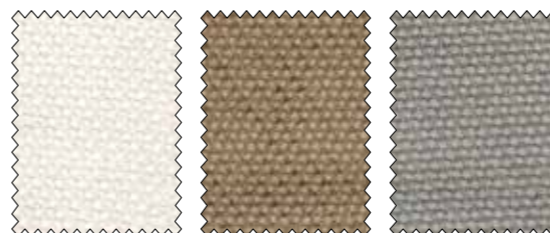

Bianco **0025** Tela **0021** Grigio oliva **0031**

6 TESSUTO FABRIC



Grigio **X22K**

Colori ruote Wheel colours

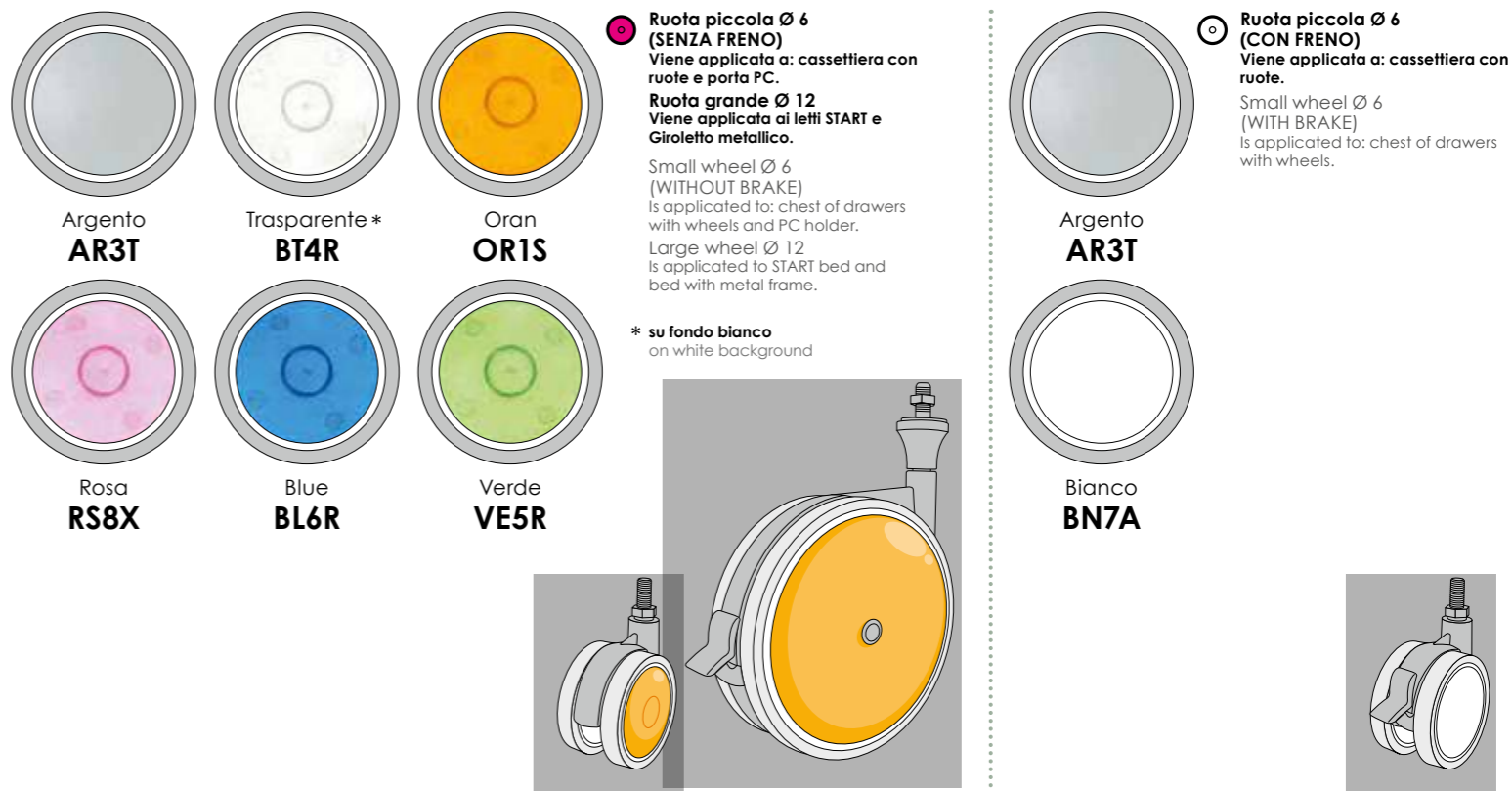

Strutture a spalla per Armadi

Modular structure for Wardrobes

Rovere white

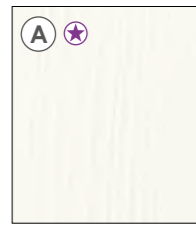

Finitura unica per tutti i componenti in pannello presenti a listino non evidenziati con il colore Finiture GRUPPO 1 e/o Finiture GRUPPO 2.

Unique finish for all the panel components shown in the pricelist not highlighted with the color finishes GROUP 1 and/or finishes GROUP 2.

Rovere white
RW3Q

Finiture GRUPPO 1
GROUP 1 finishes

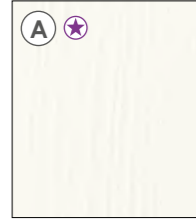

Rovere white
RW3Q

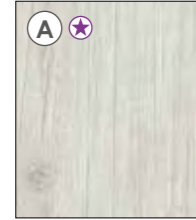

Rovere gesso
RG9L

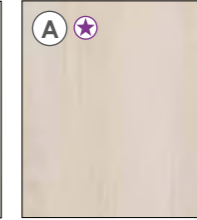

Ciliegio bianco
CB6K

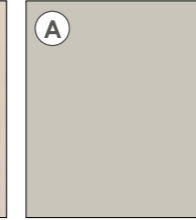

Grigio Dorian
GL4R

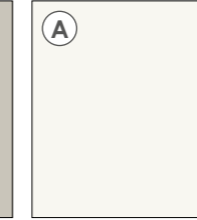

Bianco opaco
BI7A

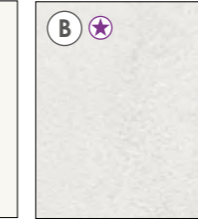

Cemento artico
CA7A

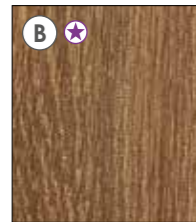

Rovere cognac
RC3Q

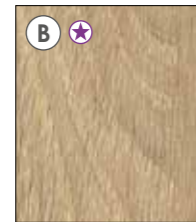

Royal oak
RS4B

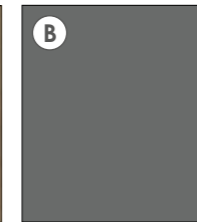

Grigio titanio
GZ8T

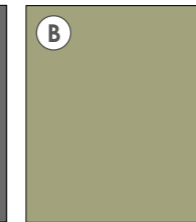

Oliva
LV5T

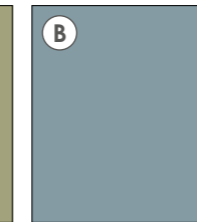

Cadaques
CQ3Q

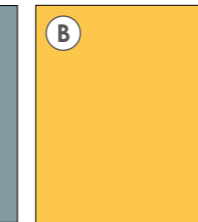

Giallo zafferano
GZ8A

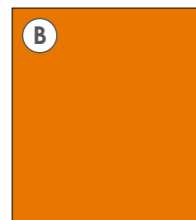

Albicocca
AB3C

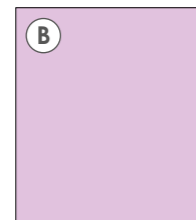

Orchidea
OR7L

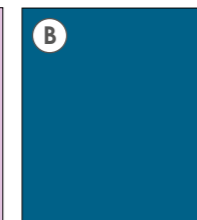

Blu Egeo
EG4L

Caratteristiche

Characteristics

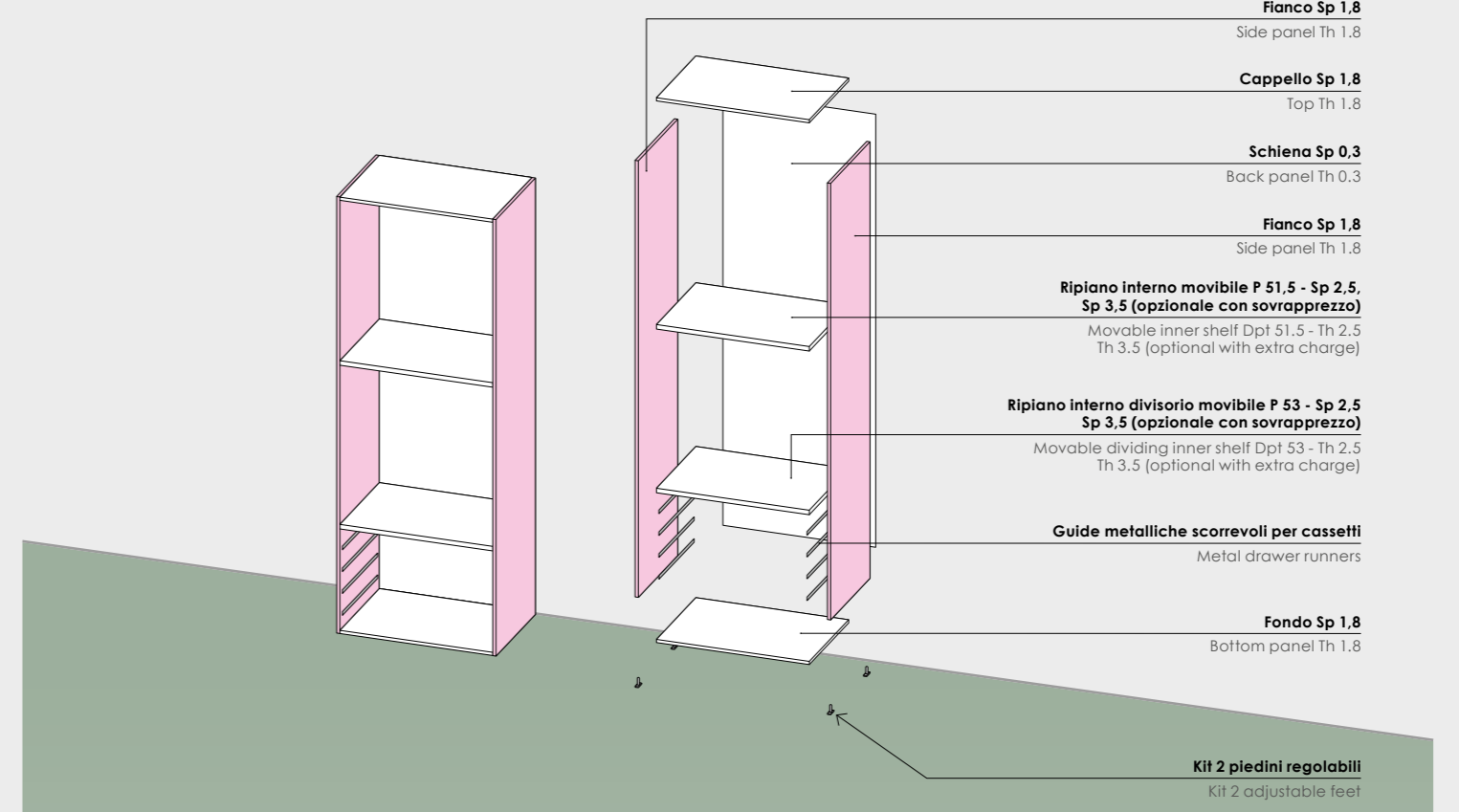

Importante:

- Fianco centrale, cappello, fondo, ripiani e schiena in finitura **Rovere white (RW3Q)**.
- Sono strutture posizionabili solo a terra.
- Sono dotate di piedini regolabili.
- I fianchi sono predisposti per il montaggio della ferramenta di ante, cassetti, ripiani.

Dotazione interna:

- Gli elementi a giorno sono dotati di ripiani ogni 32 cm.
- Negli armadi in corrispondenza di ante H 224 e H 256 sono presenti 1 ripiano interno e 2 tubi appendi abiti.
- Negli armadi con ante H 96, 128, 160 e 192 è presente un tubo appendiabiti.

Utilizzata per:

ARMADI
L 30 - 45 - 60 - 90 (fianco iniziale compreso)
P 56,3
H 225,6 - 257,6 (piedini H 0,7 compresi)

Important:

- Middle panel, top, bottom panel, shelves and back panel in **Rovere white (RW3Q)** finish.
- These structures can only be placed on the ground.
- They are fitted with adjustable feet.
- The side panels are prefitted to take the hardware of doors, drawers, shelves.

Element equipment

- Open elements are fitted with shelves every 32 cm.
- In the wardrobes in correspondence of doors Ht 224 and Ht 256 there are 1 inner shelf and 2 clothes hanging bars.
- In the wardrobes in correspondence of doors Ht 96, 128, 160, and 192 there is 1 clothes hanging bar.

Used for:

WARDROBES
W 30 - 45 - 60 - 90 (starting side panel included)
Dpt 56.3
Ht 225.6 - 257.6 (Ht 0.7 feet included)

Esempio composizione

Example of composition

- Ogni composizione deve essere completata dal fianco finale.
- In composizioni con altezze diverse, ogni elemento dovrà essere completato dal fianco finale.

- The compositions must be completed with an end side panel.
- In compositions with different heights, each element must be completed by the end side panel.

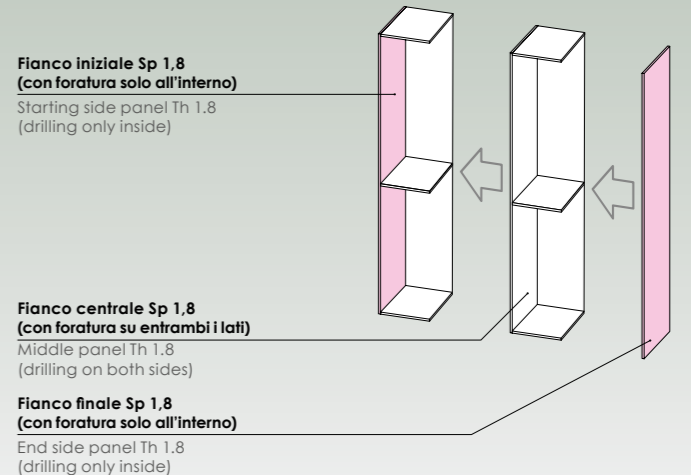

- A** Finiture in fascia di prezzo A
Finishes in price range A
- B** Finiture in fascia di prezzo B
Finishes in price range B
- ☆** Finiture con effetto materico
Finishes with textured effect

Strutture per Armadi con ante scorrevoli

Structure for Wardrobes with sliding doors

Rovere white

RW3Q

A ☆

Finitura unica per tutti i componenti in pannello presenti a listino non evidenziati con il colore Finiture GRUPPO 1 e/o Finiture GRUPPO 2.

Unique finish for all the panel components shown in the pricelist not highlighted with the color finishes GROUP 1 and/or finishes GROUP 2.

Finiture GRUPPO 1
GROUP 1 finishes

A ☆ Rovere white RW3Q	A ☆ Rovere gesso RG9L	A ☆ Ciliegio bianco CB6K	A Grigio Dorian GL4R	A Bianco opaco BI7A	B ☆ Cemento artico CA7A
B ☆ Rovere cognac RC3Q	B ☆ Royal oak RS4B	B Grigio titanio GZ8T	B Oliva LV5T	B Cadaques CQ3Q	B Giallo zafferano GZ8A
B Albicocca AB3C	B Orchidea OR7L	B Blu Egeo EG4L			

Caratteristiche Characteristics

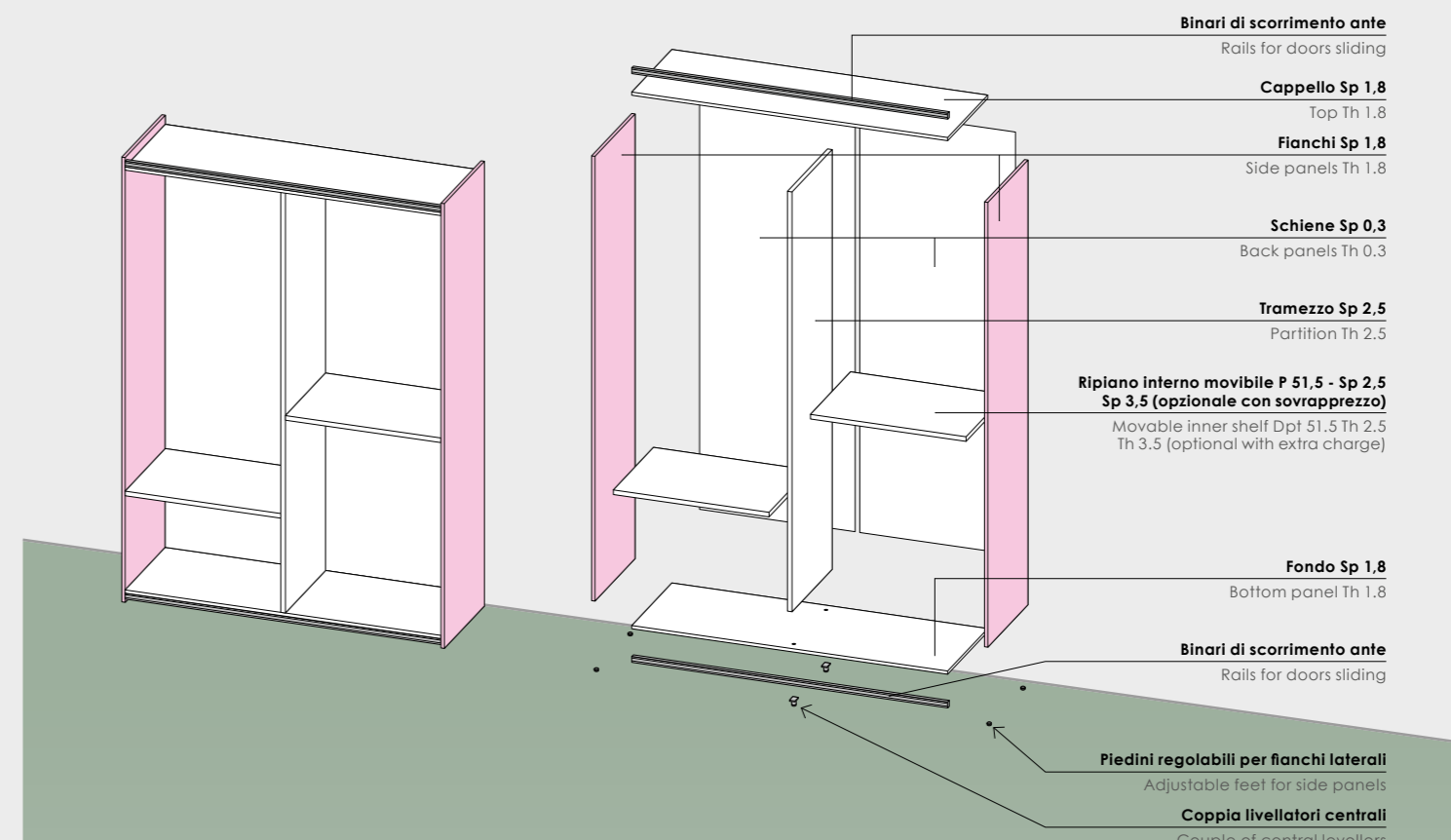

Importante:

- Fianco centrale, cappello, fondo, ripiani e schiena in finitura **Rovere white (RW3Q)**.
- Sono strutture posizionabili solo a terra.
- Sono dotate di piedini regolabili.
- I fianchi sono predisposti per il montaggio della ferramenta dei ripiani.

Dotazione interna

- Sono dotate di 2 tubi appendiabiti e 1 ripiano per ogni vano.

Important:

- Middle panel, top, bottom panel, shelves and back panel in **Rovere white (RW3Q)** finish.
- These structures can only be positioned on the ground.
- Equipped with adjustable feet.
- Side panels are prefitted to take the hardware of shelves.

Element equipment

- Fitted with 2 clothes hanging bars and 1 shelf for each door space.

Nota bene:
Per il montaggio occorre considerare uno spazio aggiuntivo in larghezza di 4 cm e in altezza di 8 cm (per il corretto scorrimento delle ante in nicchia servono almeno 4 cm in altezza).

Please note:
For assembly, at least an extra 4 cm in width and at least an extra 8 cm in height is required (for the correct sliding of the doors in the niche you need at least 4 cm in height).

Utilizzata per:
ARMADI
L 178,7 - 267,5
P 61,5
H 225,3 - 257,3 (piedini H 0,3 compresi)

Used for:
WARDROBES
W 178,7 - 267,5
Dpt 61,5
Ht 225,3 - 257,3 (Ht 0,3 feet included)

Schema di apertura ante scorrevoli

Opening diagram for wardrobes sliding doors

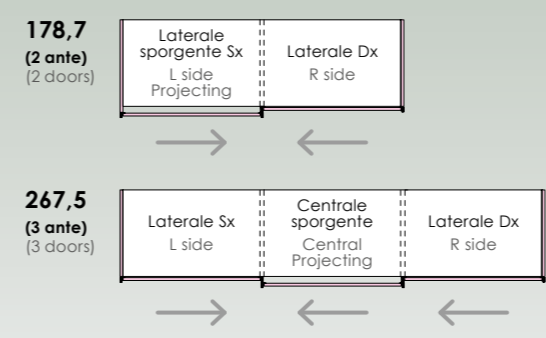

Indicare ante sporgente Dx o Sx

Indicate whether projecting door is R or L

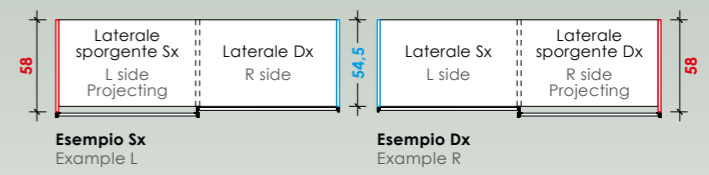

Al momento dell'ordine di armadi a 2 ante, è indispensabile specificare se l'ante sporgente è Dx o Sx. Il fianco accanto all'ante sporgente è profondo 58 cm, mentre il fianco accanto all'ante non sporgente è profondo 54,5 cm.

When ordering wardrobes with 2 doors, it is essential to specify whether the projecting door is R or L. The side panel next to the projecting door has depth 58 cm, while the side panel next to the non-projecting door is 54.5 cm deep.

Non è possibile invertire il verso di apertura.
Door opening direction cannot be reversed.

A Finiture in fascia di prezzo A
Finishes in price range A
B Finiture in fascia di prezzo B
Finishes in price range B
☆ Finiture con effetto materico
Finishes with textured effect

Strutture ad elementi per Componibili a terra/in appoggio

Element structures for floor/support Modular units

Rovere white

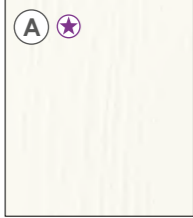

Rovere white
RW3Q

Finitura unica per tutti i componenti in pannello presenti a listino non evidenziati con il colore Finiture GRUPPO 1 e/o Finiture GRUPPO 2.

Unique finish for all the panel components shown in the pricelist not highlighted with the color finishes GROUP 1 and/or finishes GROUP 2.

Finiture GRUPPO 1
GROUP 1 finishes

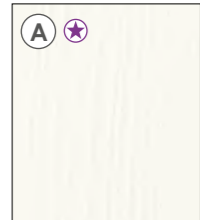

Rovere white
RW3Q

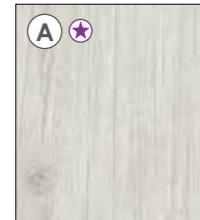

Rovere gesso
RG9L

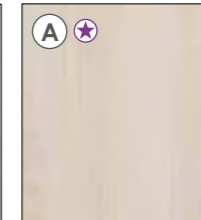

Ciliegio bianco
CB6K

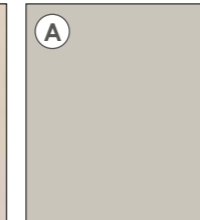

Grigio Dorian
GL4R

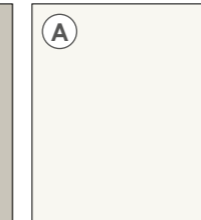

Bianco opaco
BI7A

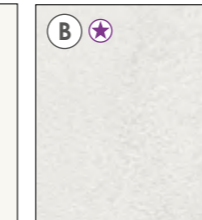

Cemento artico
CA7A

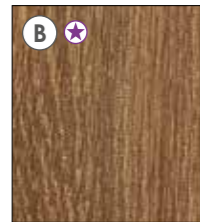

Rovere cognac
RC3Q



Royal oak
RS4B

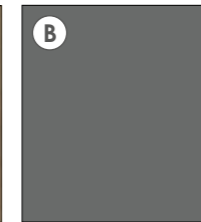

Grigio titanio
GZ8T

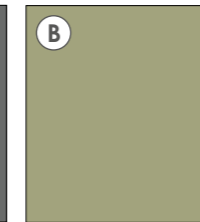

Oliva
LV5T

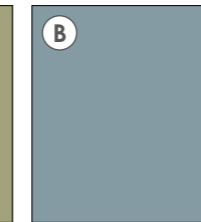

Cadaques
CQ3Q

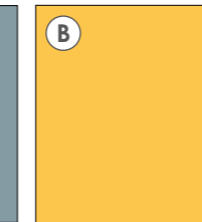

Giallo zafferano
GZ8A

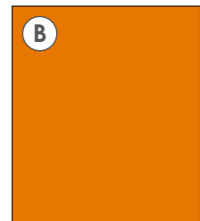

Albicocca
AB3C

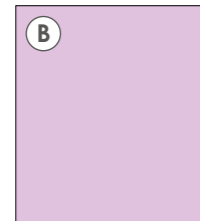

Orchidea
OR7L

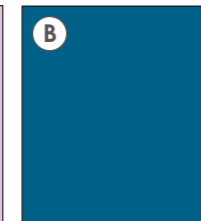

Blu Egeo
EG4L

Caratteristiche

Characteristics

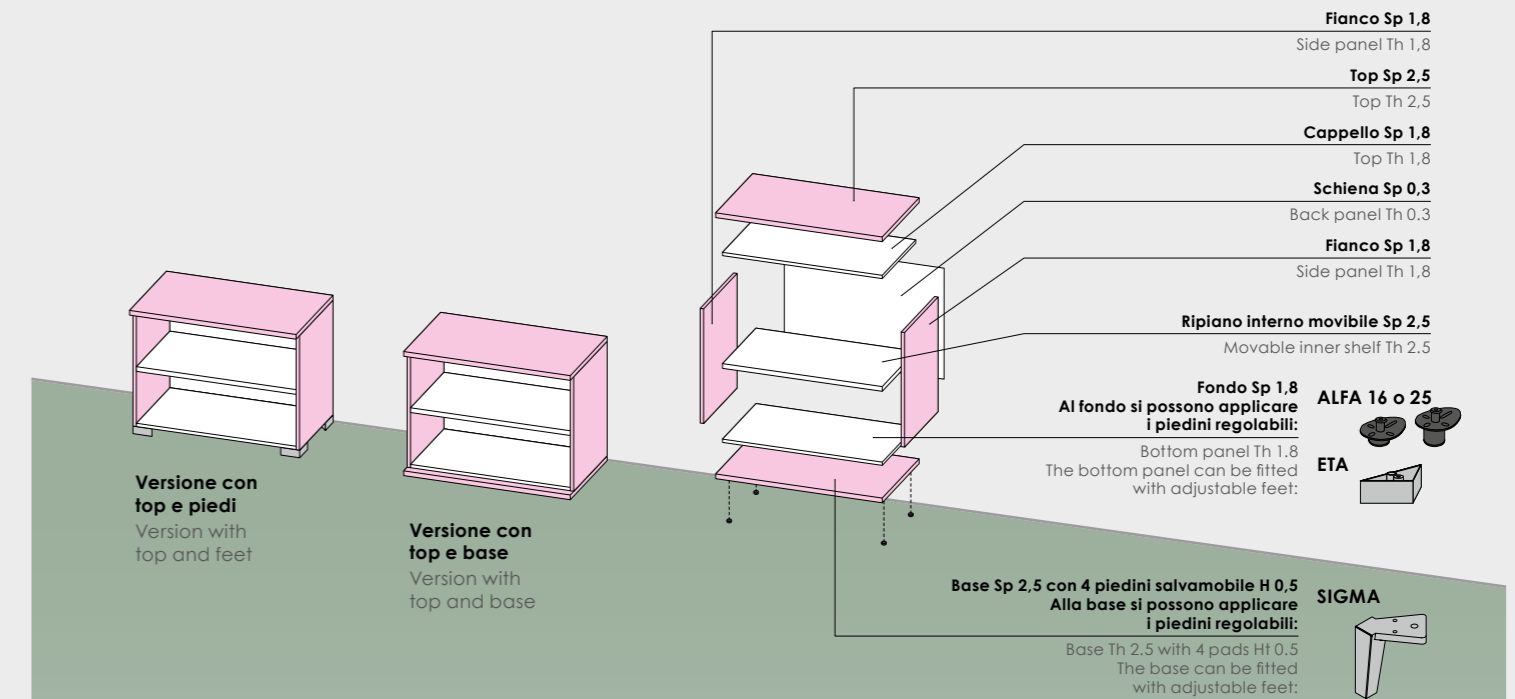

Importante:

- Cappello, fondo, ripiani e schiena in finitura Rovere white (RW3Q).
- Sono strutture posizionabili a terra con l'utilizzo di piedi oppure di una base Sp 2,5 dotata di piedini "salva-mobili" H 0,5.
- Ogni struttura è completa di 2 fianchi perfettamente a filo di cappello e fondo.
- Le strutture possono essere posizionate l'una sull'altra e completate con un top. Composizioni di più elementi possono avere il top e la base interi (L 360 max).
- I fianchi sono predisposti per il montaggio della ferramenta di ante, cassetti e ripiani.
- Vengono forniti montati.

Dotazione interna:

- Tutti gli elementi sono dotati di ripiani interni ogni 32 cm.

Utilizzata per:

COMPONIBILI

L 45 - 60 - 90
P 45,8
H 32 - 64 - 96 - 128 (esclusi top, base, piedi)

Important:

- Top, bottom panel, shelves and back panel in Rovere white (RW3Q) finish.
- These structures can be positioned on the floor with use feet or base Th 2,5 with feet "save-furniture" Ht 0,5.
- Each structure is complete with 2 sides which finish flush with top and bottom.
- Structures can be positioned one on top of the other and completed with top. A composition of multiple units can share same top and bottom (W 360 max).
- Side panels are prefitted to take the hardware of doors, drawers and shelves
- Elements are supplied assembled.

Internal equipment:

- All items come with inner shelves every 32 cm.

Used for:

MODULAR UNITS
W 45 - 60 - 90
Dpt 45,8
Ht 32 - 64 - 96 - 128 (top, base and feet not included)

Esempi di componibilità

Examples of compositions

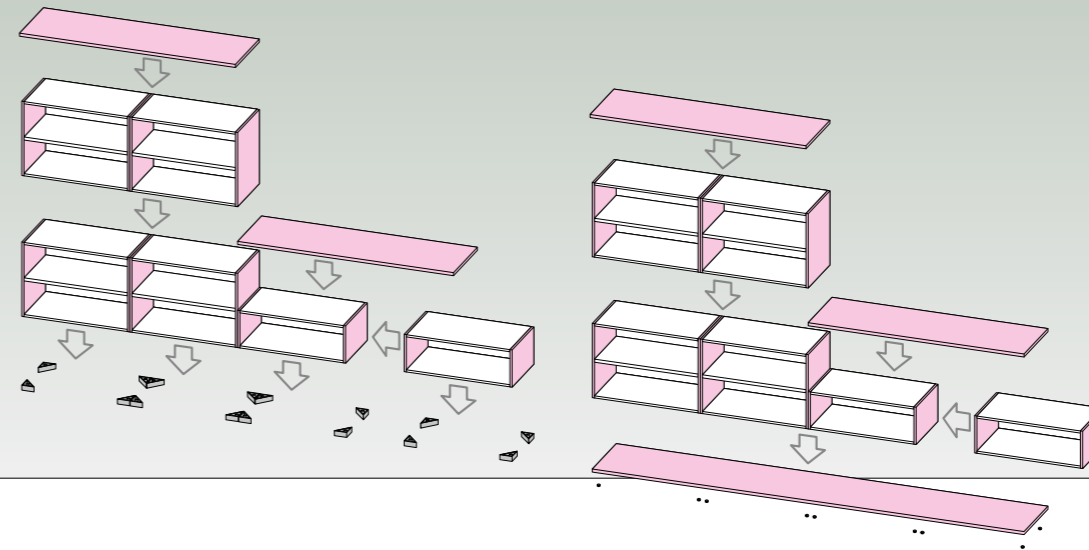

- A** Finiture in fascia di prezzo A
Finishes in price range A
- B** Finiture in fascia di prezzo B
Finishes in price range B
- ☆** Finiture con effetto materico
Finishes with textured effect

Strutture ad elementi per Componibili sospesi e Pensili e Pensili

Element structures for Suspended modular units and Hanging units

Rovere white

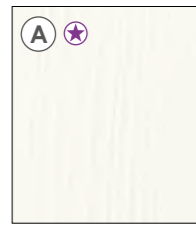

Rovere white
RW3Q

Finitura unica per tutti i componenti in pannello presenti a listino non evidenziati con il colore Finiture GRUPPO 1 e/o Finiture GRUPPO 2.

Unique finish for all the panel components shown in the pricelist not highlighted with the color finishes GROUP 1 and/or finishes GROUP 2.

Finiture GRUPPO 1
GROUP 1 finishes

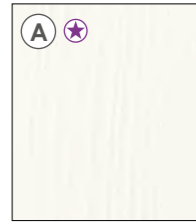

Rovere white
RW3Q

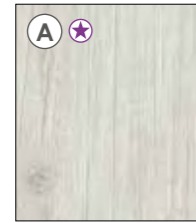

Rovere gesso
RG9L

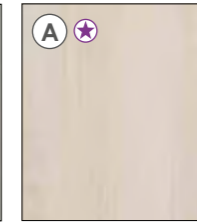

Ciliegio bianco
CB6K

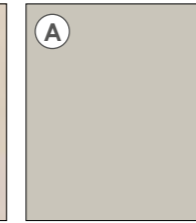

Grigio Dorian
GL4R



Bianco opaco
BI7A

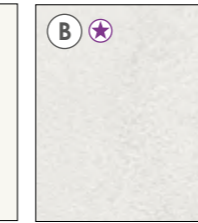

Cemento artico
CA7A

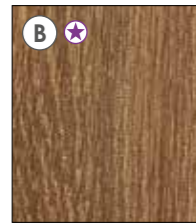

Rovere cognac
RC3Q



Royal oak
RS4B

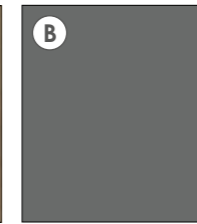

Grigio titanio
GZ8T

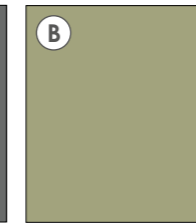

Oliva
LV5T

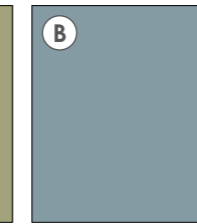

Cadaques
CQ3Q

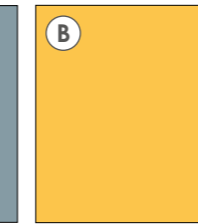

Giallo zafferano
GZ8A

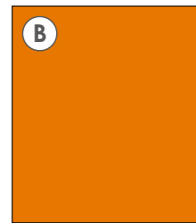

Albicocca
AB3C

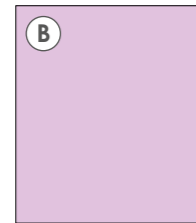

Orchidea
OR7L

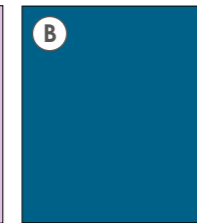

Blu Egeo
EG4L

- A** Finiture in fascia di prezzo A
Finishes in price range A
- B** Finiture in fascia di prezzo B
Finishes in price range B
- ☆ Finiture con effetto materico
Finishes with textured effect

Caratteristiche Characteristics

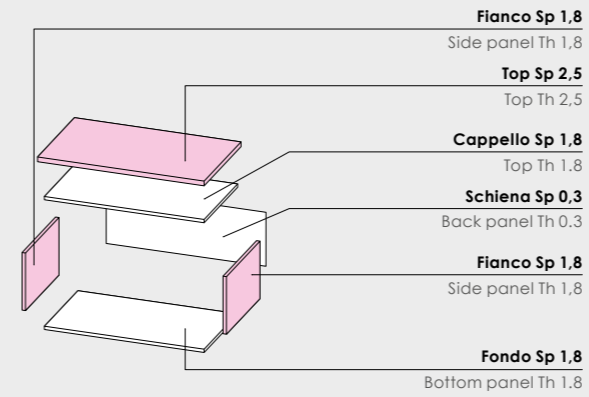

COMPONIBILE SOSPESO
SUSPENDED MODULAR UNIT

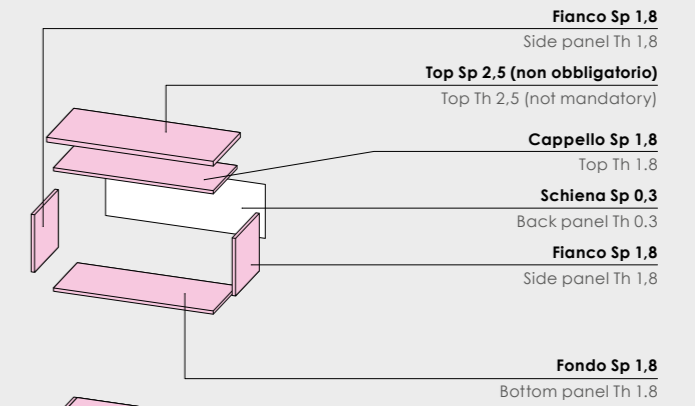

PENSILE
HANGING UNIT

Importante:

- Componibili sospesi con cappello, fondo, ripiani e schiena in finitura **Rovere white (RW3Q)**.
- Pensili con ripiani e schiena in finitura **Rovere white (RW3Q)**.
- Ogni struttura è completa di 2 fianchi perfettamente a filo di cappello e fondo.
- I fianchi sono predisposti per il montaggio della ferramenta delle ante.
- Completare ogni composizione di Componibili sospesi con top. Nei Pensili l'utilizzo del top non è obbligatorio.
- Composizioni di più elementi possono avere il top intero (L 360 max).
- I Componibili sospesi ed i Pensili sono completi di attaccaglie per fissaggio al muro dotate di antisganciamento. Nei Pensili la ferramenta è di tipo invisibile.
- Vengono forniti montati.
- Rispondono alla normativa europea 14749 "Requisiti di sicurezza dei mobili contenitori per uso domestico".

Dotazione interna:

- Tutti gli elementi sono dotati di ripiani interni ogni 32 cm.

Utilizzata per:

COMPONIBILI SOSPESI

L 45 - 60 - 90
P 45,8
H 32 - 64 (escluso top)

PENSILI

L 45 - 60 - 90 H 32
L 30 - 45 - 60 H 96 - 128
L 30 - 45 H 160
P 32,5

Importante:

- Suspended modular units with top, bottom panel, shelves and back panel in **Rovere white (RW3Q)** finish.
- Hanging units with shelves and back panel in **Rovere white (RW3Q)** finish.
- Each structure is complete with 2 sides which finish flush with top and bottom.
- Side panels are pre-fitted to take the hardware of doors.
- Complete every suspended Modular composition with top. The top on the hanging units is not essential. Multiple element compositions can share same top (W 360 max).
- The suspended modular units and hanging units come with adjustable brackets with an antirelease device for wall fixing. The hardware in the wall units is invisible type.
- Elements are supplied assembled.
- They comply with the European standard 14749 "Safety requirements for storage furniture for domestic use".

Internal equipment:

- All items come with inner shelves every 32 cm.

Used for:

SUSPENDED MODULAR UNITS

W 45 - 60 - 90
Dpt 45,8
Ht 32 - 64 (top excluded)

HANGING UNITS

W 45 - 60 - 90 Ht 32
W 30 - 45 - 60 Ht 96 - 128
W 30 - 45 Ht 160
Dpt 32,5

Finiture GRUPPO 1
GROUP 1 finishes

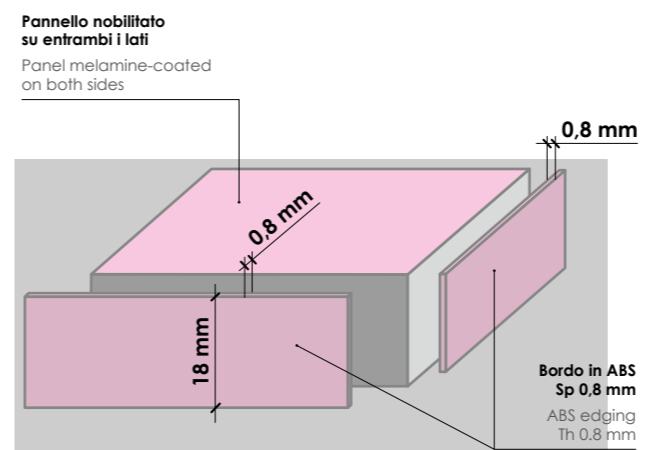

Dimensioni disponibili
Dimensions available

- Ante**
- Possono essere applicate tutte le maniglie di serie.
 - Sono fornite con preforo.
 - Riducibili in altezza e in larghezza.
 - **Su richiesta possono essere dotate di rallentatori di chiusura (con sovrapprezzo).**
- Doors**
- Can be fitted with all standard handles.
 - Supplied with semi-cut hole.
 - Can be reduced in height and width.
 - **Can be fitted with closing retainers on request (with surcharge).**

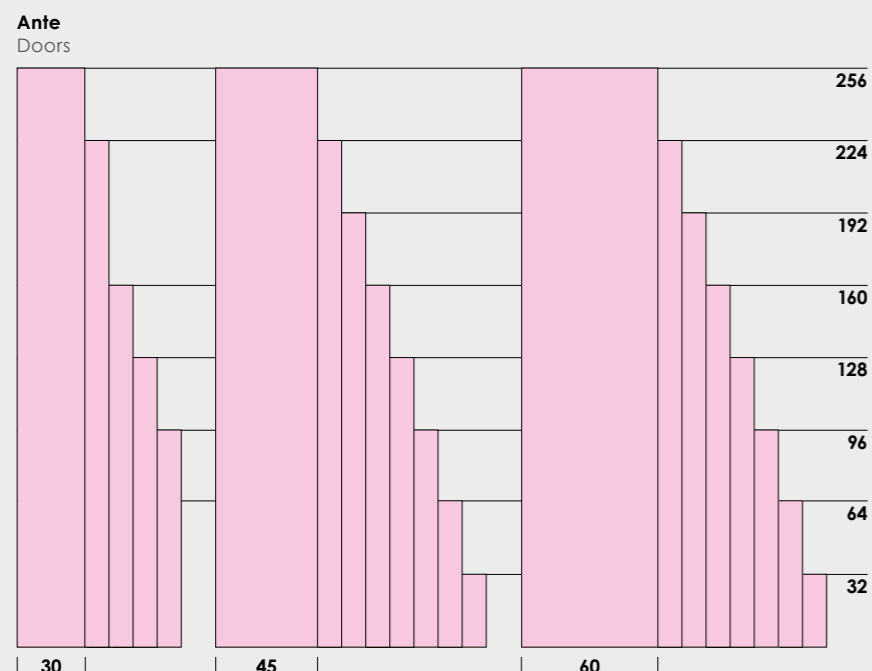

- Ante specchio**
- Specchio Sp 4 mm applicato su pannello in nobilitato Sp 1,8.
 - Sono dotate di pomello SEM.
 - Non sono riducibili in altezza e in larghezza.
 - **Su richiesta possono essere dotate di rallentatori di chiusura (con sovrapprezzo).**
- Mirror doors**
- Mirror Th 4 mm applied on melamine-coated panel Th 1.8.
 - Equipped with SEM knob.
 - Cannot be reduced in height and width.
 - **Can be fitted with closing retainers on request (with surcharge).**

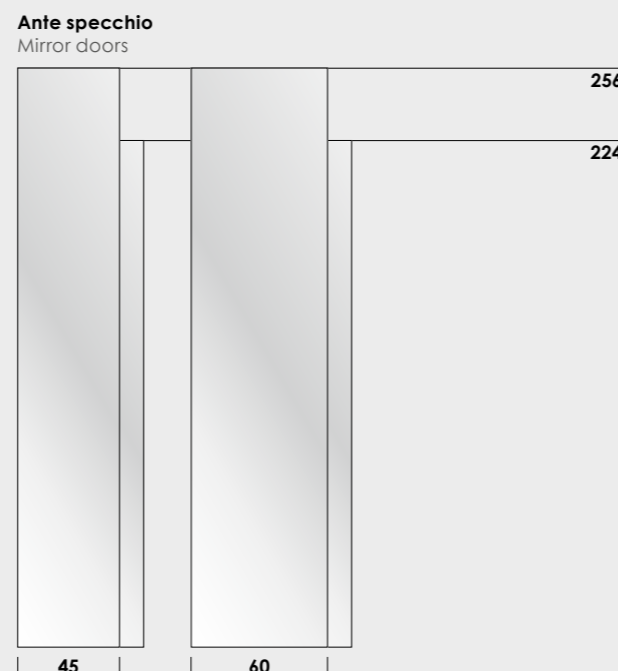

- Cassetti/cassettoni**
- Interno cassetto in finitura Rovere white (RW3Q).
 - Possono essere applicate tutte le maniglie di serie.
 - Sono forniti con preforo.
 - Guide scorrevoli metalliche regolabili in altezza.
 - Non riducibili in altezza e in larghezza.
 - **Su richiesta possono essere dotati di rallentatori di chiusura (con sovrapprezzo).**
- Drawers/big drawers**
- Drawer interior in Rovere white (RW3Q) finish.
 - Can be fitted with all standard handles.
 - Supplied with semi-cut hole.
 - Sliding metal runners adjustable in height.
 - Cannot be reduced in height and width.
 - **Can be fitted with closing retainers on request (with surcharge).**

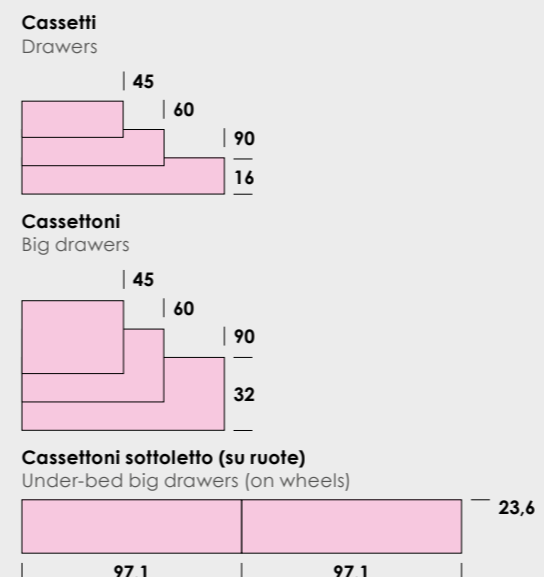

- Ante vasistas/ribalta**
- Possono essere applicate tutte le maniglie di serie.
 - Sono fornite con preforo.
 - Solo per Componibili e Pensili.
 - Non riducibili in altezza e larghezza.
- Lift up/pull-down doors**
- Can be fitted with all standard handles.
 - Supplied with pre-cut hole.
 - For Modular units and Wall units only.
 - Cannot be reduced in height and width.

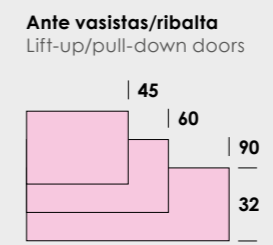

A Finiture in fascia di prezzo A
Finishes in price range A

B Finiture in fascia di prezzo B
Finishes in price range B

☆ Finiture con effetto materico
Finishes with textured effect

pag. 40 Posizionamento pomelli e maniglie
Knobs and handles position

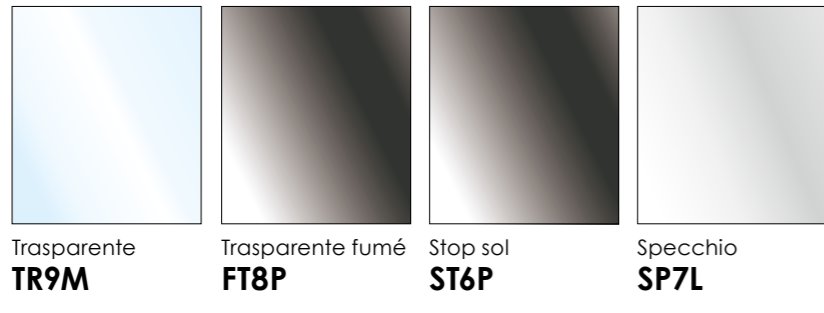

Colori telaio:
Frame colours:

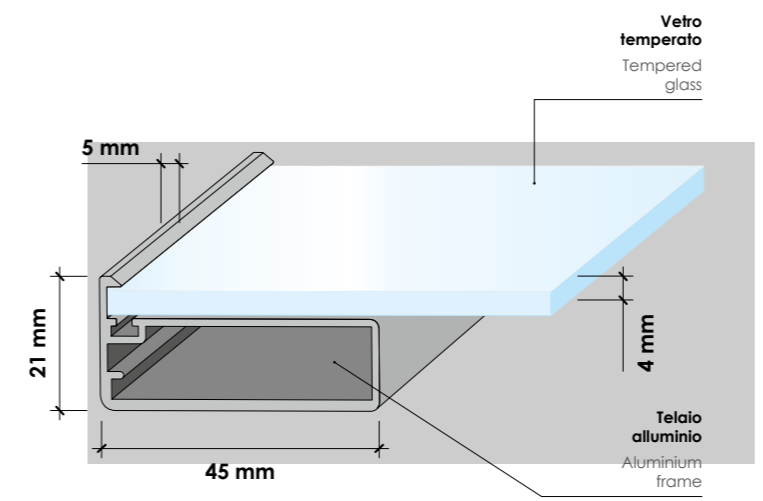

Vetri
Glass

Dimensioni disponibili
Dimensions available

- Ante**
- Dotate di maniglia in tinta integrata nel telaio sempre posizionata a metà altezza dell'anta, escluse le ante H 224 e 256 nelle quali la maniglia è ad H 102 da terra.
 - La maniglia dell'anta WINDOW non si allinea con quelle dell'anta in nobilitato.
 - Non possono essere dotate di serratura.
 - Non possono essere modificate in altezza e larghezza.
 - Su richiesta possono essere dotate di rallentatori di chiusura (con sovrapprezzo).
- Doors**
- These are fitted with handles integrated in the frame always placed halfway up the door, except for doors Ht 224 and 256 where the handle is at Ht 102 from the ground.
 - The handle of the WINDOW door is not in line with the handle of the laminated door.
 - They cannot be fitted with a lock.
 - These items' height and width cannot be altered.
 - Can be fitted with closing retainers on request (with surcharge).

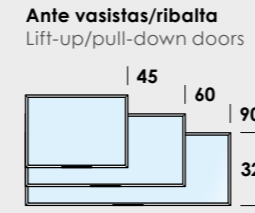
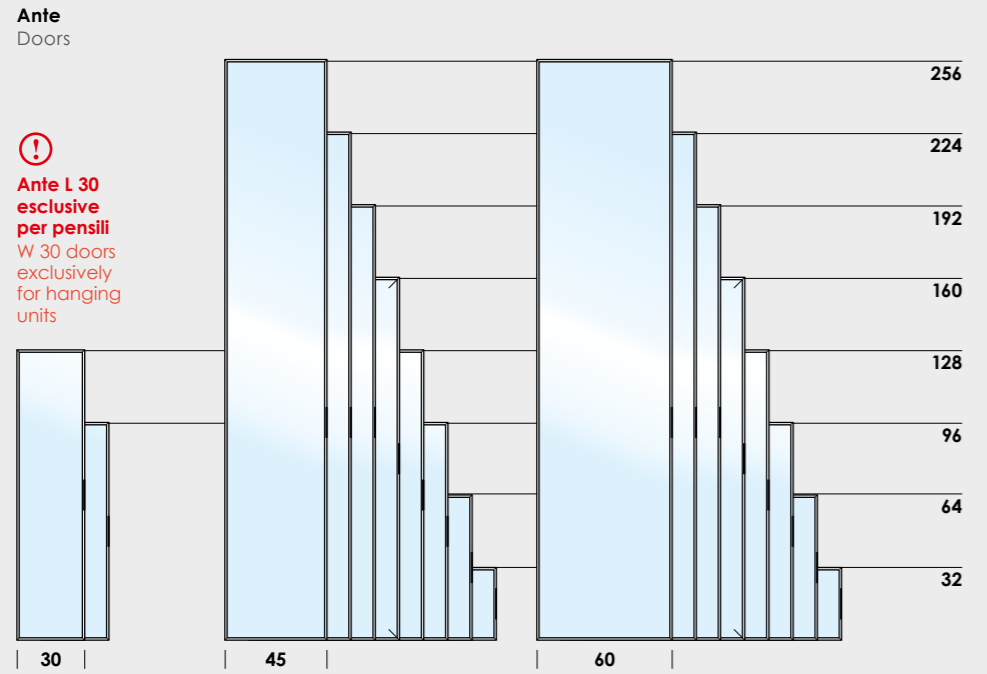

Consigliamo di non posizionare le ante WINDOW nella maniera indicata perché la maniglia potrebbe risultare troppo in alto.
We recommend against positioning WINDOW doors as shown because the handle might be too high up

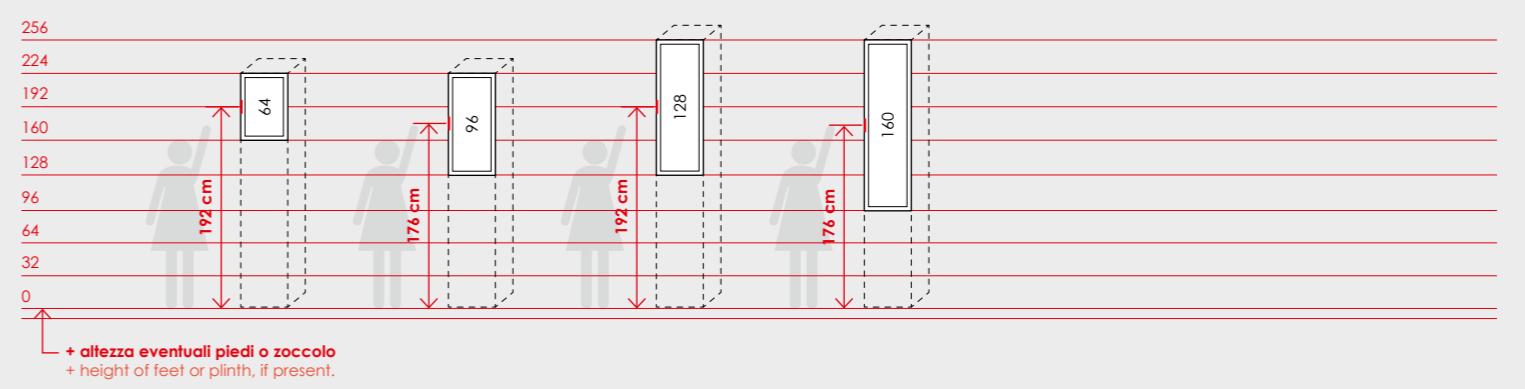

Ante scorrevoli

Sliding doors

Finiture GRUPPO 1
GROUP 1 finishes

 (A) ☆	 (A) ☆	 (A) ☆	 (A)	 (A)	 (B) ☆
Rovere white RW3Q	Rovere gesso RG9L	Ciliegio bianco CB6K	Grigio Dorian GL4R	Bianco opaco BI7A	Cemento artico CA7A
 (B) ☆	 (B) ☆	 (B)	 (B)	 (B)	 (B)
Rovere cognac RC3Q	Royal oak RS4B	Grigio titanio GZ8T	Oliva LV5T	Cadaques CQ3Q	Giallo zafferano GZ8A
 (B)	 (B)	 (B)	 (A)	Il pannello sul quale viene applicato lo specchio è sempre colore Bianco opaco (BI7A) The panel on which the mirror is applied is always Bianco opaco (BI7A)	
Albicocca AB3C	Orchidea OR7L	Blu Egeo EG4L	Specchio SP7L		

Profilo maniglia ante scorrevoli



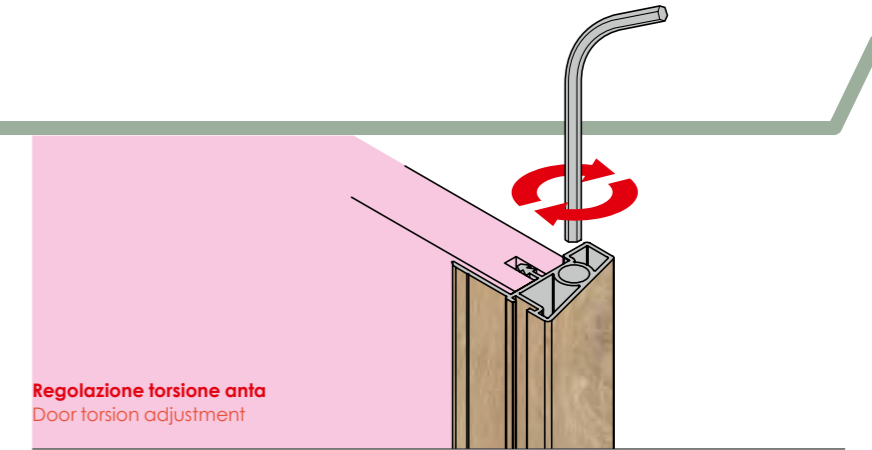
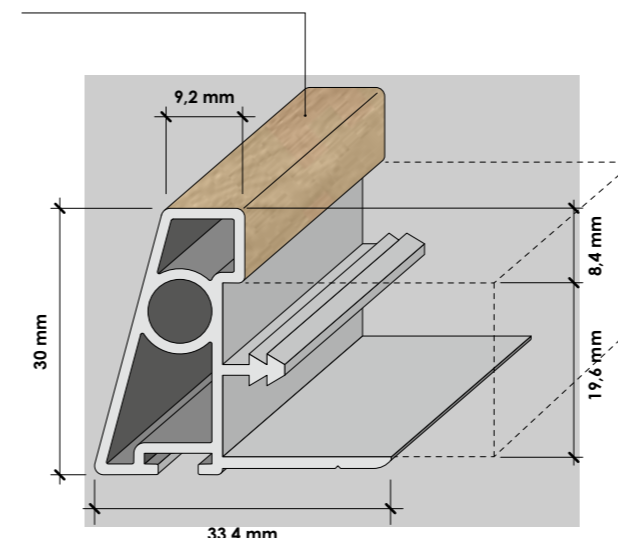

Sliding doors handle groove strip

Profilo verticale in alluminio
Aluminium vertical trim

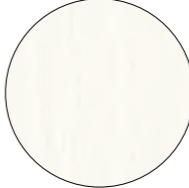

Regolazione torsione anta
Door torsion adjustment

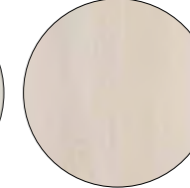
Colori profili maniglia:
Handle groove strip colours:

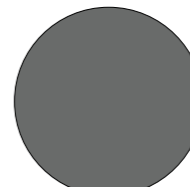
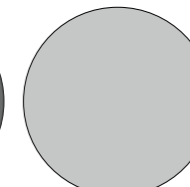
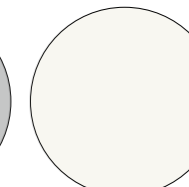
			
Rovere white RW3Q	Rovere gesso RG9L	Ciliegio bianco CB6K	Rovere cognac RC3Q
			
Royal oak RS4B	Grigio titanio GZ8T	Alluminio AL1A	Bianco opaco BI7A

Dimensioni disponibili

Dimensions available

- Ante scorrevoli**
- Non possono essere modificate in altezza e larghezza.
 - Su richiesta possono essere dotate di sistema frenante (apertura/chiusura ante) (con sovrapprezzo).
- Sliding doors
- They cannot be modified in height and width.
 - On request can be equipped with braking system (opening/closing doors) (with surcharge).

Ante scorrevoli

Sliding doors

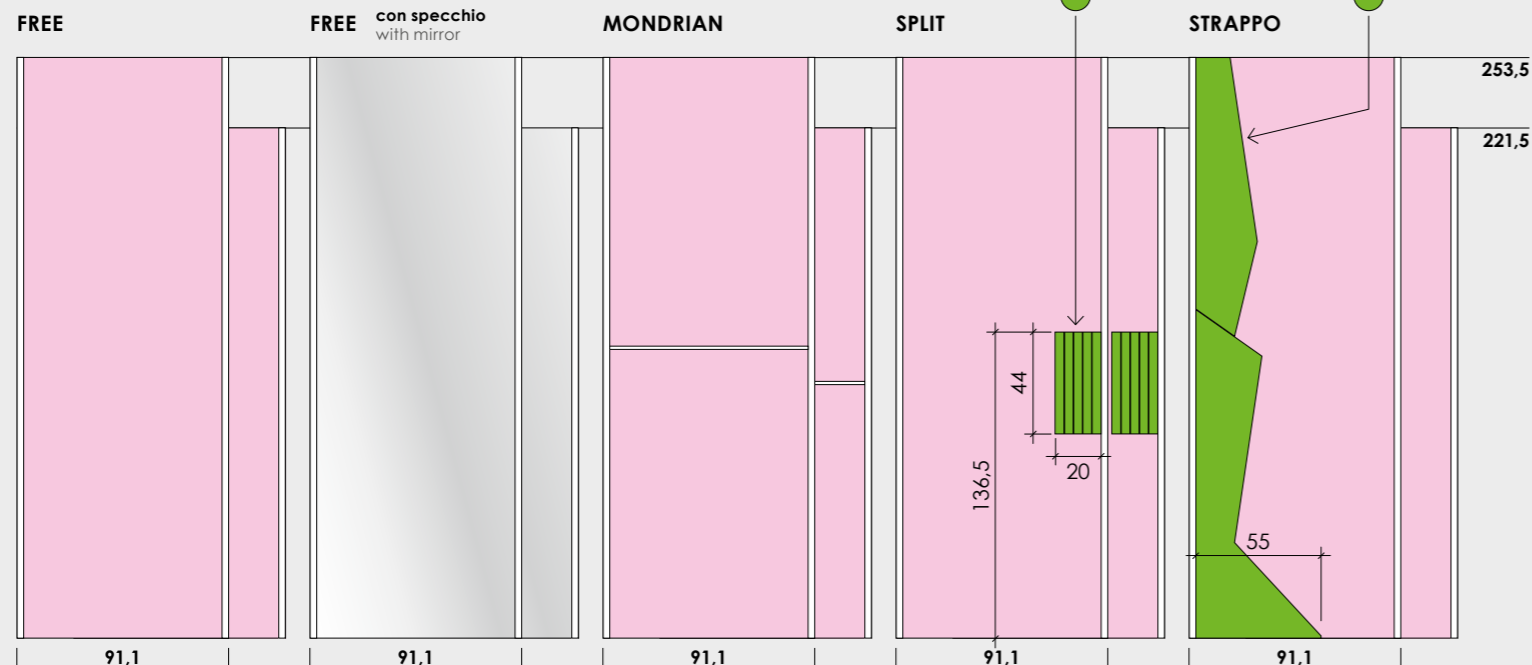

Caratteristiche specifiche delle ante scorrevoli

Specific characteristics of sliding doors

FREE con specchio
with mirror
Specchio Sp 4 mm applicato su pannello in nobilitato Sp 1.4.
Mirror Th 4 mm applied on melamine-coated panel Th 1.4.

MONDRIAN
È possibile personalizzare le facciate dell'armadio specificando i colori desiderati per ogni quadrotto. Per il corretto posizionamento dei quadrotti è indispensabile inviare un disegno dell'armadio.
Wardrobe fronts can be customised by specifying the colours required for each squared panel. For correct positioning of the squared panels, it is essential to send a drawing of the wardrobe.

SPLIT
Le ante sono dotate di un riparto laccato, in pannello di MDF Sp 0,4, applicato in posizione prestabilita (vedi soluzioni proposte).
The doors are equipped with a lacquered MDF insert panel Th 0,4 applied in a pre-established position (see proposed solutions).

STRAPPO
L'anta laterale Dx dell'armadio ha un riparto laccato, in pannello di MDF Sp 0,4, applicato in posizione prestabilita (vedi soluzioni proposte). N.B. Il colore scelto per il riparto STRAPPO determinerà automaticamente anche la finitura delle ante scorrevoli sprovviste di riparto.
The R side door of the wardrobe has a lacquered MDF insert panel Th 0.4 applied in a pre-established position (see proposed solutions). N.B. The colour chosen for the STRAPPO insert panel will automatically determine the finish for the sliding doors without the insert panel.

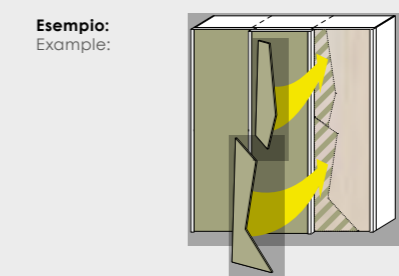
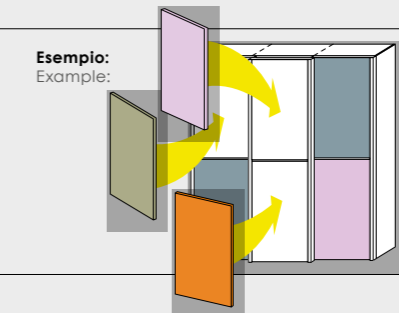

Schema di apertura ante scorrevoli

Opening diagram for sliding doors

178,7 (2 ante)
(2 doors)

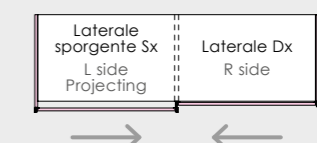

267,5 (3 ante)
(3 doors)

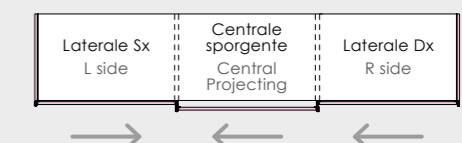

Non è possibile invertire il verso di apertura.
The opening direction cannot be inverted.

- (A) Finiture in fascia di prezzo A
Finishes in price range A
- (B) Finiture in fascia di prezzo B
Finishes in price range B
- (☆) Finiture con effetto materico
Finishes with textured effect



⚠ Si eseguono tagli a misura solo se richiesti con disegno esplicativo.
Customized cuts can be made only if you provide an explanatory drawing.

				
		RIDUZIONE IN LARGHEZZA REDUCED WIDTH	RIDUZIONE IN ALTEZZA REDUCED HEIGHT	RIDUZIONE IN PROFONDITÀ REDUCED DEPTH
Cassetti e cassette	Drawers and big drawers	X	X	X
Ante battenti VOLO	VOLO hinged doors	V	V	-
Ante battenti VOLO con specchio	VOLO hinged doors with mirror	X	X	-
Ante battenti WINDOW	WINDOW hinged doors	X	X	-
Ante vasistas e ribalta	Lift-up and pull-down doors	X	X	-
Ante scorrevoli	Sliding doors	X	X	-
Armadi con ante battenti	Wardrobes with hinged doors	V	V	V
Armadio porta tv	Tv wardrobes	X	V	V
Angoli interi, Cabine ad angolo, Terminali	Corner wardrobes, Corner walk-in wardrobes, End units	X	V	X
Librerie terminali ORDER e OLA	ORDER and OLA end bookshelves	X	V	X
Armadi con ante scorrevoli	Wardrobes with sliding doors	X	X	V
Sistema COMBY	COMBY system	X	X	X
Armadi ponte	Overhead wardrobes	V	V	X
Letti a soppalco BRIDGE	BRIDGE loft beds	X	V	X
Letti a castello WINNER, REVOLUTION, TITANO	WINNER, REVOLUTION, TITANO equipped bunk bed	X	X	X
Letti e turche non attrezzati	Not equipped beds and ottomans	X	X	V
Letti e turche attrezzati, divani letto	Equipped beds and ottomans, sofa beds	X	X	X
Letti imbottiti	Padded beds	X	X	X
Piani sagomati	Shaped worktops	X	X	X
Cubolotti e pannelli attrezzati	Cubes and equipped panels	X	X	X
Librerie INFINITY	INFINITY bookshelves	V	V	X
Angolo intero, Terminale INFINITY	INFINITY Full corner, Shaped end unit	X	V	X
Componibili a terra/in appoggio	Floor/support modular units Dpt 45.8	V	V	X
Componibili sospesi e Pensili	Suspended modular units and Hanging units	X	X	X
Moduli sospesi SNAKE	SNAKE suspended modular units	X	X	X
Tavoli e sedie	Tables and chairs	X	X	X
Elementi in vetro	Glass elements	X	X	-
Parti metalliche	Metal parts	X	X	-

RIDUZIONE IN LARGHEZZA REDUCED WIDTH

ARMADI e COMPONENTI
WARDROBES and MODULAR UNITS



Esempio: per ridurre in larghezza un armadio ad 1 ante si tagliano 5 componenti (fondo, cappello, ripiano, schiena e 1 ante); pertanto il costo di questa lavorazione è di:
Example: to reduce the width of a 1-door wardrobe, 5 components have to be cut (bottom panel, top, shelf, back panel and 1 door); therefore, the cost of this process is:

LIBRERIA INFINITY INFINITY BOOKSHELVES

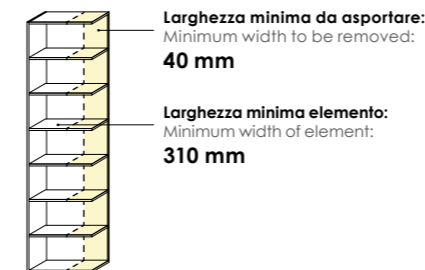

RIDUZIONE IN ALTEZZA REDUCED HEIGHT

ARMADI
WARDROBES

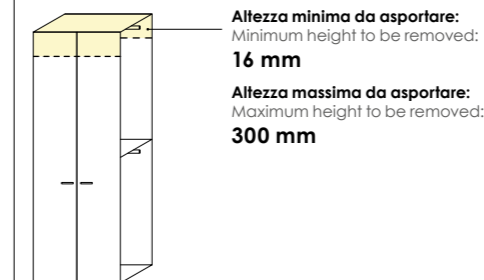

Esempio: per ridurre in altezza un armadio a 2 ante si tagliano 4 componenti (2 ante, schiena e fianco); pertanto il costo di questa lavorazione è di:
Example: to reduce the height of a 2-doors wardrobe, 4 components have to be cut (2 doors, back panel and side panel); therefore, the cost of this process is:

LIBRERIA INFINITY INFINITY BOOKSHELVES

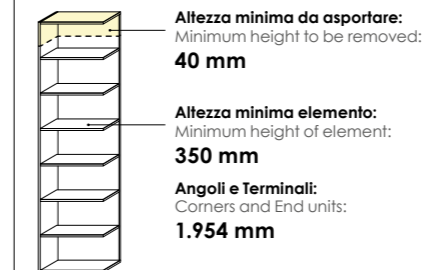

COMPONIBILI MODULAR UNITS

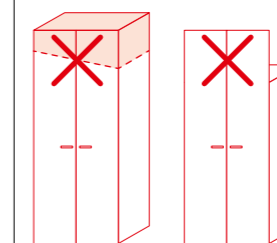
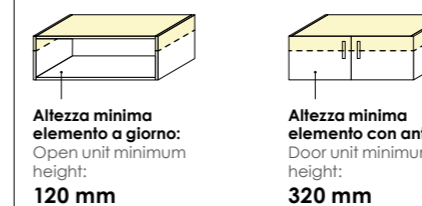

- Si taglia sempre sopra
- NO taglio obliquo
- NO altezza cassa diversa dalle facciate
- It is always cut above
- NO slanted cut
- NO carcasse height different from the fronts

RIDUZIONE IN PROFONDITÀ REDUCED DEPTH

ARMADI
WARDROBES

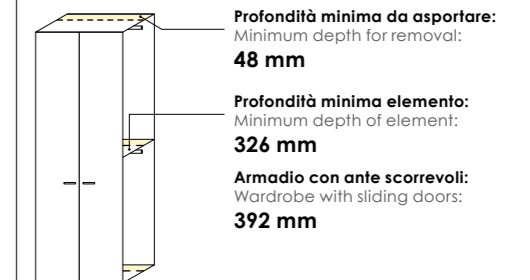

Esempio: per ridurre in profondità un armadio si tagliano 4 componenti (fondo, cappello, ripiano e fianco); pertanto il costo di questa lavorazione è di:
Example: to reduce the depth of a wardrobe, 4 components have to be cut (bottom panel, top panel, shelf and side panel); therefore, the cost of this process is:

ELEMENTO CENTRALE CENTRAL ELEMENT

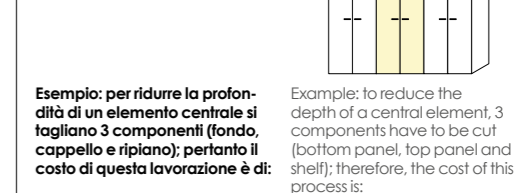

Esempio: per ridurre la profondità di un elemento centrale si tagliano 3 componenti (fondo, cappello e ripiano); pertanto il costo di questa lavorazione è di:
Example: to reduce the depth of a central element, 3 components have to be cut (bottom panel, top panel and shelf); therefore, the cost of this process is:

ELEMENTO FINALE END ELEMENT

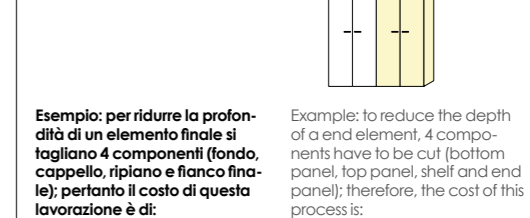

Esempio: per ridurre la profondità di un elemento finale si tagliano 4 componenti (fondo, cappello, ripiano e fianco finale); pertanto il costo di questa lavorazione è di:
Example: to reduce the depth of an end element, 4 components have to be cut (bottom panel, top panel, shelf and end panel); therefore, the cost of this process is:

In caso di armadi ridotti in profondità si consiglia l'utilizzo di tubi appendi abiti scorrevoli.
La libreria INFINITY non si riduce in profondità.
With small depth wardrobes we recommend using sliding clothes rails.
The INFINITY bookshelf can not be reduced in depth.

TOP e MENSOLE TOP and SHELVES

Profondità minima top e mensola:
Minimum depth top and shelves: 
200 mm
Top lineare per scrittoio (perde ogni tipo di foratura)
Linear top for desk (it lose all type of holes)
150 mm
Mensole con reggimensola A SCOMPARSA
Shelves with A SCOMPARSA shelf-holders
100 mm
Top per componibili/pensili (perdono ogni tipo di foratura)
Mensole senza reggimensola
Mensole con reggimensola LAMPO e KUB
Top for modular units/hanging units (they lose all type of holes)
Shelves without shelf-holders
Shelves with LAMPO and KUB shelf-holders

Facciate Fronts
VOLO

Finiture GRUPPO 1
GROUP 1 finishes

Finiture GRUPPO 2
GROUP 2 finishes

Rovere white*

(A) ☆	(A) ☆	(A) ☆	(A)	(B) ☆	(B) ☆
Rovere white RW3Q	Rovere gesso RG9L	Ciliegio bianco CB6K	Grigio Dorian GL4R	Cemento antico CA7A	Rovere cognac RC3Q
(B) ☆	(B)	(B)	(B)		
Royal oak RS4B	Grigio titanio GZ8T	Oliva LV5T	Cadaques CQ3Q		
(A)	(B)	(B)	(B)	(B)	
Bianco opaco B17A	Giallo zafferano GZ8A	Albicocca AB3C	Orchidea OR7L	Blu Egeo EG4L	

Vetri Glass

Ante Doors
WINDOW

Colori telaio
Frame colours

Trasparente TR9M	Trasparente fumé FT8P	Stop sol ST6P	Specchio SP7L	Alluminio AL1A	Titan grey TG7H

Rovere white* Finitura unica per tutti i componenti in pannello presenti a listino non evidenziati con il colore Finiture GRUPPO 1 e/o Finiture GRUPPO 2.
Unique finish for all the panel components shown in the pricelist not highlighted with the color finishes GROUP 1 and/or finishes GROUP 2.

- A** Finiture in fascia di prezzo A
Finishes in price range A
- B** Finiture in fascia di prezzo B
Finishes in price range B
- ☆ Finiture con effetto materico
Finishes with textured effect

MANIGLIE, ACCESSORI, SEDIE E TAVOLI
HANDLES, ACCESSORIES, CHAIRS AND TABLES

Pomelli e maniglie Knobs and handles	pag. 34
Posizionamento pomelli e maniglie Knobs and handles position	pag. 40
Ferramenta Hardware	pag. 42
Campionari e vernici Colour sample sets and paints	pag. 44
Pannelli e bordi Panels and edged	pag. 44
Illuminazione Lighting	pag. 45
Appendiabiti Clothes hook	pag. 45
Sedie Chairs	pag. 46
Tavoli DALLAS DALLAS tables	pag. 47
Ante Doors	pag. 48
Cassetti e cassettoni VOLO VOLO drawers and big drawers	pag. 51
Pannello anta VOLO senza fori cerniera e maniglia VOLO door panel without hinge and handle holes	pag. 52



FOL



L W mm	Passo Span mm	COD.	Sovrapprezzo Surcharge	COD.	Sfusa Loose
35	-	T01A	-	VF30.00S	

H Ht mm	35	Sporgenza Projection mm	26
---------------	----	-------------------------------	----

P11

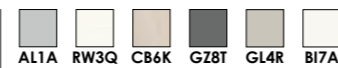

L W mm	Passo Span mm	COD.	Sovrapprezzo Surcharge	COD.	Sfusa Loose
21	-	G01M	-	VF30.01Y	

H Ht mm	21	Sporgenza Projection mm	20
---------------	----	-------------------------------	----

SEM



L W mm	Passo Span mm	COD.	Sovrapprezzo Surcharge	COD.	Sfusa Loose
20	-	H07L	-	VF29.99L	

H Ht mm	20	Sporgenza Projection mm	24
---------------	----	-------------------------------	----

BING



! Può essere montata ruotata di 90°
It can be mounted rotated 90°



L W mm	Passo Span mm	COD.	Sovrapprezzo Surcharge	COD.	Sfusa Loose
100	32	E74N		VF30.02E	

H Ht mm	140	Sporgenza Projection mm	25
---------------	-----	-------------------------------	----

Maniglie con foratura VERTICALE
Handles with VERTICAL drilling
Maniglie con foratura ORIZZONTALE
Handles with HORIZONTAL drilling

AB3C Albicocca
AL1A Alluminio
AS7H Alluminio spazzolato
BI7A Bianco opaco
CB6K Ciliegio bianco
CQ3Q Cadaques
CS4B Champagne spazzolato
EG4L Blu Egeo
GL4R Grigio Dorian
GZ8A Giallo zafferano
GZ8T Grigio titanio
LV5T Oliva
NS3Q Nero spazzolato
OR7L Orchidea
RC3Q Rovere cognac
RG9L Rovere gesso
RS4B Royal oak
RW3Q Rovere white

DROP



! Può essere montata ruotata di 90°
It can be mounted rotated 90°



L W mm	Passo Span mm	COD.	Sovrapprezzo Surcharge	COD.	Sfusa Loose
86	32	E73K		VF30.03M	

H Ht mm	140	Sporgenza Projection mm	25
---------------	-----	-------------------------------	----

MASK



L W mm	Passo Span mm	COD.	Sovrapprezzo Surcharge	COD.	Sfusa Loose
100	32	E72F		VF30.04T	

H Ht mm	80	Sporgenza Projection mm	25
---------------	----	-------------------------------	----

BEN



L W mm	Passo Span mm	COD.	COD.	Sovrapprezzo Surcharge	COD.	Sfusa Loose
132	96	E34P	E13F	-	VF30.05Z	

H Ht mm	26	Sporgenza Projection mm	22
---------------	----	-------------------------------	----

VER

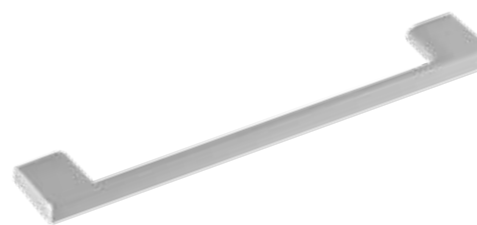

L W mm	Passo Span mm	COD.	COD.	Sovrapprezzo Surcharge	COD.	Sfusa Loose
113	96	E33K	E31Y		VF30.06F	
186	160	E36R	T07C		VF30.07N	

H Ht mm	9	Sporgenza Projection mm	28
---------------	---	-------------------------------	----



BIS

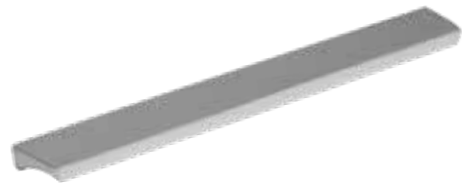

L W mm	Passo Span mm	COD.	COD.	Sovrapprezzo Surcharge	COD.	Sfusa Loose
192	160	T03C	G35F	-	VF30.08U	

H Ht mm	9	Sporgenza Projection mm	20
---------------	---	-------------------------------	----

DER



L W mm	Passo Span mm	COD.	COD.	Sovrapprezzo Surcharge	COD.	Sfusa Loose
190	160	T05M	T02K		VF30.09A	

H Ht mm	35	Sporgenza Projection mm	24
---------------	----	-------------------------------	----

GAB

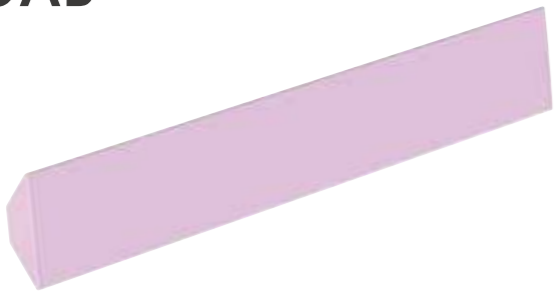

L W mm	Passo Span mm	COD.	COD.	Sovrapprezzo Surcharge	COD.	Sfusa Loose
304	160	E16C	E15A		VF30.10X	

H Ht mm	46	Sporgenza Projection mm	18
---------------	----	-------------------------------	----

LIG



L W mm	Passo Span mm	COD.	COD.	Sovrapprezzo Surcharge	COD.	Sfusa Loose
175	160	T04L	U00V	-	VF30.11D	

H Ht mm	20	Sporgenza Projection mm	35
---------------	----	-------------------------------	----

Maniglie con foratura VERTICALE
Handles with VERTICAL drilling
 Maniglie con foratura ORIZZONTALE
Handles with HORIZONTAL drilling

AB3C Albicocca	EG4L Blu Egeo	RC3Q Rovere cognac
AL1A Alluminio	GL4R Grigio Dorian	RG9L Rovere gesso
AS7H Alluminio spazzolato	GZ8A Giallo zafferano	RS4B Royal oak
BI7A Bianco opaco	GZ8T Grigio titanio	RW3Q Rovere white
CB6K Ciliegio bianco	LV5T Oliva	
CQ3Q Cadaques	NS3Q Nero spazzolato	
CS4B Champagne spazzolato	OR7L Orchidea	

PUL



L W mm	Passo Span mm	COD.	COD.	Sovrapprezzo Surcharge	COD.	Sfusa Loose
192	160	G28P	G53Z		VF30.12L	

H Ht mm	18	Sporgenza Projection mm	19
---------------	----	-------------------------------	----

PURA

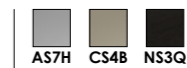

L W mm	Passo Span mm	COD.	COD.	Sovrapprezzo Surcharge	COD.	Sfusa Loose
192	160	E76R	E75C		VF30.18Z	

H Ht mm	16	Sporgenza Projection mm	18
---------------	----	-------------------------------	----

SAK



L W mm	Passo Span mm	COD.	COD.	Sovrapprezzo Surcharge	COD.	Sfusa Loose
180	160	E04U	T06R		VF30.13S	

H Ht mm	14	Sporgenza Projection mm	35
---------------	----	-------------------------------	----

BLADE



L W mm	Passo Span mm	COD.	COD.	Sovrapprezzo Surcharge	COD.	Sfusa Loose
445	-	-	H01A		VF30.14Y	
595	-	-	H02E		VF30.15E	
895	-	-	H03M		VF30.16M	
1195	-	-	H05Z	H04F	VF30.17T	

H Ht mm	14	Sporgenza Projection mm	20
---------------	----	-------------------------------	----

TALL

! **Maniglia a tutta altezza.**
Negli elementi con coppia ante
è prevista una sola maniglia.
Full-height handle.
Elements with two doors have
only one handle.



L W mm	Passo Span mm	COD.		COD.		Sovrapprezzo Surcharge	COD.	Sfusa Loose
154	-	H06B		-			VF29.90B	
314	-						VF29.91H	
634	-						VF29.92Q	
954	-						VF29.93W	
1274	-						VF29.94C	
1594	-						VF29.95K	
1914	-						VF29.96R	
2234	-						VF29.97X	
2554	-						VF29.98D	

H Ht mm	33	Sporgenza Projection mm	26
---------------	----	-------------------------------	----

 **Maniglie con foratura VERTICALE**
Handles with VERTICAL drilling

 **Maniglie con foratura ORIZZONTALE**
Handles with HORIZONTAL drilling

AB3C Albicocca
AL1A Alluminio
AS7H Alluminio spazzolato
BI7A Bianco opaco
CB6K Ciliegio bianco
CQ3Q Cadaques
CS4B Champagne spazzolato

EG4L Blu Egeo
GL4R Grigio Dorian
GZ8A Giallo zafferano
GZ8T Grigio titanio
LV5T Oliva
NS3Q Nero spazzolato
OR7L Orchidea

RC3Q Rovere cognac
RG9L Rovere gesso
RS4B Royal oak
RW3Q Rovere white

Posizionamento pomelli e maniglie

Knobs and handles position

Schema pomelli
Knobs diagram

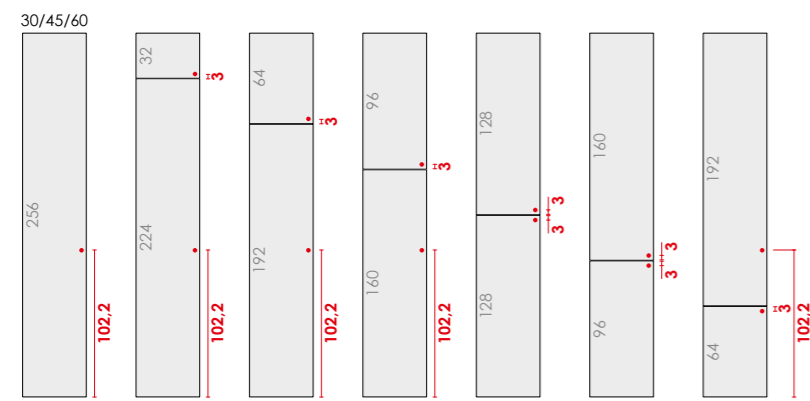

Anta vasistas H 32
Ht 32 vasistas door

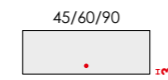

Anta ribalta H 32
Ht 32 folding door

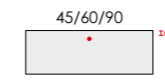

Cassetti H 16
Ht 16 drawers

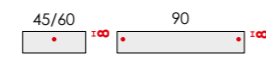

Cassettoni H 32
Ht 32 big drawers



Cassettone sotto letto
H 23,6
Ht 23.6 under-bed big drawer

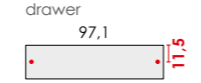

Cassetti H 16 per
cassettiere interne
Ht 16 drawers for
internal drawer units

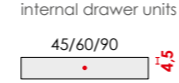

Schema maniglie passo 3,2
Pitch 3.2 handles diagram

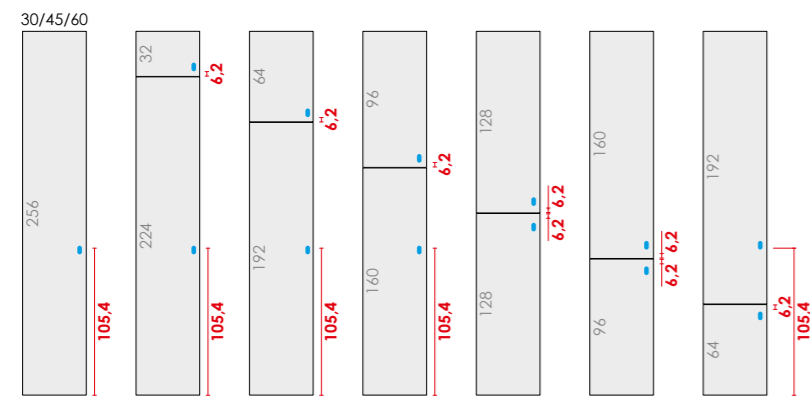
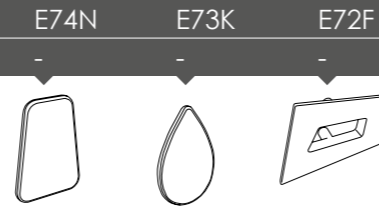

Anta vasistas H 32
Ht 32 vasistas door

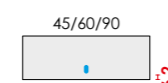

Anta ribalta H 32
Ht 32 folding door

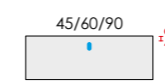

Cassetti H 16
Ht 16 drawers



Cassettoni H 32
Ht 32 big drawers



Cassettone sotto letto
H 23,6
Ht 23.6 under-bed big drawer

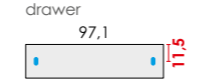

Cassetti H 16 per
cassettiere interne
Ht 16 drawers for
internal drawer units

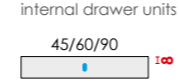

Schema maniglie passo 9,6
Pitch 9.6 handles diagram

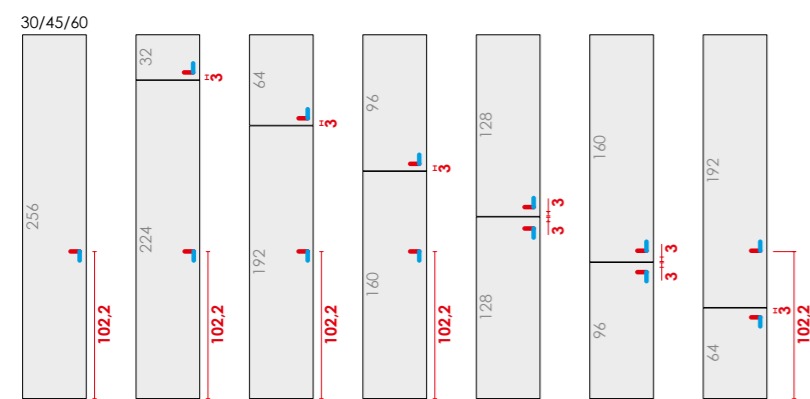
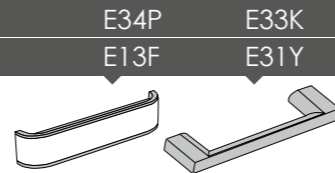

Anta vasistas H 32
Ht 32 vasistas door

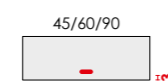

Anta ribalta H 32
Ht 32 folding door

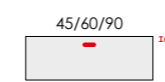

Cassetti H 16
Ht 16 drawers



Cassettoni H 32
Ht 32 big drawers



Cassettone sotto letto
H 23,6
Ht 23.6 under-bed big drawer



Cassetti H 16 per
cassettiere interne
Ht 16 drawers for
internal drawer units

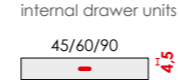

Schema maniglie passo 16
Pitch 16 handles diagram

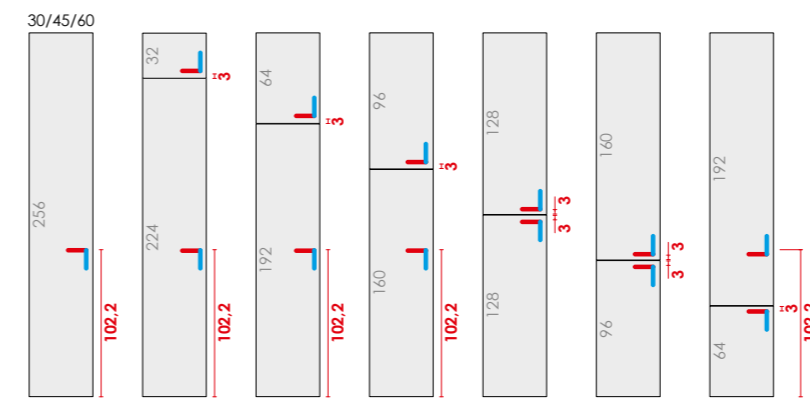
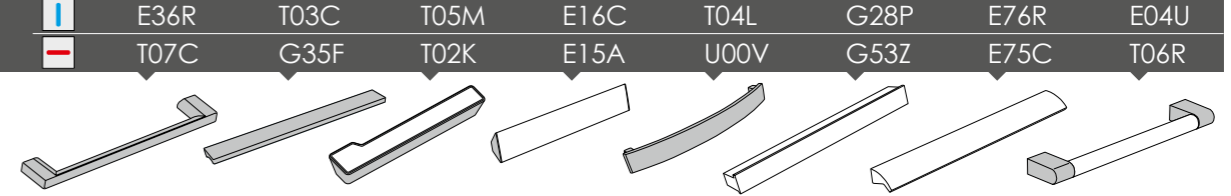

Anta vasistas H 32
Ht 32 vasistas door

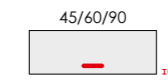

Anta ribalta H 32
Ht 32 folding door

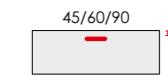

Cassetti H 16
Ht 16 drawers

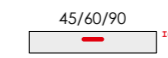

Cassettoni H 32
Ht 32 big drawers

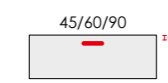

Cassettone sotto letto
H 23,6
Ht 23.6 under-bed big drawer

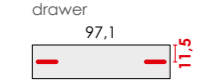

Cassetti H 16 per
cassettiere interne
Ht 16 drawers for
internal drawer units

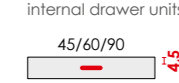

Schema maniglie BLADE
BLADE handles diagram

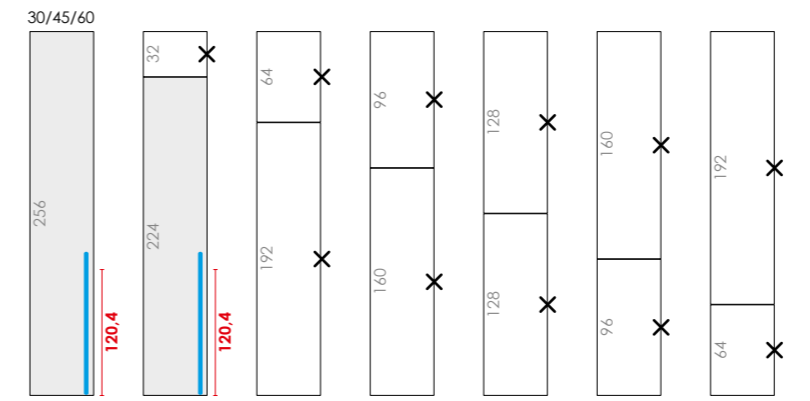
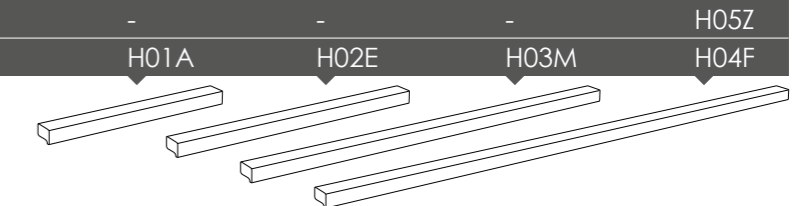

Anta vasistas H 32
Ht 32 vasistas door

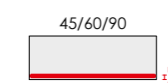

Anta ribalta H 32
Ht 32 folding door

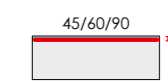

Cassetti componibili H 16
Ht 16 modular units drawers

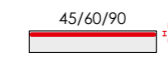

Cassettoni componibili H 32
Ht 32 modular units big drawers

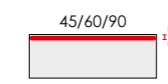

Cassettone sotto letto
H 23,6
Ht 23.6 under-bed big drawer

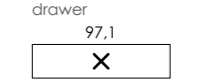

Cassetti H 16 per
cassettiere interne
Ht 16 drawers for
internal drawer units

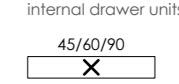

Schema maniglie TALL
TALL handles diagram

H06B

⚠ **Maniglie a tutta altezza. Negli elementi con coppia ante è prevista una sola maniglia.**
Full-height handle. Elements with two doors have only one handle.

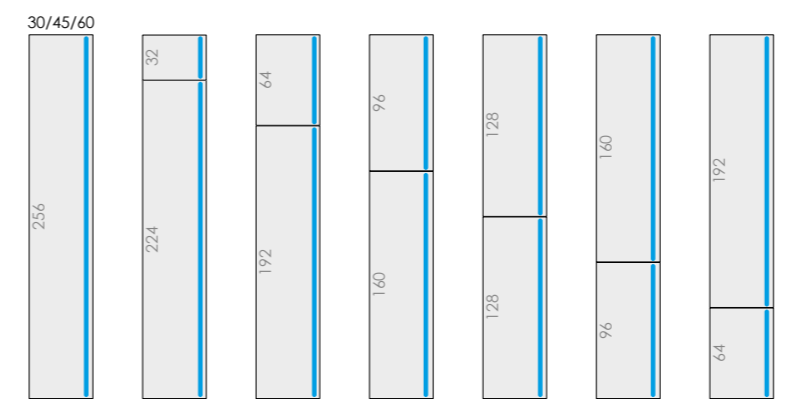

Anta vasistas H 32
Ht 32 vasistas door

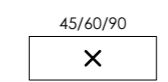

Anta ribalta H 32
Ht 32 folding door

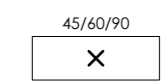

Cassetti H 16
Ht 16 drawers



Cassettoni H 32
Ht 32 big drawers



Cassettone sotto letto
H 23,6
Ht 23.6 under-bed big drawer

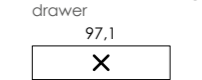

Cassetti H 16 per
cassettiere interne
Ht 16 drawers for
internal drawer units

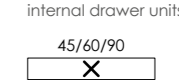

- Maniglie con foratura VERTICALE**
Handles with VERTICAL drilling
- Maniglie con foratura ORIZZONTALE**
Handles with HORIZONTAL drilling
- Le maniglie non si possono montare**
The handles indicated cannot be assembled

Cerniere Hinges

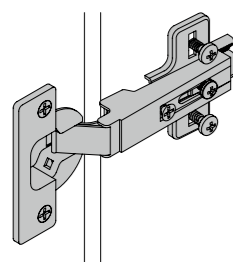

Rallentatore di chiusura per ante battente Closing retainer for hinged doors

* Il rallentatore di chiusura è applicabile alle cerniere indicate.
The closing retainer is applicable to the indicated hinges.

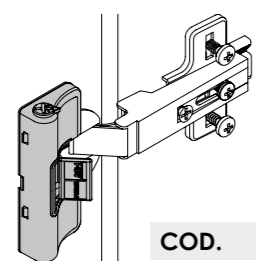

Singolo
(per ante H 32-64-96-128-160-192)
Single
(for doors Ht 32-64-96-128-160-192)

COD. VF32.00A

Doppio
(per ante H 224-256)
Double
(for doors Ht 224-256)

COD. VF32.01G

Descrizione: Description:	COD.	Da utilizzare su: To be used on:
Cerniera a 110° completa di basetta (4 pezzi) 110° hinge with mounting plate (4 pieces)	VF32.02P *	Ante armadi ed elementi sopra-barra Doors for wardrobes and over bar elements
Cerniera a 180° completa di basetta (4 pezzi) 180° hinge with mounting plate (4 pieces)	VF32.03V	Ante angoli interi armadio Doors for corner wardrobes
Cerniera a 45° completa di basetta (4 pezzi) 45° hinge with mounting plate (4 pieces)	VF32.04B *	Ante cabine ad angolo Doors for corner walk-in wardrobes
Cerniera a 30° completa di basetta (4 pezzi) 30° hinge with mounting plate (4 pieces)	VF32.05H *	Ante terminali End units doors
Cerniera in luce completa di basetta (2 pezzi) Flush hinge with mounting plate (2 pieces)	VF32.06Q *	Ante scalette, armadio P 90 per letti a soppalco BRIDGE e cabina REVOLUTION Ladders, BRIDGE loft beds Dpt 90 and REVOLUTION walk-in wardrobe doors
Cerniera decelerata 110° completa di basetta (4 pezzi) 110° decelerate hinge with mounting plate (4 pieces)	VF32.07W	Ante libreria INFINITY Doors for INFINITY bookshelf
Cerniera a 110° completa di basetta (4 pezzi) 110° hinge with mounting plate (4 pieces)	VF32.08C *	Ante armadio REVOLUTION e componibili REVOLUTION wardrobe and modular units doors

Rallentatore di chiusura per cassetto Closing retainer for drawers

È sufficiente 1 rallentatore per i cassetti L 45 / 60 / 90 e cassettoni L 45 / 60.
Sui cassettoni L 90 sono necessari 2 rallentatori.
1 closing retainer is sufficient for drawers W 45 / 60 / 90 and big drawers W 45 / 60.
2 closing retainers are required on big drawers W 90.

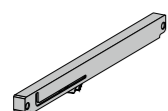

COD. VF32.11N

Guide metalliche regolabili in altezza per cassetti e cassettoni (2 pezzi) Metal runners adjustable in height for drawers and big drawers (2 pieces)



COD. VF32.12U



COD. VF32.13A

Guide metalliche tipo "Quadro" regolabili in altezza per cassetti e cassettoni (2 pezzi) Type "Quadro" metal runners adjustable in height for drawers and big drawers (2 pieces)



COD. VF35.01V

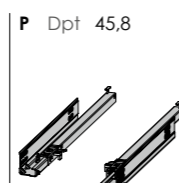

COD. VF35.02B

Reggi fondino per cassetti e cassettoni Bottom panel support for drawers and large drawers

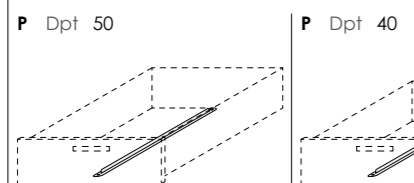

COD. VF32.14G

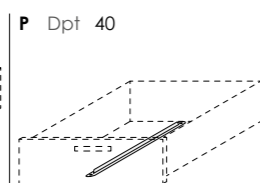

COD. VF32.15P

Cricchetto per apertura PUSH-PULL 1 pezzo PUSH-PULL opening system ratchet 1 piece

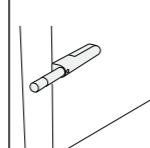

COD. VF32.16V

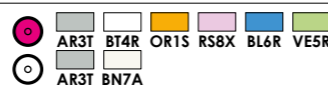
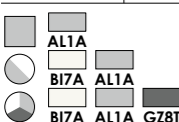

Provvisti di ferramenta per fissaggio a pannello.
In caso di fissaggio a muro la scelta del tipo di tassello da utilizzare dovrà essere fatta dal montatore sulla base delle caratteristiche della parete.
Complete with hardware for fixing to panel.
In case of wall fixing the choice of hardware depends on the wall conditions and should be made by the assembler.

<p>Kit 4 piedini circolari salvamobile H 0,5 Ø 2 Kit 4 circular feet Ht 0.5 Ø 2</p> <p>COD. VF32.17B</p>	<p>Kit 4 piedini rettangolari salvamobile H 0,7 Kit 4 rectangular feet Ht 0.7</p> <p>COD. VF32.18H</p>	<p>Piedini regolabili per armadi (2 pezzi) 1 Kit ogni fianco Adjustable feet for wardrobes (2 pieces) 1 Kit per side panel</p> <p>COD. VF32.19Q</p>	<p>Piedini regolabili per armadi con ante scorrevoli (4 pezzi) Adjustable feet for wardrobes with sliding doors (4 pieces)</p> <p>COD. VF32.20M</p>	<p>Piedini regolabili H 0,8 per libreria INFINITY (4 pezzi) Adjustable feet Ht 0.8 for INFINITY bookshelf (4 pieces)</p> <p>COD. VF32.21T</p>
<p>Piedini regolabili per pannelli ponte (2 pezzi per pannello) Adjustable feet for overhead structure panels (2 pieces for panel)</p> <p>COD. VF32.22Z</p>	<p>Reggipiani in metallo per ripiani in nobilitato (4 pezzi) Metal shelves supports for melamine shelves (4 pieces)</p> <p>COD. VF32.23F</p>	<p>Reggipiani in metallo per ripiani in vetro (4 pezzi) Metal shelves supports for glass shelves (4 pieces)</p> <p>COD. VF32.24N</p>	<p>Piastrine reggi rete in metallo per letti (4 pezzi) Metal plates for bed base support for beds (4 pieces)</p> <p>COD. VF32.25U</p>	<p>Coppia staffe per aggancio testata al giroletto metallico Pair of brackets for fixing headboard to metal bed frame</p> <p>COD. VF32.26A</p>
<p>Coppie reggimensola Couple shelf holders</p> <p>A scomparsa Integrated</p> <p>COD. VF32.27G</p>	<p>LAMPO L W 3,5 P Dpt 8</p> <p>Apertura: Opening: min 1,5 max 3,5</p> <p>COD. VF32.28P</p>	<p>KUB L W 3 P Dpt 4</p> <p>Apertura: Opening: min 2 max 4</p> <p>COD. VF32.29V</p>	<p>Appendi abiti scorrevole Sliding clothes rail</p> <p>Consigliati per armadi ridotti in profondità: P 40 = per profondità superiori a 40 cm. P 24,5 = per profondità inferiori a 40 cm. Recommended for wardrobes with small depth: Dpt 40 = for depth greater than 40 cm. Dpt 24.5 = for depth less than 40 cm.</p> <p>COD. VF32.30S</p> <p>COD. VF32.31Y</p>	
<p>Piedini regolabili - Confezione 4 pezzi Adjustable feet - Pack of 4</p> <p>ALFA 16 H Ht 1,6</p> <p>COD. VF33.86N</p>	<p>ALFA 25 H Ht 2,5</p> <p>COD. VF32.32E</p>	<p>ETA L W 10 H Ht 4</p> <p>COD. VF32.33M</p>	<p>SIGMA L W 8,3 H Ht 11</p> <p>COD. VF32.34T</p>	<p>GAMMA L W 3,6 H Ht 11</p> <p>centrale central</p> <p>COD. VF32.35Z</p>
<p>Coppia piedi cilindrici trasparenti Per letti Pair of transparent cylindrical feet For beds</p> <p>Ø 7 H Ht 23,7</p> <p>COD. VF32.36F</p>	<p>Kit 2 ruote con freno Per letti Set 2 casters with brake For beds</p> <p>Ø 12 H Ht 23,7</p> <p>COD. VF32.37N</p>	<p>Kit 4 ruote con freno Per cassettiere Set 4 casters with brake For chest of drawers</p> <p>Ø 6 H Ht 8</p> <p>COD. VF32.38U</p>	<p>Kit 4 ruote senza freno Per cassettiere e porta PC Set 4 casters without brake For chest of drawers and PC holder</p> <p>L W 6 H Ht 8</p> <p>COD. VF32.39A</p>	<p>Parapolvere Dust blocker</p> <p>Per ante a battente Taglio a cura del montatore For hinged doors Cut by assembler</p> <p>255,6</p> <p>COD. VF32.40X</p>

Campionari e vernici

Colour sample sets and paints

Pannello campionario colori

Colour samples panel

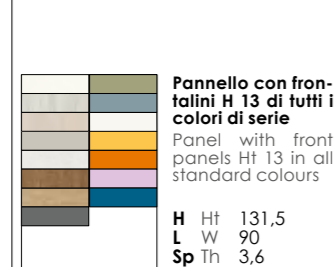

Pannello con frontalini H 13 di tutti i colori di serie
Panel with front panels Ht 13 in all standard colours

H Ht 131,5
L W 90
Sp Th 3,6

Kit aggiornamento con biadesivo

Updating kit with double-sided tape

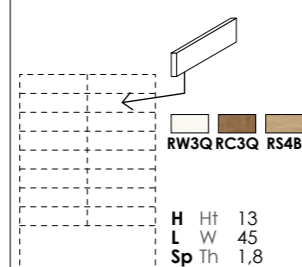

H Ht 13
L W 45
Sp Th 1,8

Ordinabili sulla divisione "Materiali punto vendita"
Can be ordered from the "Point of Sale Materials" division

Vernice in bottiglietta per ritocchi

Bottle of paint for repairs

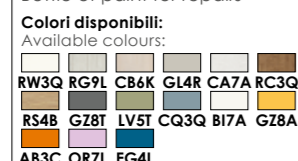

Colori disponibili:
Available colours:
RW3Q RG9L CB6K GL4R CA7A RC3Q
RS4B GZ8T LV5T CQ3Q B17A GZ8A
AB3C OR7L EG4L

10 ml

Vernice e fondo all'acqua (2 barattoli da 500 ml cadauno)

Water-based primer and paint (2 tins of 500 ml each)

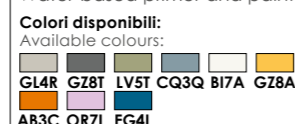

Colori disponibili:
Available colours:
GL4R GZ8T LV5T CQ3Q B17A GZ8A
AB3C OR7L EG4L

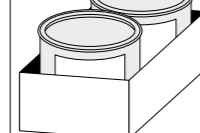

COD. VF32.44Y

COD. VF32.45E

Pannelli e bordi

Panels and edged

L'altezza del pannello è definita dal disegno verticale della venatura del legno (se presente)
Height of panel is defined by the vertical matching of the wood grain (if any)

Pannelli bordati

Edged panels

Sp 1,8
Th 1,8

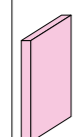

H Ht 268 Max
L W 90 Max
H Ht 24 Min
L W 12 Min

Pannelli bordati

Edged panels

Sp 2,5
Th 2,5

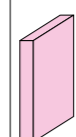

H Ht 265 Max
L W 90 Max
H Ht 24 Min
L W 12 Min

Pannelli non bordati

Panels without edge

Sp 1,8
Th 1,8

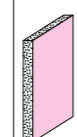

H Ht 268 Max
L W 90 Max
H Ht 24 Min
L W 12 Min

Pannelli non bordati

Panels without edge

Sp 2,5
Th 2,5

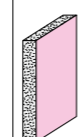

H Ht 265 Max
L W 90 Max
H Ht 24 Min
L W 12 Min

COD. VF32.46M

COD. VF32.47T

COD. VF32.48Z

COD. VF32.49F

A
B

Bordo sfuso precollato per pannelli a misura e fianchi

Edging pre-glued for custom-made panels and side panels

Edging pre-glued for custom-made panels and side panels

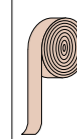

H Ht 2,8
Sp Th 0,04

Bordo sfuso in ABS non adesivo

Edging in ABS not adhesive

Edging in ABS not adhesive

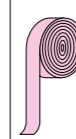

H Ht 2,8
Sp Th 0,08

Coprifori adesivi

Sticky hole covers

Sticky hole covers

(8 pezzi Ø 13 mm)
(8 pieces Ø 13 mm)

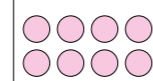

(8 pezzi Ø 20 mm)
(8 pieces Ø 20 mm)

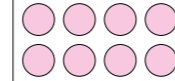

COD. VF32.50C

COD. VF32.51K

COD. VF32.53X

COD. VF32.54D



Illuminazione

Lighting

Faretto LED Ø 6,5

LED spotlights Ø 6.5

12 volt 1,7 watt.
12 volt 1.7 watt.

Da completare con alimentatore
To be completed with power pack

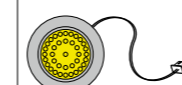

COD. VF32.55L

Alimentatore

Power pack

(cavo L 200 cm - 20 watt) in grado di supportare da 1 a 6 faretti
(cable W 200 cm - 20 watt) can power from 1 to 6 spotlights

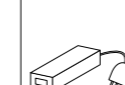

COD. VF32.56S

Interruttore wireless

Wireless switch

Wireless switch

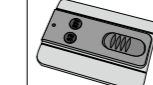

COD. VF32.57Y

Lampada LED

LED lamp

Dotata di batteria al litio integrata ricaricabile tramite cavo micro USB (non incluso). Applicabile con le viti fornite o con calamite adesive.
Con sensore di presenza.
Equipped with integrated lithium battery rechargeable via micro USB cable (not included). Applied with the supplied screws or with adhesive magnets.
With presence sensor.

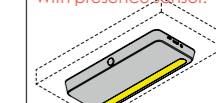

L W 15
P Dpt 6,5
H Ht 1,4

COD. VF32.58E

Illuminazione con sensore

Lighting with sensor

Lighting with sensor

Kit completi di 1 alimentatore. Cover colore Alluminio e Titanio.
Complete kits with 1 power pack. Cover color Aluminum and Titanium.

L W 11,2
P Dpt 19,2
Sp Th 0,6

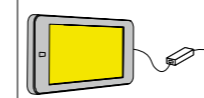

COD. VF32.63C

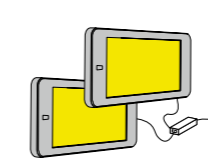

COD. VF32.64K

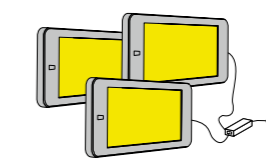

COD. VF32.65R

Kit illuminazione led per testate letti.

Led lighting kit for bed headboards.

Led lighting kit for bed headboards.

Fascia led L 120, 1 interruttore, cablaggi
Led strip W 120, 1 switch, wiring

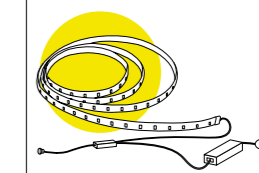

COD. VF34.00K

Lampada led SPARK

SPARK LED lighting

SPARK LED lighting

Interruttore manuale o sensore di luce azionabile con interruttore laterale. Applicabile con le viti fornite o con velcro biadesivo. 3 batterie da 1,5v AAA non incluse.

Manual switch or light sensor that can be operated with the side switch. Applied with the provided screws or with biadhesive velcro. 3 - 1.5v AAA batteries not included.



Ø 9,1
Sp Th 4,4

COD. VF32.59M

Lampada led SKY

SKY LED lighting

SKY LED lighting

Interruttore touch integrato. Applicabile con le viti fornite o con biadesivo. 3 batterie da 1,5v AAA non incluse.

Built-in touch switch. Applied with the provided screws or with biadhesive tape. 3 - 1.5v AAA batteries not included.

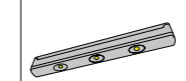

H Ht 2,2
L W 17
P Dpt 1,5

COD. VF32.60H

Lampada led SMARTY

SMARTY led lamp

SMARTY led lamp

Dotata di batteria integrata ricaricabile tramite cavo USB (incluso). Si aggancia a due placche magnetiche applicabili con viti o biadesivo forniti. Con sensore di presenza.

Equipped with integrated battery rechargeable via USB cable (included). Attaches to two magnetic plates that can be applied with the screws or double-sided tape provided. **With presence sensor.**

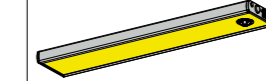

L W 40,5
P Dpt 4
H Ht 1

COD. VF34.99S

Appendiabiti

Clothes hook

BOLLINO

BOLLINO

Ø 10
P Dpt 4

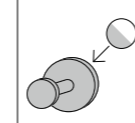

COD. VF32.61Q

PLUS

PLUS

H Ht 6,5
L W 4,3
P Dpt 3

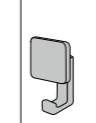

COD. VF32.62W

KART

Scocca in polipropilene termoformato. Struttura in tubolare metallico colore Alluminio (AL1A).
Thermoformed polypropylene seat. Metal tubular structure in Aluminium (AL1A) colour.

H Ht 83 seduta
L W 43,5 seat
P Dpt 50 H Ht 46

Colori disponibili:
Available colours:
Y33R Z13K Z15L Z14G Z35F Z16R



COD. VF32.66X

KART
Con ruote e girevole

Elevazione a gas. Scocca in polipropilene termoformato. Struttura colore nero.
Pneumatic suspension. Thermoformed polypropylene shell. Black frame.

H Ht 93 seduta
L W 58 seat
P Dpt 58 H Ht 43+53

Colori disponibili:
Available colours:
Y33R Z13K Z15L Z14G Z35F Z16R



COD. VF32.67D

GIROTONDO
Con ruote e girevole

Elevazione meccanica. Fondino in tessuto. Struttura in metallo.
Mechanical lift system. Seat covered with fabric. Metal structure.

H Ht 93 seduta
L W 55 seat
P Dpt 55 H Ht 45,3+60

Colori struttura:
Structure colours:
GZ8T GL4R LV5T BI7A GZ8A
AB3C OR7L EG4L AL1A

Colore seduta:
Seat colour:
X22K



COD. VF32.75W

FLEA

Fondino e schienale in polipropilene. Struttura in metallo.
PVC seat and back. Metal structure.

H Ht 75 seduta
L W 40 seat
P Dpt 47 H Ht 46,8

Colori disponibili:
Available colours:
LV5T BI7A GZ8A OR7L

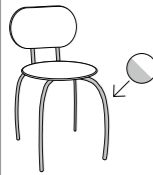

COD. VF32.68L

FLEA
Con ruote e girevole

Fondino e schienale in polipropilene. Struttura e ruote in ABS grigio.
Seat and back in polypropylene. Structure and wheels in ABS grigio.

H Ht 96,5 seduta
L W 62 seat
P Dpt 62 H Ht 57+44,5

Colori disponibili:
Available colours:
LV5T BI7A GZ8A OR7L

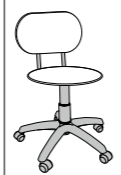

COD. VF32.69S

PUNTO
Con ruote e girevole

Elevazione a gas. Fondino e schienale in plastica atossica. Struttura colore grigio.
Pneumatic suspension. Back and seat in non-toxic plastic. Structure in grey colour.

H Ht 76+87,5 seduta
L W 60 seat
P Dpt 60 H Ht 39+50,5

Colori disponibili:
Available colours:
Z01B X27A X28D X29G Z02K Z17W X31H X32M

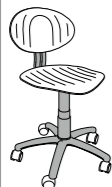

COD. VF32.70P

TRAK
Con ruote e girevole

Elevazione meccanica. Scocca in polipropilene termoformato. Struttura in metallo.
Mechanical lift system. Thermoformed polypropylene shell. Metal structure.

H Ht 92,5 seduta
L W 60 seat
P Dpt 60 H Ht 42+55

Colori struttura:
Structure colours:
GZ8T GL4R LV5T BI7A GZ8A
AB3C OR7L EG4L AL1A

Colori seduta:
Seat colours:
Y33R Z13K Z15L
Z14G Z35F Z16R



COD. VF32.71V

RUNNER
Con ruote e girevole

Elevazione a gas. Scocca in polipropilene termoformato. Struttura e ruote colore grigio.
Pneumatic suspension. Thermoformed polypropylene shell. Structure and wheels in grey colour.

H Ht 77+90 seduta
L W 44 seat
P Dpt 50 H Ht 42+55

Colori disponibili:
Available colours:
Z75N Z76R Z77U Z78X



COD. VF32.72B

LIPSIA

Non sfoderabile. Poliuretano flessibile densità 25 kg/m³.
Covers not removable. Flexible polyurethane, density 25 kg/m³.

H Ht 99 seduta
L W 45 seat
P Dpt 58 H Ht 49

Colori disponibili:
Available colours:
RW3Q GL4R

Colore seduta:
Seat colour:
0025 0021 0031
RITUAL - RV26RT



COD. VF32.73H

NOEMI

Fondino e struttura in legno.
Wooden seat and structure.

H Ht 82 seduta
L W 44 seat
P Dpt 51 H Ht 45

Colori disponibili:
Available colours:
GZ8T GL4R LV5T BI7A GZ8A OR7L EG4L



COD. VF32.74Q

ARIES

Fondino e struttura in propilene.
Propylene seat and structure.

H Ht 82 seduta
L W 48 seat
P Dpt 47 H Ht 46

COD.
JA11.03M Bianco ottico
JA11.04T Rosso
JA11.05Z Tortora
JA11.06F Nero



Tavoli DALLAS
DALLAS tables

QUADRATO
Tavoli con piano e telaio in nobilitato e gambe in legno
SQUARE
Tables with laminate top and frame and wooden legs

Colori disponibili:
Available colours:
A → RW3Q RD5T CB6K
B → GZ8T

COD. A B

Fisso
Fixed

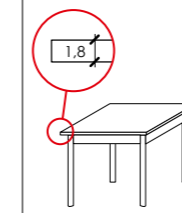

H Ht 77
L W 90
P Dpt 90

COD. VF35.11A

Raddoppiabile
Doubling-up

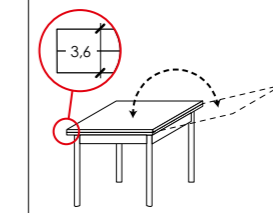

H Ht 78,6
L W 90 (180)
P Dpt 90

COD. VF35.12G

RETTANGOLARE
Tavoli con piano e telaio in nobilitato e gambe in legno
RECTANGULAR
Tables with laminate top and frame and wooden legs

Colori disponibili:
Available colours:
A → RW3Q RD5T CB6K
B → GZ8T

COD. A B

Fisso
Fixed

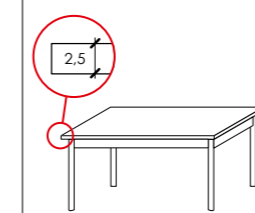

H Ht 77,5
L W 160
P Dpt 85

COD. VF35.13P

Allungabile
Extensible

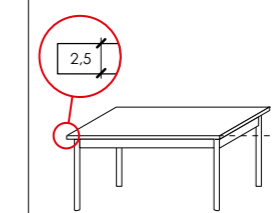

H Ht 77,5
L W 160 (200)
P Dpt 85

COD. VF35.14V

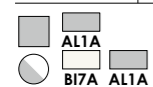

Componenti colore Nero
Components in black colour
Idrorepellente antimacchia.
Water-repellent stain.
Rivestimenti selezionati dalla collezione SOFUP.
Selected coatings from the collection SOFUP.

Ante Doors

per Armadi ed Elementi sopra-barra

for Wardrobes and Over-bar elements

L
W 30

Specificare cerniera Sx o Dx
Specify hinge L or R

COD.		VF30.19F	VF30.20C
VOLO	(A) (B)		
WINDOW			

Ante Doors

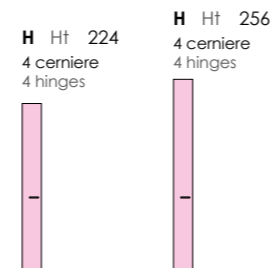

per Armadi ed Elementi sopra-barra

for Wardrobes and Over-bar elements

L
W 45

Specificare cerniera Sx o Dx
Specify hinge L or R

COD.	VF30.30H	VF30.31Q	VF30.32W	VF30.33C	VF30.34K	VF30.35R	VF30.36X	VF30.37D
VOLO	(A) (B)							
WINDOW								

Ante Doors

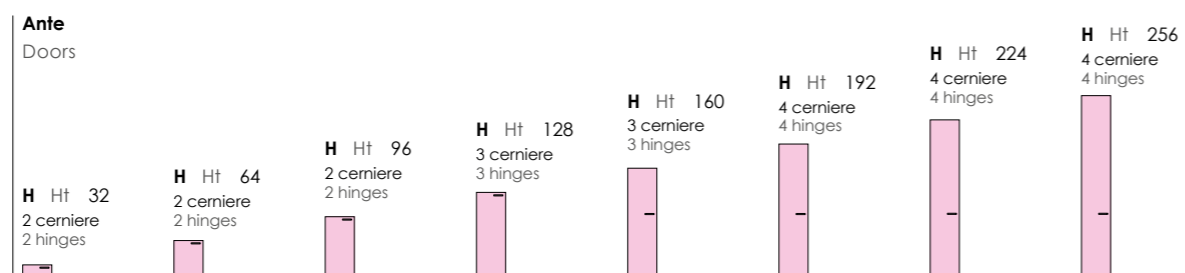

per Angoli interi

for Corner wardrobes

Coppia ante

Pair of doors

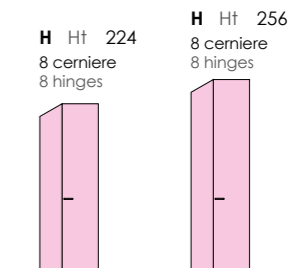

COD.		VF30.54V	VF30.55B
VOLO	(A) (B)		

per Armadi

for Wardrobes

L
W 45

Specificare cerniera Sx o Dx
Specify hinge L or R

COD.		VF30.21K	VF30.22R
VOLO	(A) (B)		

Ante specchio (dotate di pomello SEM)

La fascia prezzo è determinata dalla finitura del pannello sul quale viene applicato lo specchio
Mirror doors (equipped with SEM knob)
The price range is determined by the finish of the panel on which the mirror is applied

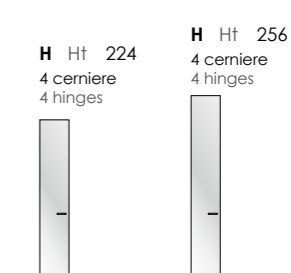

per Armadi ed Elementi sopra-barra

for Wardrobes and Over-bar elements

L
W 60

Specificare cerniera Sx o Dx
Specify hinge L or R

COD.	VF30.38L	VF30.39S	VF30.40P	VF30.41V	VF30.42B	VF30.43H	VF30.44Q	VF30.45W
VOLO	(A) (B)							
WINDOW								

Ante Doors



per Armadi

for Wardrobes

L
W 60

Specificare cerniera Sx o Dx
Specify hinge L or R

COD.		VF30.23X	VF30.24D
VOLO	(A) (B)		

Ante specchio (dotate di pomello SEM)

La fascia prezzo è determinata dalla finitura del pannello sul quale viene applicato lo specchio
Mirror doors (equipped with SEM knob)
The price range is determined by the finish of the panel on which the mirror is applied

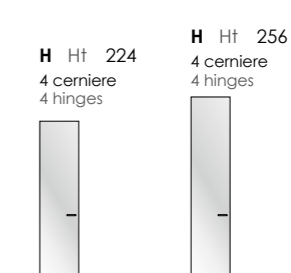

per Armadi ed Elementi sopra-barra

for Wardrobes and Over-bar elements

L
W 90

Specificare cerniera Sx o Dx
Specify hinge L or R

COD.	VF30.46C	VF30.47K	VF30.48R	VF30.49X	VF30.50U	VF30.51A	VF30.52G	VF30.53P
VOLO	(A) (B)							
WINDOW								

Coppia ante

Pair of doors

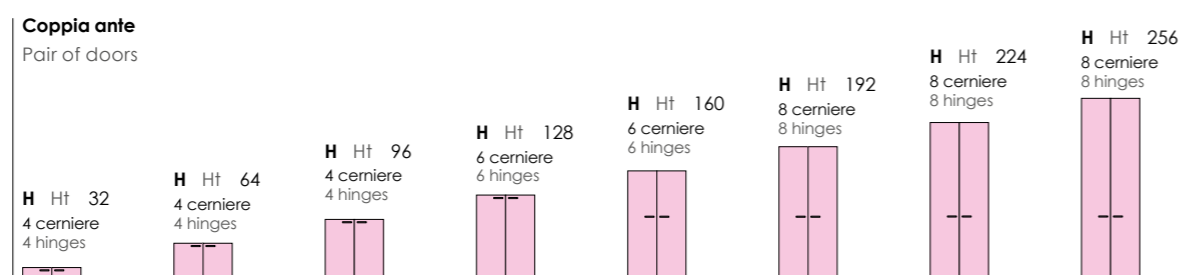

per Armadi

for Wardrobes

L
W 90

Specificare cerniera Sx o Dx
Specify hinge L or R

COD.		VF30.25L	VF30.26S
VOLO	(A) (B)		

Ante specchio (dotate di pomello SEM)

La fascia prezzo è determinata dalla finitura del pannello sul quale viene applicato lo specchio
Mirror doors (equipped with SEM knob)
The price range is determined by the finish of the panel on which the mirror is applied

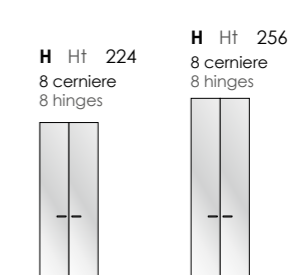

Ante Doors

per Pensili
for Hanging units

L
W **30**

Specificare cerniera Sx o Dx
Specify hinge L or R

COD.	VF30.27Y	VF30.68B	VF30.69H	VF30.28E
VOLO	(A)	(B)	(A)	(B)
WINDOW				

Ante
Doors

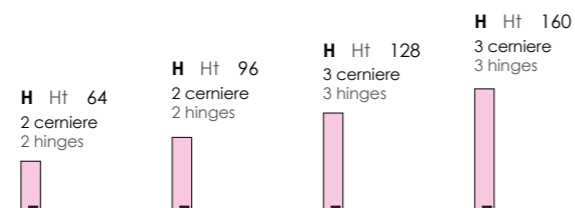

per Componibili
e Pensili
for Modular units
and Hanging units

L
W **45**

Specificare cerniera Sx o Dx
Specify hinge L or R

COD.	VF30.56H	VF30.57Q	VF30.58W	VF30.59C	VF30.29M
VOLO	(A)	(B)	(A)	(B)	(A)
WINDOW					

Ante
Doors

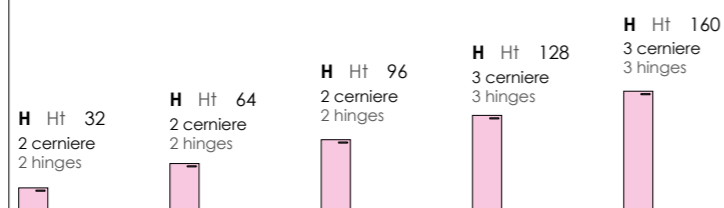

per Componibili
e Pensili
for Modular units
and Hanging units

L
W **60**

Specificare cerniera Sx o Dx
Specify hinge L or R

COD.	VF30.60Z	VF30.61F	VF30.62N	VF30.63U
VOLO	(A)	(B)	(A)	(B)
WINDOW				

Doors

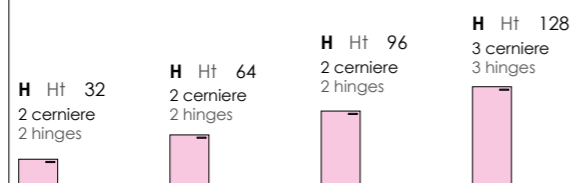

per Componibili
e Pensili
for Modular units
and Hanging units

L
W **90**

Specificare cerniera Sx o Dx
Specify hinge L or R

COD.	VF30.64A	VF30.65G	VF30.66P	VF30.67V
VOLO	(A)	(B)	(A)	(B)
WINDOW				

Coppia ante
Pair of doors

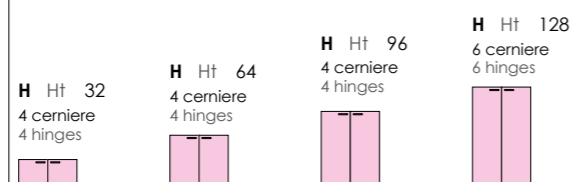

Cassetti e cassettoni VOLO VOLO drawers and big drawers

per Armadi P 56,3
for Wardrobes Dpt 56.3

P
Dpt **51,8**

L W	COD.	Cassetti H 16 Drawers Ht 16			Cassettoni H 32 Big drawers Ht 32	
		VF30.70E	VF30.71M	VF30.72T	VF30.73Z	VF30.74F
45	VOLO	(A)	(B)	(A)	(B)	(A)
60	VOLO	(A)	(B)	(A)	(B)	(A)
90	VOLO	(A)	(B)	(A)	(B)	(A)

per Componibili P 45,8
for Modular units Dpt 45.8

P
Dpt **41,8**

L W	COD.	Cassetti H 16 Drawers Ht 16			Cassettoni H 32 Big drawers Ht 32	
		VF30.85T	VF30.86Z	VF30.87F	VF30.88N	VF30.89U
45	VOLO	(A)	(B)	(A)	(B)	(A)
60	VOLO	(A)	(B)	(A)	(B)	(A)
90	VOLO	(A)	(B)	(A)	(B)	(A)

Coppia cassettoni
sottoletto

Pair of under-bed
big drawers

H Ht 24,6
L W 97 x 2



COD.	VF31.00W
VOLO	(A)
	(B)

Maniglie, accessori,
sedie e tavoli
Handles, accessories,
chairs and tables

Pannello anta VOLO senza fori cerniera e maniglia

VOLO door panel without hinge and handle holes

Sp
Th **1,8**

In fase d'ordine specificare
altezza (H) e larghezza (L)
del pannello anta

When making the order specify
height (Ht) and width (W) of the
door panel

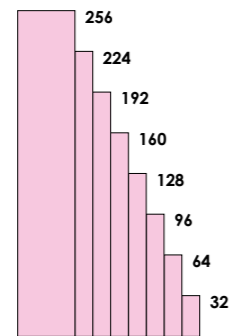

COD.		VF31.01C					
		L W 29,7 (30)		L W 44,7 (45)		L W 59,7 (60)	
H	Ht 31,6 (32)	<input type="radio"/> A					
		<input type="radio"/> B					
H	Ht 63,6 (64)	<input type="radio"/> A					
		<input type="radio"/> B					
H	Ht 95,6 (96)	<input type="radio"/> A					
		<input type="radio"/> B					
H	Ht 127,6 (128)	<input type="radio"/> A					
		<input type="radio"/> B					
H	Ht 159,6 (160)	<input type="radio"/> A					
		<input type="radio"/> B					
H	Ht 191,6 (192)	<input type="radio"/> A					
		<input type="radio"/> B					
H	Ht 223,6 (224)	<input type="radio"/> A					
		<input type="radio"/> B					
H	Ht 255,6 (256)	<input type="radio"/> A					
		<input type="radio"/> B					

Facciate Fronts
VOLO

Finiture GRUPPO 1
GROUP 1 finishes

Finiture GRUPPO 2
GROUP 2 finishes

Rovere white*

A ☆ Rovere white RW3Q	A ☆ Rovere gesso RG9L	A ☆ Ciliegio bianco CB6K	A Grigio Dorian GL4R	B ☆ Cemento antico CA7A	B ☆ Rovere cognac RC3Q
B ☆ Royal oak RS4B	B Grigio titanio GZ8T	B Oliva LV5T	B Cadaques CQ3Q		
A Bianco opaco B17A	B Giallo zafferano GZ8A	B Albicocca AB3C	B Orchidea OR7L	B Blu Egeo EG4L	

Vetri Glass

Ante Doors
WINDOW

Colori telaio
Frame colours

Trasparente TR9M	Trasparente fumé FT8P	Stop sol ST6P	Specchio SP7L	Alluminio AL1A	Titan grey TG7H
----------------------------	---------------------------------	-------------------------	-------------------------	--------------------------	---------------------------

Rovere white* Finitura unica per tutti i componenti in pannello presenti a listino non evidenziati con il colore Finiture GRUPPO 1 e/o Finiture GRUPPO 2.
Unique finish for all the panel components shown in the pricelist not highlighted with the color finishes GROUP 1 and/or finishes GROUP 2.

- A** Finiture in fascia di prezzo A
Finishes in price range A
- B** Finiture in fascia di prezzo B
Finishes in price range B
- ☆ Finiture con effetto materico
Finishes with textured effect

ARMADI CON ANTE BATTENTI E SCORREVOLI
WARDROBES WITH HINGED AND SLIDING DOORS

Armadi con ante battenti - H 225,6 P 56,3 Wardrobes with hinged doors - Ht 225.6 Dpt 56.3	pag. 56
Armadi con ante battenti - H 257,6 P 56,3 Wardrobes with hinged doors - Ht 257.6 Dpt 56.3	pag. 62
Armadi porta TV con ante battenti - P 56,3 TV wardrobes with hinged doors - Dpt 56.3	pag. 68
Elementi JOLLY JOLLY elements	pag. 69
Accessori per armadi con ante battenti Wardrobes with hinged doors accessories	pag. 70
Cabine ad angolo ELLE ELLE corner walk-in wardrobes	pag. 72
Cabine ad angolo ESSE ESSE corner walk-in wardrobes	pag. 74
Angoli interi per armadi - P 56,3 Corner wardrobes - Dpt 56.3	pag. 76
Terminali - P 56,3 End units - Dpt 56.3	pag. 77
Librerie terminali ORDER - L 32,5 P 54,5 - con contenitore L 30 P 32,5 ORDER end bookshelves - W 32.5 Dpt 54.5 - with cabinet W 30 Dpt 32.5	pag. 78
Librerie terminali OLA - L 30,7 P 53,6 OLA end bookshelves - W 30.7 Dpt 53.6	pag. 79
Armadi con ante scorrevoli - H 225,3 P 61,5 Wardrobes with sliding doors - Ht 225.3 Dpt 61.5	pag. 80
Armadi con ante scorrevoli - H 257,3 P 61,5 Wardrobes with sliding doors - Ht 257.3 Dpt 61.5	pag. 82
Accessori per armadi con ante scorrevoli Wardrobes with sliding doors accessories	pag. 84
Facce di tamponamento Filler strips	pag. 86
Sistema COMBY - H 44,7 P 46,5 COMBY system - Ht 44.7 Dpt 46.5	pag. 88

Armadi con ante battenti - H 225,6 P 56,3

Wardrobes with hinged doors - Ht 225.6 Dpt 56.3



- Sono compresi i ripiani interni indicati con il tratteggio.
- 1 tubo appendiabiti è situato in corrispondenza delle ante H 96 - 128 - 160 - 192.
- 2 tubi appendiabiti sono situati in corrispondenza delle ante H 224.
- Sono dotati di piedini regolabili.

- Inner shelves included, indicated by the dotted line.
- With Ht 96 - 128 - 160 - 192 doors 1 clothes hanging rail is included.
- With Ht 224 doors 2 clothes hanging rails are included.
- They are equipped with adjustable feet.

Fianco finale
End panel
H Ht 225,6
P Dpt 54,5
Sp Th 1,8

L
W 30

Specificare
cerniera Sx o Dx
Specify hinge
L or R

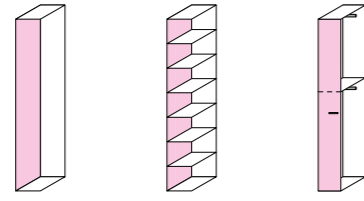

COD. VF00.90F VF00.91N VF00.92U

VOLO A B

WINDOW A B

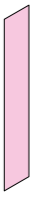

VF00.99Q

L
W 45

Specificare
cerniera Sx o Dx
Specify hinge
L or R

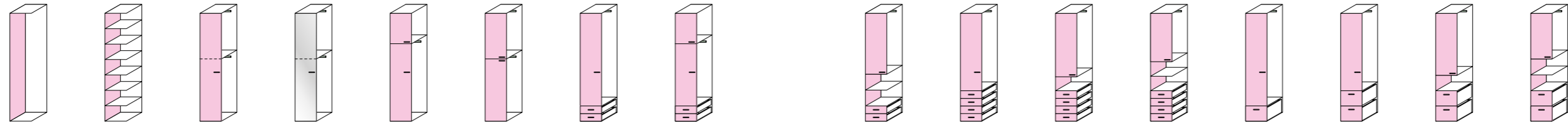

COD. VF00.00G VF00.01P VF00.02V VF00.93A VF00.03B VF00.04H VF00.05Q VF00.06W VF00.07C VF00.08K VF00.09R VF00.10N VF00.11U VF00.12A VF00.13G VF00.14P

VOLO A B

WINDOW A B

Anta specchio
Mirror door

L
W 60

Specificare
cerniera Sx o Dx
Specify hinge
L or R



COD. VF00.15V VF00.16B VF00.17H VF00.94G VF00.18Q VF00.19W VF00.20T VF00.21Z VF00.22F VF00.23N VF00.24U VF00.25A VF00.26G VF00.27P VF00.28V VF00.29B

VOLO A B

WINDOW A B

Anta specchio
Mirror door

L
W 90

Specificare
cerniera Sx o Dx
Specify hinge
L or R



COD. VF00.30Y VF00.31E VF00.32M VF00.95P VF00.33T VF00.34Z VF00.35F VF00.36N VF00.37U VF00.38A VF00.39G VF00.40D VF00.41L VF00.42S VF00.43Y VF00.44E

VOLO A B

WINDOW A B

Ante specchio
Mirror doors



pag. 40
pag. 70
pag. 77
pag. 86

Posizionamento pomelli e maniglie
Knobs and handles position
Accessori per armadi con ante battenti
Wardrobes with hinged doors accessories
Elementi terminali
End elements
Fasce di tamponamento
Filler strips

Armadi con ante battenti - H 225,6 P 56,3

Wardrobes with hinged doors - Ht 225.6 Dpt 56.3



- Sono compresi i ripiani interni indicati con il tratteggio.
- 1 tubo appendiabiti è situato in corrispondenza delle ante H 96 - 128 - 160 - 192.
- 2 tubi appendiabiti sono situati in corrispondenza delle ante H 224.
- Sono dotati di piedini regolabili.

- Inner shelves included, indicated by the dotted line.
- With Ht 96 - 128 - 160 - 192 doors 1 clothes hanging rail is included.
- With Ht 224 doors 2 clothes hanging rails are included.
- They are equipped with adjustable feet.

L
W 121,8

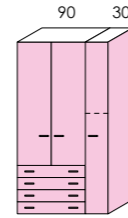
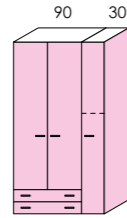
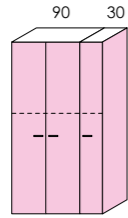

COD.	VF00.96V	VF00.97B	VF00.98H
VOLO	(A)	(B)	
WINDOW	(A)	(B)	

L
W 136,8

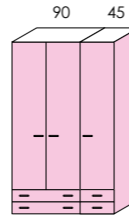
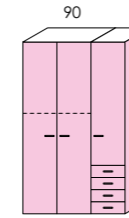
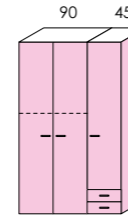
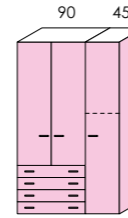
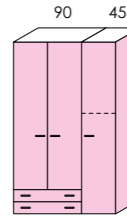
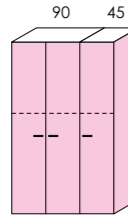

COD.	VF00.45M	VF00.46T	VF00.47Z	VF00.48F	VF00.49N	VF00.50K
VOLO	(A)	(B)				
WINDOW	(A)	(B)				

L
W 151,8

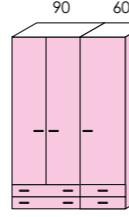
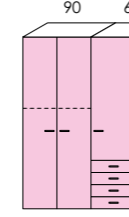
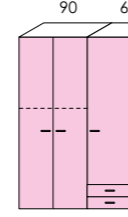
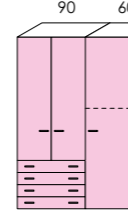
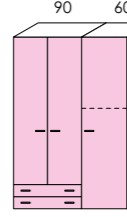
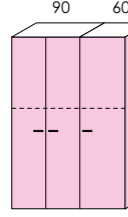

COD.	VF00.51R	VF00.52X	VF00.53D	VF00.54L	VF00.55S	VF00.56Y
VOLO	(A)	(B)				
WINDOW	(A)	(B)				

L
W 181,8

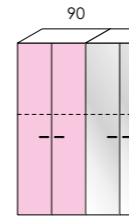
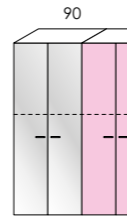
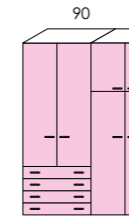
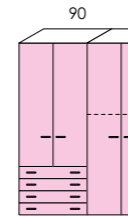
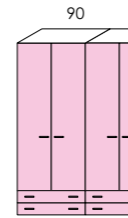
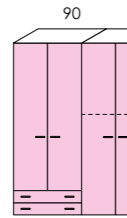
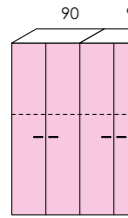

COD.	VF00.57E	VF00.58M	VF00.59T	VF00.60Q	VF00.61W	VF01.96Z	VF01.97F	VF01.98N
VOLO	(A)	(B)						
WINDOW	(A)	(B)						



pag. 40
pag. 70
pag. 77
pag. 86

Posizionamento pomelli e maniglie
Knobs and handles position
Accessori per armadi con ante battenti
Wardrobes with hinged doors accessories
Elementi terminali
End elements
Fasce di tamponamento
Filler strips

Armadi con ante battenti - H 225,6 P 56,3

Wardrobes with hinged doors - Ht 225.6 Dpt 56.3

- Sono compresi i ripiani interni indicati con il tratteggio.
- 1 tubo appendiabiti è situato in corrispondenza delle ante H 96 - 128 - 160 - 192.
- 2 tubi appendiabiti sono situati in corrispondenza delle ante H 224.
- Sono dotati di piedini regolabili.

- Inner shelves included, indicated by the dotted line.
- With Ht 96 - 128 - 160 - 192 doors 1 clothes hanging rail is included.
- With Ht 224 doors 2 clothes hanging rails are included.
- They are equipped with adjustable feet.

L
W 211,8

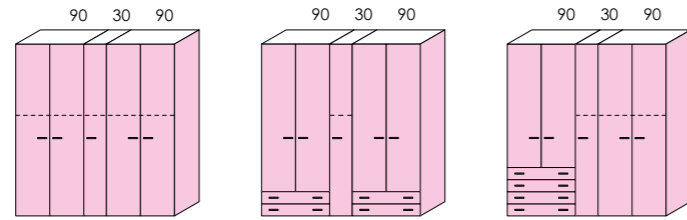

COD.	VF01.85N	VF01.86U	VF01.87A
VOLO	<input type="radio"/> A	<input type="radio"/> B	<input type="radio"/> B
WINDOW	<input type="radio"/> A	<input type="radio"/> B	<input type="radio"/> B

L
W 226,8

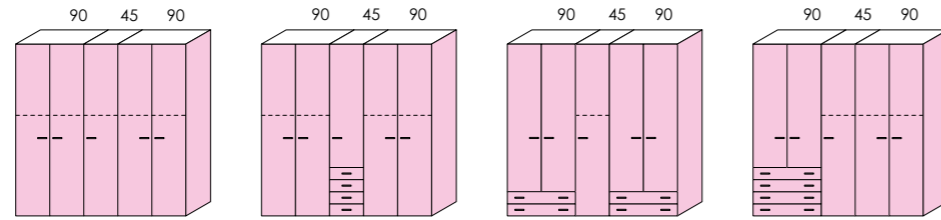

COD.	VF00.62C	VF00.63K	VF00.64R	VF00.65X
VOLO	<input type="radio"/> A	<input type="radio"/> B	<input type="radio"/> B	<input type="radio"/> B
WINDOW	<input type="radio"/> A	<input type="radio"/> B	<input type="radio"/> B	<input type="radio"/> B

L
W 241,8

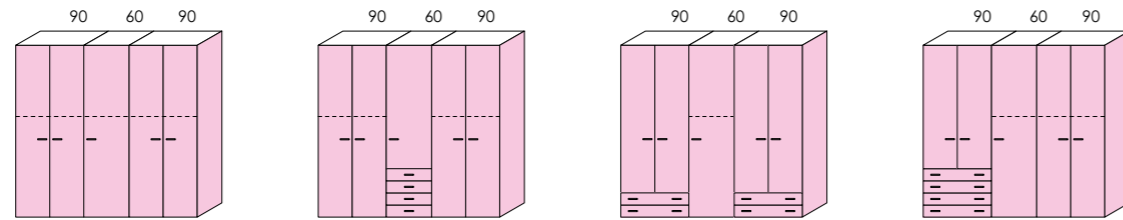

COD.	VF00.66D	VF00.67L	VF00.68S	VF00.69Y
VOLO	<input type="radio"/> A	<input type="radio"/> B	<input type="radio"/> B	<input type="radio"/> B
WINDOW	<input type="radio"/> A	<input type="radio"/> B	<input type="radio"/> B	<input type="radio"/> B

L
W 271,8

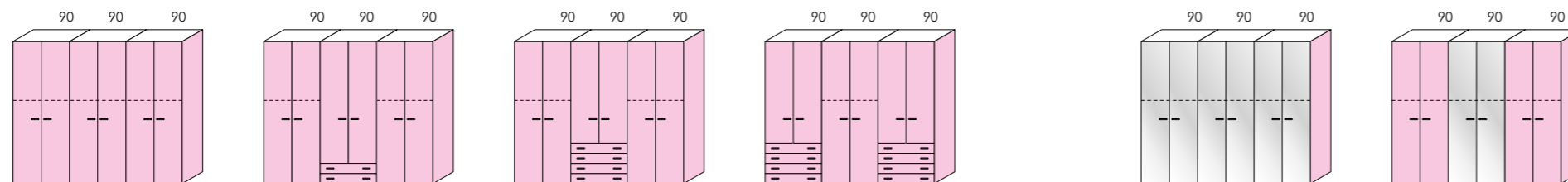

COD.	VF00.70V	VF00.71B	VF00.72H	VF00.73Q	VF01.88G	VF01.89P
VOLO	<input type="radio"/> A	<input type="radio"/> B	<input type="radio"/> B	<input type="radio"/> B	<input type="radio"/> B	<input type="radio"/> B
WINDOW	<input type="radio"/> A	<input type="radio"/> B	<input type="radio"/> B	<input type="radio"/> B	<input type="radio"/> B	<input type="radio"/> B



pag. 40
pag. 70
pag. 77
pag. 86

Posizionamento pomelli e maniglie
Knobs and handles position
Accessori per armadi con ante battenti
Wardrobes with hinged doors accessories
Elementi terminali
End elements
Fasce di tamponamento
Filler strips

Armadi con ante battenti - H 257,6 P 56,3

Wardrobes with hinged doors - Ht 257.6 Dpt 56.3



- Sono compresi i ripiani interni indicati con il tratteggio.
- 1 tubo appendiabiti è situato in corrispondenza delle ante H 96 - 128 - 160 - 192.
- 2 tubi appendiabiti sono situati in corrispondenza delle ante H 224 - 256.
- Sono dotati di piedini regolabili.

- Inner shelves included, indicated by the dotted line.
- With Ht 96 - 128 - 160 - 192 doors 1 clothes hanging rail is included.
- With Ht 224 - 256 doors 2 clothes hanging rails are included.
- They are equipped with adjustable feet.

Fianco finale

End panel
H Ht 257,6
P Dpt 54,5
Sp Th 1,8

L
W 30

Specificare
cerniera Sx o Dx
Specify hinge
L or R

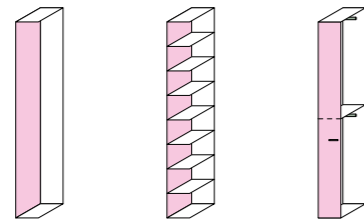

COD. VF01.90L VF01.91S VF01.92Y

VOLO (A) (B)

WINDOW (A) (B)

VF01.99U

L
W 45

Specificare
cerniera Sx o Dx
Specify hinge
L or R



COD. VF01.00M VF01.01T VF01.02Z VF01.93E VF01.03F VF01.04N VF01.05U VF01.06A VF01.07G VF01.08P VF01.09V VF01.10S VF01.11Y VF01.12E VF01.13M VF01.14T

VOLO (A) (B)

WINDOW (A) (B)

L
W 60

Specificare
cerniera Sx o Dx
Specify hinge
L or R

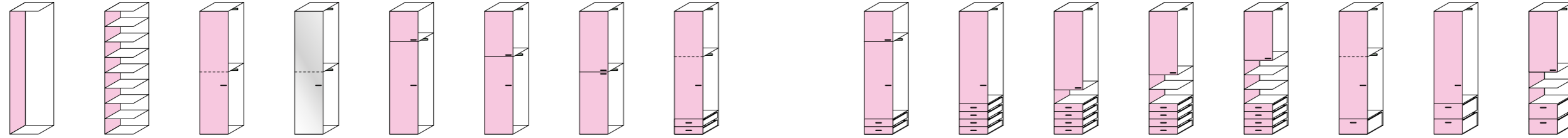

COD. VF01.15Z VF01.16F VF01.17N VF01.94M VF01.18U VF01.19A VF01.20X VF01.21D VF01.22L VF01.23S VF01.24Y VF01.25E VF01.26M VF01.27T VF01.28Z VF01.29F

VOLO (A) (B)

WINDOW (A) (B)

L
W 90

Specificare
cerniera Sx o Dx
Specify hinge
L or R

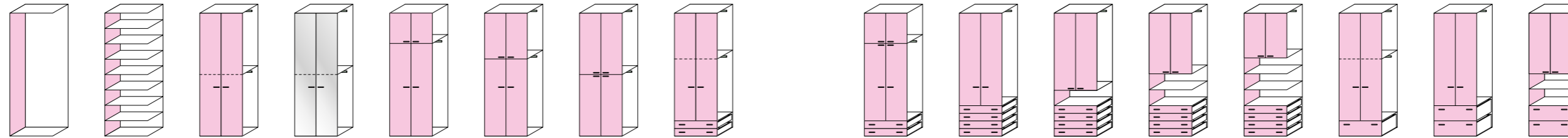

COD. VF01.30C VF01.31K VF01.32R VF01.95T VF01.33X VF01.34D VF01.35L VF01.36S VF01.37Y VF01.38E VF01.39M VF01.40H VF01.41Q VF01.42W VF01.43C VF01.44K

VOLO (A) (B)

WINDOW (A) (B)



pag. 40

Posizionamento pomelli e maniglie

Knobs and handles position

pag. 70 Accessori per armadi con ante battenti

Wardrobes with hinged doors accessories

pag. 77 Elementi terminali

End elements

pag. 86 Fasce di tamponamento

Filler strips

Armadi con ante
battenti e scorrevoli
Wardrobes with hinged
and sliding doors

Armadi con ante battenti - H 257,6 P 56,3

Wardrobes with hinged doors - Ht 257.6 Dpt 56.3



- Sono compresi i ripiani interni indicati con il tratteggio.
- 1 tubo appendiabiti è situato in corrispondenza delle ante H 96 - 128 - 160 - 192.
- 2 tubi appendiabiti sono situati in corrispondenza delle ante H 224 - 256.
- Sono dotati di piedini regolabili.

- Inner shelves included, indicated by the dotted line.
- With Ht 96 - 128 - 160 - 192 doors 1 clothes hanging rail is included.
- With Ht 224 - 256 doors 2 clothes hanging rails are included.
- They are equipped with adjustable feet.

L
W 121,8

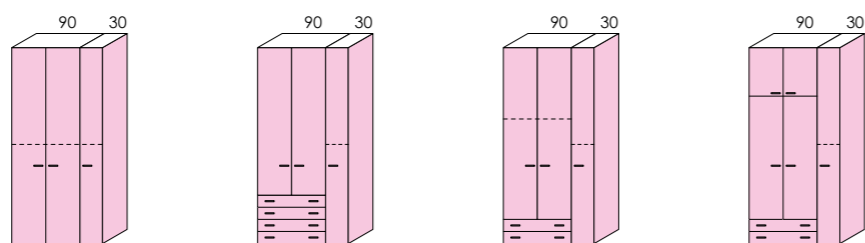

COD.	VF02.02D	VF02.03L	VF02.04S	VF02.05Y
VOLO	<input type="radio"/> A	<input type="radio"/> B	<input type="radio"/> A	<input type="radio"/> B
WINDOW	<input type="radio"/> A	<input type="radio"/> B	<input type="radio"/> A	<input type="radio"/> B

L
W 136,8

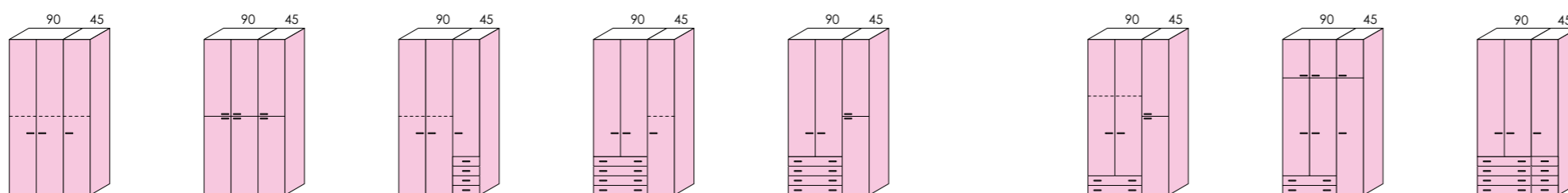

COD.	VF01.45R	VF01.46X	VF01.47D	VF01.48L	VF01.49S	VF01.50P	VF01.51V	VF01.52B
VOLO	<input type="radio"/> A	<input type="radio"/> B	<input type="radio"/> A	<input type="radio"/> B	<input type="radio"/> A	<input type="radio"/> B	<input type="radio"/> A	<input type="radio"/> B
WINDOW	<input type="radio"/> A	<input type="radio"/> B	<input type="radio"/> A	<input type="radio"/> B	<input type="radio"/> A	<input type="radio"/> B	<input type="radio"/> A	<input type="radio"/> B

L
W 151,8

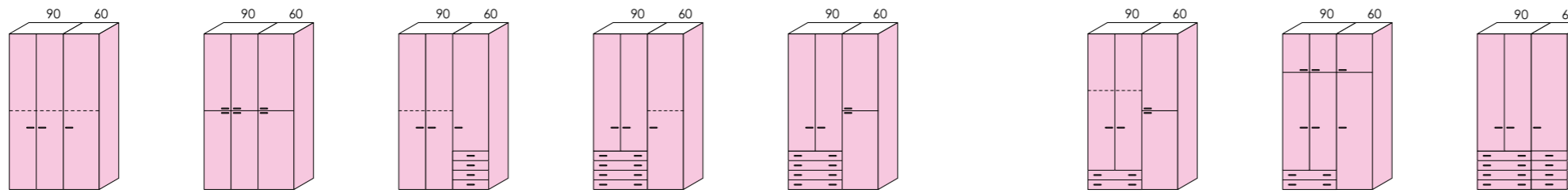

COD.	VF01.53H	VF01.54Q	VF01.55W	VF01.56C	VF01.57K	VF01.58R	VF01.59X	VF01.60U
VOLO	<input type="radio"/> A	<input type="radio"/> B	<input type="radio"/> A	<input type="radio"/> B	<input type="radio"/> A	<input type="radio"/> B	<input type="radio"/> A	<input type="radio"/> B
WINDOW	<input type="radio"/> A	<input type="radio"/> B	<input type="radio"/> A	<input type="radio"/> B	<input type="radio"/> A	<input type="radio"/> B	<input type="radio"/> A	<input type="radio"/> B

L
W 181,8

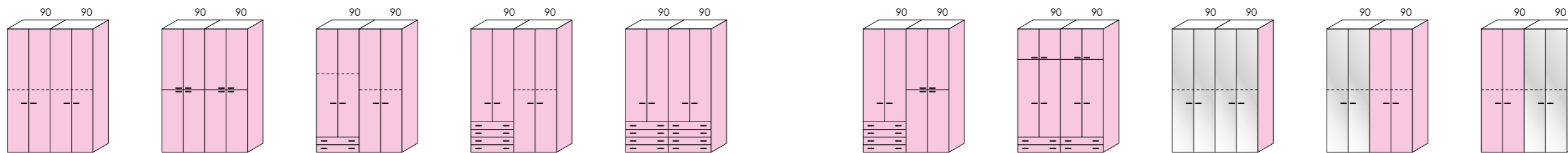

COD.	VF01.61A	VF01.62G	VF01.63P	VF01.64V	VF01.65B	VF01.66H	VF01.67Q	VF02.06E	VF02.07M	VF02.08T
VOLO	<input type="radio"/> A	<input type="radio"/> B	<input type="radio"/> A	<input type="radio"/> B	<input type="radio"/> A	<input type="radio"/> B	<input type="radio"/> A	<input type="radio"/> B	<input type="radio"/> A	<input type="radio"/> B
WINDOW	<input type="radio"/> A	<input type="radio"/> B	<input type="radio"/> A	<input type="radio"/> B	<input type="radio"/> A	<input type="radio"/> B	<input type="radio"/> A	<input type="radio"/> B	<input type="radio"/> A	<input type="radio"/> B



pag. 40
pag. 70
pag. 77
pag. 86

Posizionamento pomelli e maniglie
Knobs and handles position
Accessori per armadi con ante battenti
Wardrobes with hinged doors accessories
Elementi terminali
End elements
Fasce di tamponamento
Filler strips

Armadi con ante battenti - H 257,6 P 56,3

Wardrobes with hinged doors - Ht 257.6 Dpt 56.3

- Sono compresi i ripiani interni indicati con il tratteggio.
- 1 tubo appendiabiti è situato in corrispondenza delle ante H 96 - 128 - 160 - 192.
- 2 tubi appendiabiti sono situati in corrispondenza delle ante H 224 - 256.
- Sono dotati di piedini regolabili.

- Inner shelves included, indicated by the dotted line.
- With Ht 96 - 128 - 160 - 192 doors 1 clothes hanging rail is included.
- With Ht 224 - 256 doors 2 clothes hanging rails are included.
- They are equipped with adjustable feet.

L
W 211,8

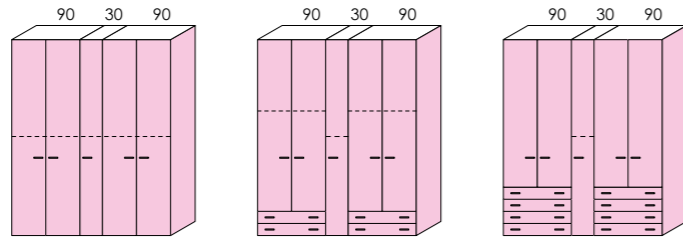

COD.	VF02.12K	VF02.13R	VF02.14X
VOLO	<input type="radio"/> A	<input type="radio"/> B	<input type="radio"/> B
WINDOW	<input type="radio"/> A	<input type="radio"/> B	<input type="radio"/> B

L
W 226,8

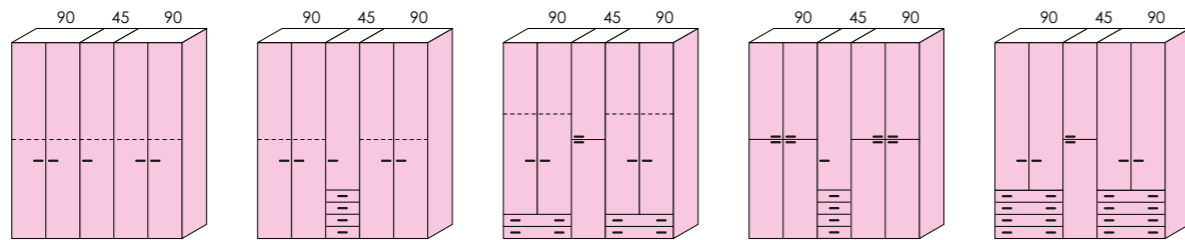

COD.	VF01.68W	VF01.69C	VF01.70Z	VF01.71F	VF01.72N
VOLO	<input type="radio"/> A	<input type="radio"/> B	<input type="radio"/> B	<input type="radio"/> B	<input type="radio"/> B
WINDOW	<input type="radio"/> A	<input type="radio"/> B	<input type="radio"/> B	<input type="radio"/> B	<input type="radio"/> B

L
W 241,8

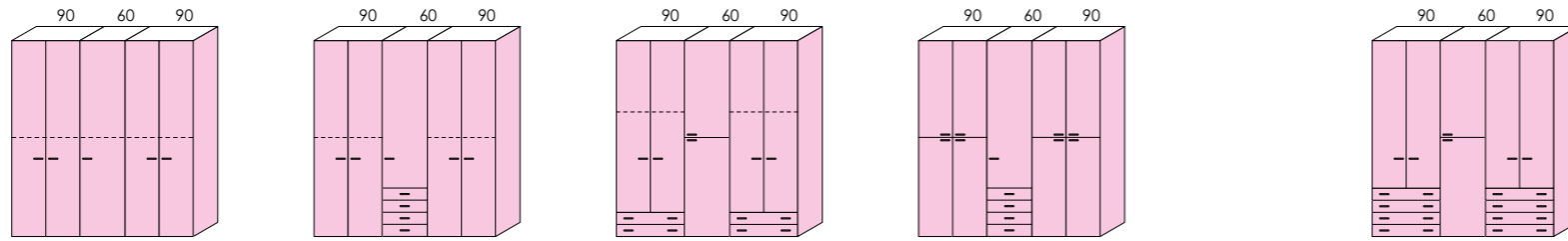

COD.	VF01.73U	VF01.74A	VF01.75G	VF01.76P	VF01.77V
VOLO	<input type="radio"/> A	<input type="radio"/> B	<input type="radio"/> B	<input type="radio"/> B	<input type="radio"/> B
WINDOW	<input type="radio"/> A	<input type="radio"/> B	<input type="radio"/> B	<input type="radio"/> B	<input type="radio"/> B

L
W 271,8

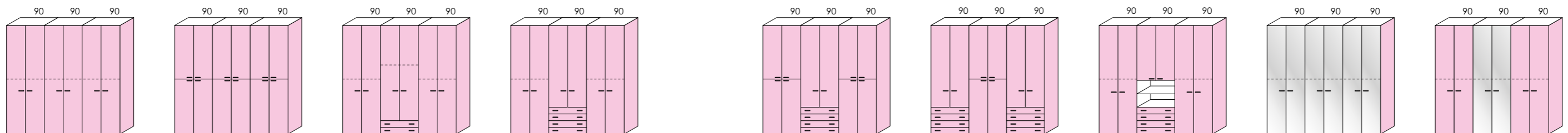

COD.	VF01.78B	VF01.79H	VF01.80E	VF01.81M	VF01.82T	VF01.83Z	VF01.84F	VF02.17S	VF02.18Y
VOLO	<input type="radio"/> A	<input type="radio"/> B	<input type="radio"/> B	<input type="radio"/> B	<input type="radio"/> B	<input type="radio"/> B	<input type="radio"/> B	<input type="radio"/> B	<input type="radio"/> B
WINDOW	<input type="radio"/> A	<input type="radio"/> B	<input type="radio"/> B	<input type="radio"/> B	<input type="radio"/> B	<input type="radio"/> B	<input type="radio"/> B	<input type="radio"/> B	<input type="radio"/> B



pag. 40
pag. 70
pag. 77
pag. 86

Posizionamento pomelli e maniglie
Knobs and handles position
Accessori per armadi con ante battenti
Wardrobes with hinged doors accessories
Elementi terminali
End elements
Fasce di tamponamento
Filler strips

Armadi porta TV con ante battenti - P 56,3

TV wardrobes with hinged doors - Dpt 56.3

- Sono compresi i ripiani interni indicati con il tratteggio.
- 1 tubo appendiabiti è situato in corrispondenza delle ante H 96.
- Sono dotati di piedini regolabili.

- Inner shelves included, indicated by the dotted line.
- With Ht 96 doors 1 clothes hanging rail is included.
- They are equipped with adjustable feet.

H
Ht 225,6

- * Specificare cerniera ante porta tv Sx o Dx (disegno Sx)
- Specify L or R tv door hinge (L drawing)

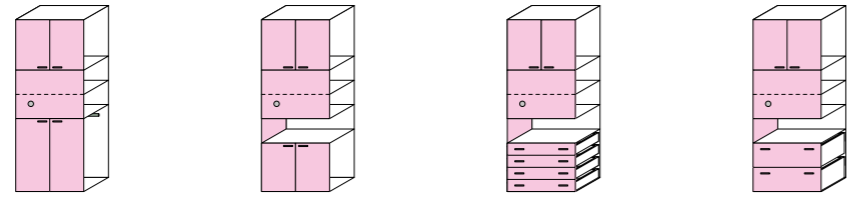

COD. VF02.70D VF02.71L VF02.72S VF02.73Y VF00.99Q

VOLO



Fianco finale
End panel
H Ht 225,6
P Dpt 54,5
Sp Th 1,8

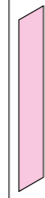

H
Ht 257,6

- * Specificare cerniera ante porta tv Sx o Dx (disegno Sx)
- Specify L or R tv door hinge (L drawing)

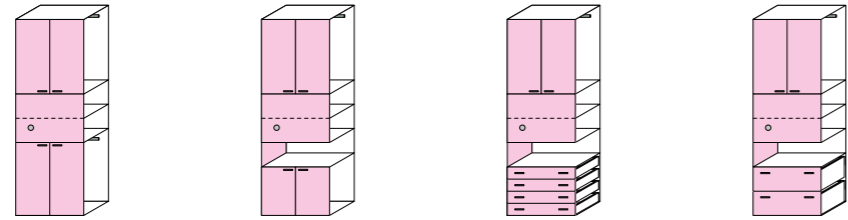

COD. VF02.74E VF02.75M VF02.76T VF02.77Z VF01.99U

VOLO



Fianco finale
End panel
H Ht 257,6
P Dpt 54,5
Sp Th 1,8

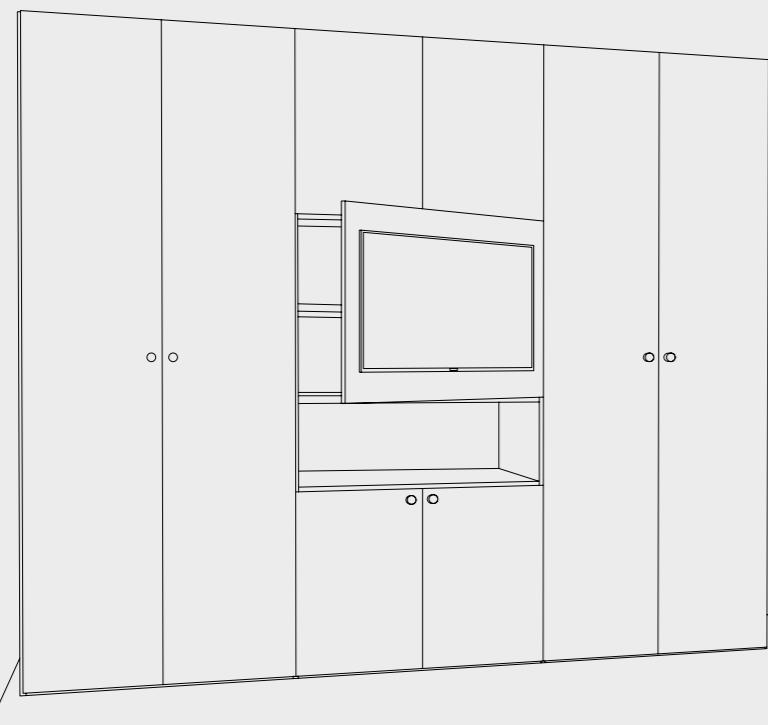
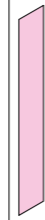

Dimensioni ante porta TV: L 89,7 - H 63,6 - Sp 1,8; portata massima 6 Kg.
L'ante porta tv è dotata di: apertura push-pull, foro passacavi e copriforo Ø 8.
Nelle versioni con vano a giorno è presente 1 copriforo per passacavi Ø 8 aggiuntivo, in modo da consentire il passaggio dei vari cablaggi dal vano a giorno al vano porta tv; il foro sul ripiano è a cura del cliente.

TV door dimension: L 89,7 - H 63,6 - Th 1,8; maximum load capacity 6 Kg.
The TV door is equipped with: push-pull opening, cable hole and hole cover Ø 8.
In the versions with open compartment there is an additional hole cover for Ø 8 cables, in order to allow the passage of the various wiring from the open compartment to the TV compartment; the hole on the shelf has to be made on site.

Elementi JOLLY

JOLLY elements

- Sono compresi i ripiani interni indicati con il tratteggio.

- Inner shelves included, indicated by the dotted line.

P
Dpt 45,8

H
Ht 225,6

- * Specificare cerniera Sx o Dx (disegno Sx)
- Specify hinge L or R (L drawing)

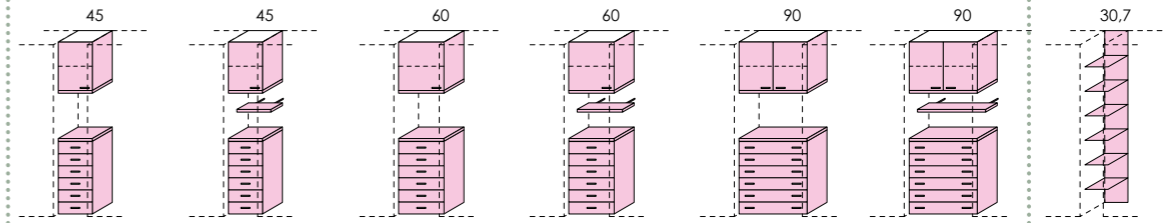

COD. VF00.80F * VF00.74W * VF00.82U * VF00.76K * VF00.84G VF00.78X VF00.86Q

VOLO



Configurazioni di elementi predefiniti da posizionare fra due Armadi.

Configurations of predefined elements to be placed between two Wardrobes.

In fase d'ordine, completare con il fianco finale l'armadio che precede gli elementi JOLLY.

When ordering, complete the wardrobe that precedes the JOLLY elements with the final side.

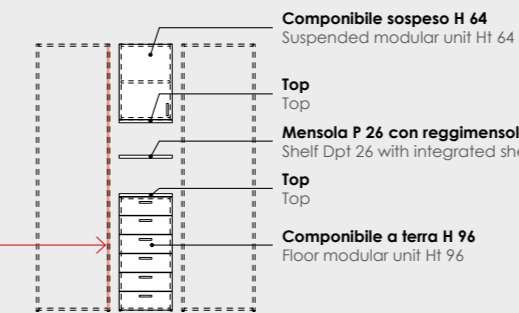

Componibile sospeso H 64
Suspended modular unit Ht 64

Top

Top

Mensole P 26 con reggimensola a scomparsa
Shelf Dpt 26 with integrated shelf holder

Top

Top

Componibile a terra H 96
Floor modular unit Ht 96

Pannello retro Sp 1,8
Back panel Th 1,8

Ripiani P 52,7 Sp 1,8
Shelves Dpt 52,7 Th 1,8

P
Dpt 45,8

H
Ht 257,6

- * Specificare cerniera Sx o Dx (disegno Sx)
- Specify hinge L or R (L drawing)

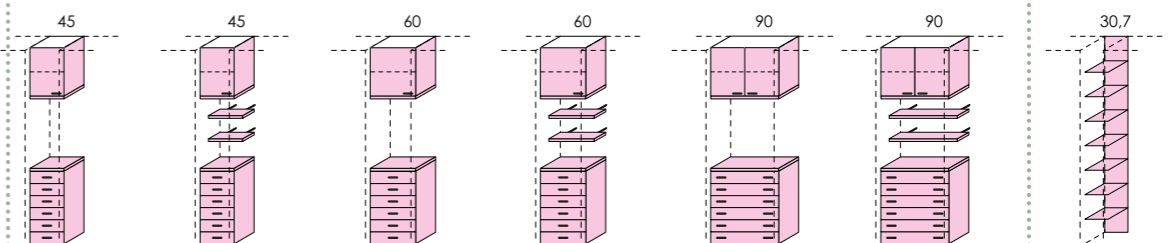

COD. VF00.81N * VF00.75C * VF00.83A * VF00.77R * VF00.85P VF00.79D VF00.87W

VOLO



Configurazioni di elementi predefiniti da posizionare fra due Armadi.

Configurations of predefined elements to be placed between two Wardrobes.

In fase d'ordine, completare con il fianco finale l'armadio che precede gli elementi JOLLY.

When ordering, complete the wardrobe that precedes the JOLLY elements with the final side.

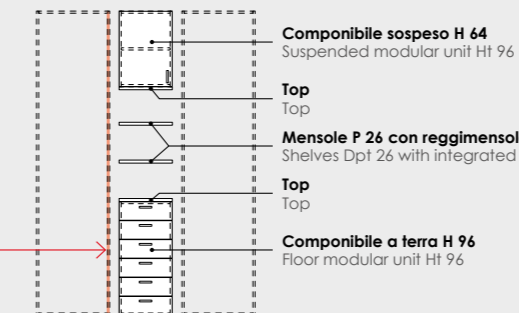

Componibile sospeso H 64
Suspended modular unit Ht 96

Top

Top

Mensole P 26 con reggimensola a scomparsa
Shelves Dpt 26 with integrated shelf holder

Top

Top

Componibile a terra H 96
Floor modular unit Ht 96

Pannello retro Sp 1,8
Back panel Th 1,8

Ripiani Sp 1,8
Shelves Th 1,8

pag. 40
pag. 70
pag. 77
pag. 86

Posizionamento pomelli e maniglie
Knobs and handles position
Accessori per armadi con ante battenti
Wardrobes with hinged doors accessories
Elementi terminali
End elements
Fasce di tamponamento
Filler strips

Accessori per armadi con ante battenti

Wardrobes with hinged doors accessories



	Ripiani interni Sp 2,5 Inner shelves Th 2.5		Ripiani interni Sp 3,5 Inner shelves Th 3.5		Tubi appendiabiti Clothes hanging rails		Cassettiere interne Inner chests of drawers		Divisorio interno Internal partition		Porta scarpe (piano inclinato) Shoe rack (inclined plane)	
	P Dpt 51,5	P Dpt 53	P Dpt 51,5	P Dpt 53	L W 28,1	L W 28,1	H Ht 36,3	H Ht 68,3	H Ht 22,5	H Ht 6,1	H Ht 6,1	H Ht 6,1
	L W -	L W 28,1	L W -	L W 28,1	L W 43,1	L W 43,1	P Dpt 45,8	P Dpt 45,8	P Dpt 45,8	P Dpt 45,8	P Dpt 54,5	P Dpt 54,5
	L W 43,1	L W 43,1	L W 43,1	L W 43,1	L W 58,1	L W 58,1	L W 43,1	L W 43,1	L W 43,1	L W 88,1	L W 88,1	L W 88,1
	L W 58,1	L W 58,1	L W 58,1	L W 58,1	L W 88,1	L W 88,1	L W 58,1	L W 58,1	L W 58,1	L W 88,1	L W 88,1	L W 88,1
	L W 88,1	L W 88,1	L W 88,1	L W 88,1	L W 88,1	L W 88,1	L W 88,1	L W 88,1	L W 88,1	L W 88,1	L W 88,1	L W 88,1
L	COD.		COD.		COD.		COD.		COD.		COD.	
W	-		VF31.02K		-		VF31.06L		-		-	
30	VF32.80U		VF32.83P		VF31.03R		VF32.86H		VF35.04Q		VF32.95G	
45	VF32.81A		VF32.84V		VF31.04X		VF32.87Q		VF35.06C		VF32.96P	
60	VF32.82G		VF32.85B		VF31.05D		VF32.88W		VF32.93U			
90												

ACCESSORI PER L 90 ACCESSORIES FOR W 90

Saliscendi per abiti Slide rail for clothes

H Ht 84

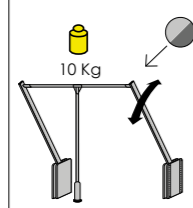

COD. VF32.89C

Porta pantaloni estraibile Pull-out trousers rack

H Ht 8
P Dpt 46,5
L W 85,5 ÷ 100

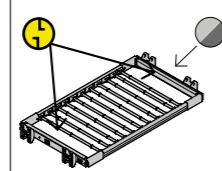

COD. VF32.90Z

Porta cravatte/cinture/ pantaloni estraibile Ties/belts holders and pull-out trousers rack

H Ht 8
P Dpt 46,5
L W 85,5 ÷ 100

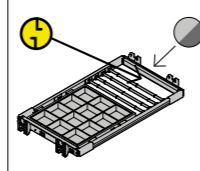

COD. VF32.91F

Porta scarpe estraibile Pull-out shoe rack

H Ht 17,2
P Dpt 46,5
L W 85,5 ÷ 100

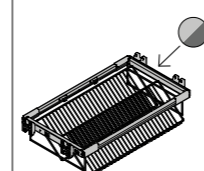

COD. VF32.92N

Cestello estraibile in metallo Metal pull-out basket

H Ht 12,4
P Dpt 46,5
L W 85,5 ÷ 100

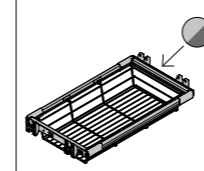

COD. VF33.01M

2 porta biancheria estraibili in tessuto 2 pull-out fabric laundry baskets

H Ht 41,5
P Dpt 46,5
L W 85,5 ÷ 100

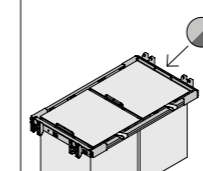

COD. VF33.02T

Ganci porta cravatte Tie rack hooks

L W 42

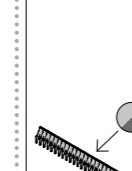

COD. VF33.03Z

Svuota tasche Coin tray

L W 42

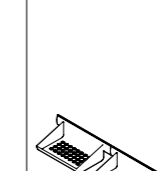

COD. VF33.04F

Inseribili dove è presente l'icona
Can be inserted where the icon is shown

Esempio di porta pantaloni con ganci porta cravatte e svuota tasche.
Example of pant rack with tie rack hooks and coin tray.

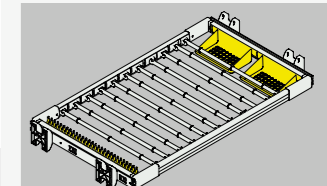

ACCESSORI COMUNI SHARED ACCESSORIES

Bastone prendi abito Reacher pole

H Ht 115

In metallo
Metal

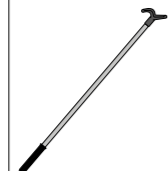

COD. VF32.97V

Appendi abiti scorrevole Sliding clothes rail

Consigliati per armadi ridotti in profondità:
P 40 = per profondità superiori a 40 cm.
P 24,5 = per profondità inferiori a 40 cm.
Recommended for wardrobes with small depth:
Dpt 40 = for depth greater than 40 cm.
Dpt 24,5 = for depth less than 40 cm.



COD. VF32.30S



COD. VF32.31Y

Porta cravatte Tie hanging rack

L W 35,2

Applicabile sull'interno dell'anta
Apply on inside of door

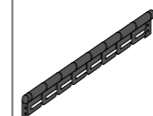

COD. VF32.98B

Appendi scarpe Hanging shoes rack

L W 45 ÷ 70

Applicabile sul fianco dell'armadio
Apply to the side of the wardrobe



COD. VF32.99H

Specchio interno Inner mirror

H Ht 120
L W 28



COD. VF33.00E

ACCESSORI COMUNI SHARED ACCESSORIES

Lampada led SPARK SPARK led lighting

Ø 9,1
Sp Th 4,4

Interruttore manuale o sensore di luce azionabile con interruttore laterale. Applicabile con le viti fornite o con velcro biadesivo. 3 batterie da 1,5v AAA non incluse.

Manual switch or light sensor that can be operated with the side switch. Applied with the provided screws or with biadhesive Velcro. 3 - 1.5v AAA batteries not included.



COD. VF32.59M

Lampada led SKY SKY led lighting

H Ht 2,2
P Dpt 1,5
L W 17

Interruttore touch integrato. Applicabile con le viti fornite o con biadesivo. 3 batterie da 1,5v AAA non incluse.

Built-in touch switch. Applied with the provided screws or with biadhesive tape. 3 - 1.5v AAA batteries not included.

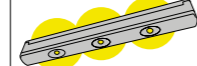

COD. VF32.60H

Lampada LED LED lamp

L W 15
P Dpt 6,5
H Ht 1,4

Dotata di batteria al litio integrata ricaricabile tramite cavo micro USB (non incluso). Applicabile con le viti fornite o con calamite adesive. Con sensore di presenza.

Equipped with integrated lithium battery rechargeable via micro USB cable (not included). Applied with the supplied screws or with adhesive magnets. With presence sensor.

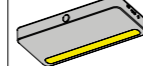

COD. VF32.58E

Lampada led SMARTY SMARTY led lamp

L W 40,5
P Dpt 4
H Ht 1

Dotata di batteria integrata ricaricabile tramite cavo USB (incluso). Si aggancia a due placche magnetiche applicabili con viti o biadesivo fornite. Con sensore di presenza.

Equipped with integrated battery rechargeable via USB cable (included). Attaches to two magnetic plates that can be applied with the screws or double-sided tape provided. With presence sensor.

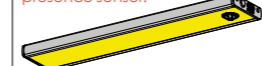

COD. VF34.99S

Illuminazione con sensore Lighting with sensor

L W 11,2
P Dpt 19,2
Sp Th 0,6

Kit completi di 1 alimentatore. Cover colore Alluminio e Titanio.
Complete kits with 1 Power pack. Cover color Aluminum and Titanium.

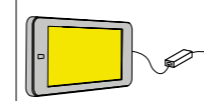

COD. VF32.63C

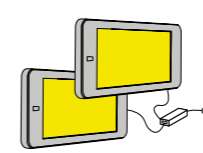

COD. VF32.64K

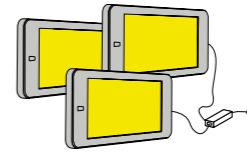

COD. VF32.65R

* Utilizzare solo come piano divisorio fra ante e fra ante e cassetti / cassettoni
Only for use as dividing surface between doors and between doors and drawers / big drawers



Cabine ad angolo ELLE

ELLE corner walk-in wardrobes

- Sono dotate di 2 ante L 45 fornite alla base di spazzolino ferma polvere.
- L'anta Sx è dotata di ferma polvere verticale.
- Sono prive di fondo.
- Sono dotate di piedini regolabili.

- They are equipped with 2 doors W 45 provided at the base with a dust-stop brush.
- L door is fitted with a vertical dust guard.
- They are bottomless.
- They are equipped with adjustable feet.

H
Ht 225,6

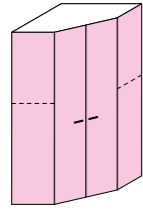

COD. VF02.15D

VOLO	A
	B
WINDOW	A
	B

H
Ht 257,6

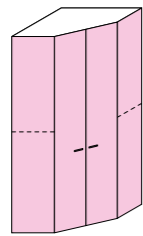

COD. VF02.16L

VOLO	A
	B
WINDOW	A
	B

Misure d'ingombro

Overall dimensions

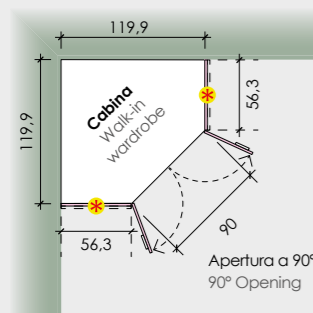

Attrezzatura interna

Internal equipment

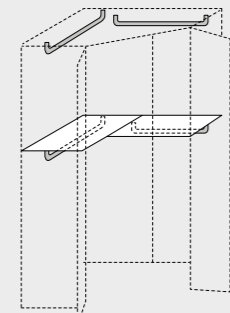

Esempi di utilizzo

Use example



⚠️ **DOPPIO FIANCO:** Gli armadi affiancati alla cabina ad angolo devono essere completi di fianco iniziale/finale.
DOUBLE SIDE PANEL: Wardrobes flanked by corner walk-in wardrobe must be complete with initial/end unit side panel.

È dotata di un Ripiano interno con appendiabiti, di un Tubo appendiabiti LUNGO e di uno CORTO.
Walk-in wardrobe is fitted with a inner shelf with Clothes hanging rail, with a LONG clothes hanging rail and with a SHORT one.

Gli armadi L 30/45/60 affiancati alla cabina ad angolo, devono avere le cerniere rivolte verso la cabina. Non è possibile posizionare un letto, un divano o altri elementi con profondità superiore a 56,3 accanto ad una cabina ad angolo.
IMPORTANTI! Consigliamo l'utilizzo della cabina ad angolo affiancata, su entrambi i lati, ad un armadio o un altro elemento che contribuisca alla sua stabilità.
IMPORTANTI! We recommend that the corner walk-in wardrobe is, on both sides, supported by a wardrobe or another element that will contribute to its stability.

W 30/45/60 wardrobes flanked by corner walk-in wardrobe must have their hinges in the direction of the walk-in wardrobe. It is not possible to place a bed, a sofa or other items more than 56.3 beside a corner walk-in wardrobe.

IMPORTANTI! We recommend that the corner walk-in wardrobe is, on both sides, supported by a wardrobe or another element that will contribute to its stability.



Ripiani interni mobili Sp 2,5

Movable inner shelves Th 2,5

LUNGO LONG

P Dpt 41,7

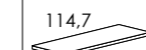

ANGOLO CORNER

P Dpt 41,7



LUNGO con appendiabiti LONG with clothes hanging rail

P Dpt 41,7

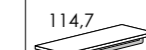

ANGOLO con appendiabiti CORNER with clothes hanging rail

P Dpt 41,7



COD. VF33.05N

COD. VF33.06U

COD. VF33.07A

COD. VF33.08G

Ripiani interni mobili Sp 3,5

Movable inner shelves Th 3,5

LUNGO LONG

P Dpt 41,7

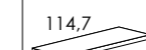

ANGOLO CORNER

P Dpt 41,7



LUNGO con appendiabiti LONG with clothes hanging rail

P Dpt 41,7

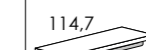

ANGOLO con appendiabiti CORNER with clothes hanging rail

P Dpt 41,7



COD. VF31.10B

COD. VF31.11H

COD. VF31.12Q

COD. VF31.13W

Tubi appendiabiti

Clothes hanging rails

In fase d'ordine specificare se per ripiani Sp 2,5 o 3,5
When ordering, specify whether for Th 2,5 or 3,5 shelves

LUNGO LONG

L W 108,7



CORTO SHORT

L W 70



COD. VF33.09P

COD. VF33.10L

Bastone prendi abito

Reacher pole

H Ht 115

In metallo Metal

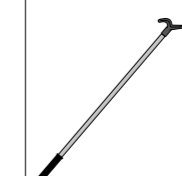

COD. VF32.97V

Specchio interno

Inner mirror

L W 28
H Ht 120



COD. VF33.00E

Appendi scarpe

Hanging shoes rack

L W 45 ÷ 70

Applicabile sul fianco dell'armadio
Apply to the side of the wardrobe



COD. VF32.99H

Lampada LED

LED lamp

L W 15
P Dpt 6,5
H Ht 1,4

Dotata di batteria al litio integrata ricaricabile tramite cavo micro USB (non incluso). Applicabile con le viti fornite o con calamite adesive. Con sensore di presenza.
Equipped with integrated lithium battery rechargeable via micro USB cable (not included). Applied with the supplied screws or with adhesive magnets. With presence sensor.



COD. VF32.58E

Illuminazione con sensore

Lighting with sensor

L W 11,2
P Dpt 19,2
Sp Th 0,6

Kit completo di 1 alimentatore. Cover colore Alluminio e Titanio.
Complete kits with 1 Power pack. Cover color Aluminum and Titanium.

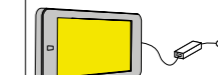

COD. VF32.63C

Lampada led SMARTY

SMARTY led lamp

L W 40,5
P Dpt 4
H Ht 1

Dotata di batteria integrata ricaricabile tramite cavo USB (incluso). Si aggancia a due placche magnetiche applicabili con viti o biadesivo forniti. Con sensore di presenza.
Equipped with integrated battery rechargeable via USB cable (included). Attaches to two magnetic plates that can be applied with the screws or double-sided tape provided. With presence sensor.



COD. VF34.99S

Accessori
Accessories

pag. 40
pag. 77

Posizionamento pomelli e maniglie
Knobs and handles position
Elementi terminali
End elements

Armadi con ante battenti e scorrevoli
Wardrobes with hinged and sliding doors

Cabine ad angolo ESSE

ESSE corner walk-in wardrobes

- Sono dotate di un'anta L 60 fornita alla base di spazzolino ferma polvere.
- Sono prive di fondo.
- Sono dotate di piedini regolabili.

- They are equipped with W 60 door provided at the base with a dust-stop brush.
- They are bottomless.
- They are equipped with adjustable feet.

H
Ht **225,6**

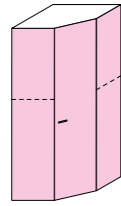

Specificare Sx o Dx
(disegno Dx)
Specify L or R
(drawings R)

COD. VF02.10W

VOLO A B

WINDOW A B

H
Ht **257,6**

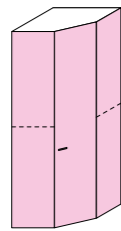

Specificare Sx o Dx
(disegno Dx)
Specify L or R
(drawings R)

COD. VF02.11C

VOLO A B

WINDOW A B

Misure d'ingombro

Overall dimensions

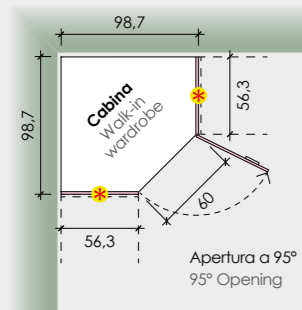

Attrezzatura interna

Internal equipment

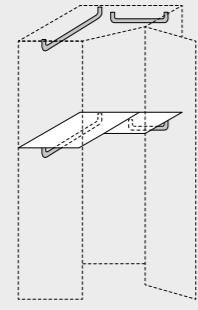

Esempi di utilizzo

Use example

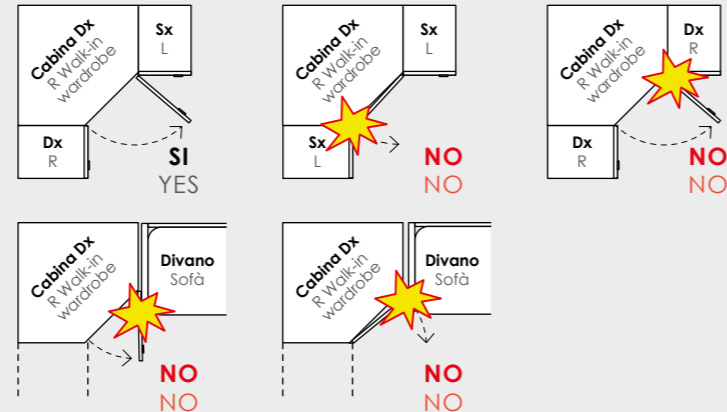

DOPPIO FIANCO: Gli armadi affiancati alla cabina ad angolo devono essere completi di fianco iniziale/fianco.

DOUBLE SIDE PANEL: Wardrobes flanked by corner walk-in wardrobe must be complete with initial/end unit side panel.

È dotata di un Ripiano interno con appendiabiti, di un Tubo appendiabiti LUNGO e di uno CORTO.

Walk-in wardrobe is fitted with a inner shelf with Clothes hanging rail, with a LONG clothes hanging rail and with a SHORT one.

Gli armadi L 30/45/60 affiancati alla cabina ad angolo, devono avere le cerniere rivolte verso la cabina. Non è possibile posizionare un letto, un divano o altri elementi con profondità superiore a 56,3 accanto ad una cabina ad angolo.

W 30/45/60 wardrobes flanked by corner walk-in wardrobe must have their hinges in the direction of the walk-in wardrobe. It is not possible to place a bed, a sofa or other items more than Dpt 56.3 beside a corner walk-in wardrobe.

Ripiani interni mobili Sp 2,5

Movable inner shelves Th 2,5

LUNGO
LONG

P Dpt 41,7

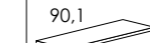

ANGOLO
CORNER

P Dpt 41,7

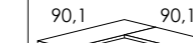

LUNGO con appendiabiti
LONG with clothes hanging rail

P Dpt 41,7

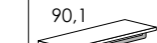

ANGOLO con appendiabiti
CORNER with clothes hanging rail

P Dpt 41,7



COD. VF34.28X

COD. VF34.29D

COD. VF34.30A

COD. VF34.31G

Ripiani interni mobili Sp 3,5

Movable inner shelves Th 3,5

LUNGO
LONG

P Dpt 41,7

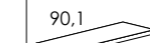

ANGOLO
CORNER

P Dpt 41,7

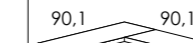

LUNGO con appendiabiti
LONG with clothes hanging rail

P Dpt 41,7

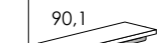

ANGOLO con appendiabiti
CORNER with clothes hanging rail

P Dpt 41,7



COD. VF31.14C

COD. VF31.15K

COD. VF31.16R

COD. VF31.17X

Tubi appendiabiti

Clothes hanging rails

In fase d'ordine specificare se per ripiani Sp 2,5 o 3,5
When ordering, specify whether for Th 2,5 or 3,5 shelves

LUNGO
LONG

L W 77,5



CORTO
SHORT

L W 47,8



COD. VF34.32P

COD. VF34.33V

Bastone prendi abito

Reacher pole

H Ht 115

In metallo
Metal

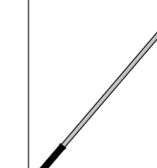

COD. VF32.97V

Specchio interno

Inner mirror

L W 28

H Ht 120



COD. VF33.00E

Appendi scarpe

Hanging shoes rack

L W 45 ÷ 70

Applicabile sul fianco dell'armadio
Apply to the side of the wardrobe



COD. VF32.99H

Lampada LED

LED lamp

L W 15
P Dpt 6,5
H Ht 1,4

Dotata di batteria al litio integrata ricaricabile tramite cavo micro USB (non incluso). Applicabile con le viti fornite o con calamite adesive. Con sensore di presenza.
Equipped with integrated lithium battery rechargeable via micro USB cable (not included). Applied with the supplied screws or with adhesive magnets. With presence sensor.

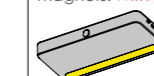

COD. VF32.58E

Illuminazione con sensore

Lighting with sensor

L W 11,2
P Dpt 19,2
Sp Th 0,6

Kit completo di 1 alimentatore. Cover colore Alluminio e Titanio.
Complete kits with 1 Power pack. Cover color Aluminum and Titanium.



COD. VF32.63C

Lampada led SMARTY

SMARTY led lamp

L W 40,5
P Dpt 4
H Ht 1

Dotata di batteria integrata ricaricabile tramite cavo USB (incluso). Si aggancia a due placche magnetiche applicabili con viti o biadesivo fornito. Con sensore di presenza.
Equipped with integrated battery rechargeable via USB cable (included). Attaches to two magnetic plates that can be applied with the screws or double-sided tape provided. With presence sensor.

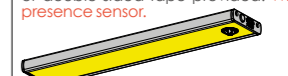

COD. VF34.99S

Accessori
Accessories

pag. 40
pag. 77

Posizionamento pomelli e maniglie
Knobs and handles position
Elementi terminali
End elements

Armadi con ante
battenti e scorrevoli
Wardrobes with hinged
and sliding doors

Angoli interi per armadi - P 56,3

Corner wardrobes - Dpt 56.3

- Non è possibile invertire gli ingombri. La maniglia è sempre posizionata sull'anta Dx.
- Rallentatori chiusura anta non previsti.
- Sono compresi i ripiani interni indicati con il tratteggio e 2 tubi appendiabiti.
- Sono dotati di piedini regolabili.

- Dimensions cannot be reversed. The handle is always fitted on the R door.
- Door closing retainers not provided.
- Inner shelves indicated by the dotted line and 2 clothes hanging rails included.
- They are equipped with adjustable feet.

H
Ht **225,6**

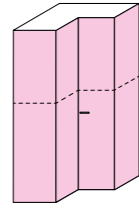

COD. **VF02.00R**

VOLO A
B

H
Ht **257,6**

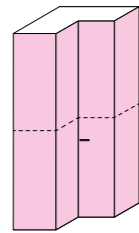

COD. **VF02.01X**

VOLO A
B

Misure d'ingombro

Overall dimensions

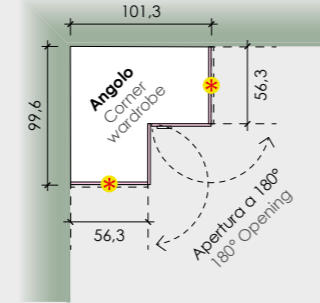

DOPPIO FIANCO: Gli armadi affiancati all'angolo ad angolo devono essere completi di fianco iniziale/finale.
DOUBLE SIDE PANEL: Wardrobes flanked by corner wardrobe must be complete with initial/end unit side panel.

Esempi di utilizzo

Use example

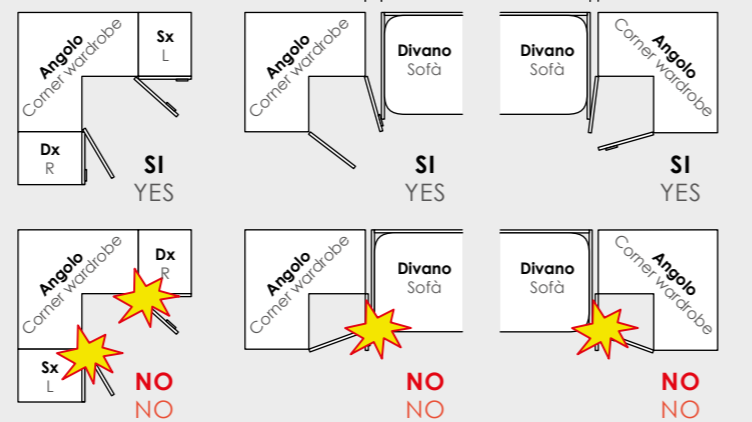

Per la totale apertura delle ante si consiglia di affiancare all'angolo elementi L 30/45/60 con cerniere rivolte verso l'angolo e/o elementi L 90 sprovvisti di cassetti.
Per il posizionamento di elementi di profondità superiore a 56,3 (es. letto, divano, etc.) accanto ad un angolo intero, rispettare le distanze minime indicate.

So as to be able to open the doors fully we recommend placing W 30/45/60 elements in the corner with the hinges facing the corner itself and/or W 90 elements without drawers.
For the positioning of elements that are of greater depth than 56,3 (bed, sofa, etc.) alongside corner wardrobe must respect the minimum distances indicated above.

Terminali - P 56,3

End units - Dpt 56.3

- Vanno sempre affiancati ad un armadio.
- Montano ante con cerniere 30° e basette dedicate.
- Sono compresi i ripiani interni indicati con il tratteggio.
- Non è possibile montare il tubo appendiabiti.
- Sono dotati di piedini regolabili.

- They always go side by side to a wardrobe.
- Fitted with doors with 30° opening hinges with mounting plates.
- Inner shelves included, indicated by the dotted line.
- Clothes hanging rail cannot be installed inside end units.
- They are equipped with adjustable feet.

Sx L
L W **38,8**

Dx R
L W **40,6**

H
Ht **225,6**

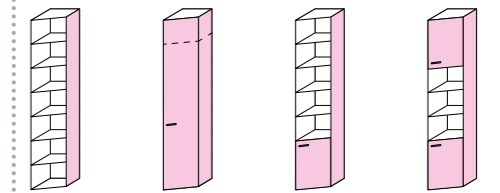
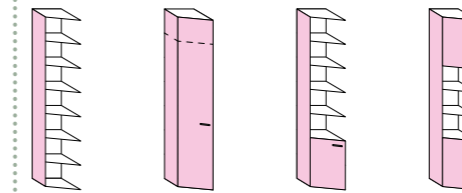

COD. **VF02.20B VF02.21H VF02.22Q VF02.23W**

COD. **VF02.24C VF02.25K VF02.26R VF02.27X**

VOLO A
B
WINDOW A
B

H
Ht **257,6**

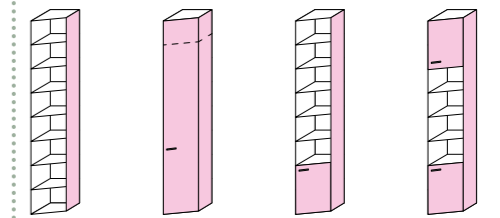
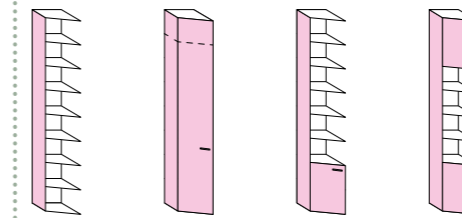

COD. **VF02.28D VF02.29L VF02.30G VF02.31P**

COD. **VF02.32V VF02.33B VF02.34H VF02.35Q**

VOLO A
B
WINDOW A
B

Misure d'ingombro

Overall dimensions

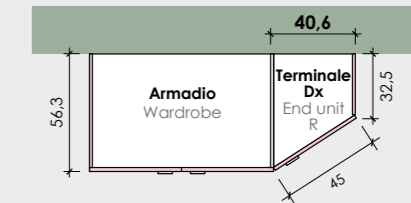
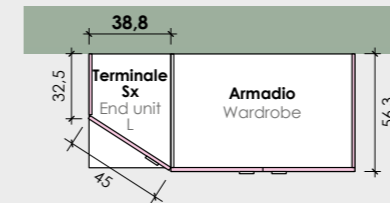

Accessori

Accessories

Ripiano interno Sp 2,5
Inner shelf Th 2.5
P Dpt 51,5

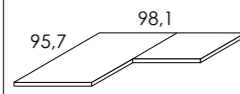

COD. **VF34.34B**

Ripiano interno Sp 3,5
Inner shelf Th 3.5
P Dpt 51,5

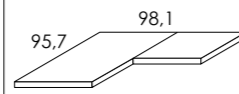

COD. **VF31.18D**

Tubo appendiabiti
Clothes hanging rail
L W 60

In fase d'ordine specificare se per ripiani Sp 2,5 o 3,5
When ordering, specify whether for Th 2.5 or 3.5 shelves

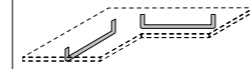

COD. **VF34.35H**

Bastone prendi abito
Reacher pole
H Ht 115

In metallo
Metal



COD. **VF32.97V**

Specchio interno
Inner mirror
L W 28
H Ht 120



COD. **VF33.00E**

Appendi scarpe
Hanging shoes rack
L W 45 ÷ 70

Applicabile sul fianco dell'armadio
Apply to the side of the wardrobe



COD. **VF32.99H**

ALTA

Accessori

Accessories

Ripiani per Terminali Sp 2,5
Shelves for End units Th 2.5
L W 37
P Dpt 53



COD. **VF34.36Q**

Ripiani per Terminali Sp 3,5
Shelves for End units Th 3.5
L W 37
P Dpt 53



COD. **VF34.37W**

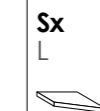

COD. **VF31.19L**



COD. **VF31.20G**

Librerie terminali ORDER - L 32,5 P 54,5 - con contenitore L 30 P 32,5
 ORDER end bookshelves - W 32.5 Dpt 54.5 - with cabinet W 30 Dpt 32.5

- Sono compresi ripiani interni ogni 32 cm.
- Sono dotate di piedini regolabili.
- Per garantire la stabilità sono necessarie 4 mensole sagomate equidistanti.

- Includes inner shelves every 32 cm.
- They are equipped with adjustable feet.
- To ensure the stability 4 equally-spaced shaped shelves must be inserted.

	Sx L				Dx R			
H_{Ht} 225,6								
COD.	VF02.50T	VF02.51Z	VF02.52F	VF02.53N	VF02.54U	VF02.55A	VF02.56G	VF02.57P
VOLO	(A)	(B)						
H_{Ht} 257,6								
COD.	VF02.58V	VF02.59B	VF02.60Y	VF02.61E	VF02.62M	VF02.63T	VF02.64Z	VF02.65F
VOLO	(A)	(B)						

Librerie terminali OLA - L 30,7 P 53,6
 OLA end bookshelves - W 30.7 Dpt 53.6

- Per garantire la stabilità sono necessarie 4 mensole sagomate equidistanti.
- Sono dotate di piedini regolabili.

- To ensure the stability 4 equally-spaced shaped shelves must be inserted.
- They are equipped with adjustable feet.

	Sx L		Dx R	
H_{Ht} 225,6				
COD.	VF02.40N	VF02.41U	VF02.42A	VF02.43G
VOLO	(A)	(B)		
H_{Ht} 257,6				
COD.	VF02.44P	VF02.45V	VF02.46B	VF02.47H
VOLO	(A)	(B)		

Accessori	Mensola ORDER	BOLLINO	PLUS	Specchio	Specchio
	ORDER shelf			Mirror	Mirror
	L W 24,4 P Dpt 30,6 Sp Th 2,5	Ø 10 P Dpt 4	L W 4,3 P Dpt 3 H Ht 6,5	Ø 30	L W 28 H Ht 120 * abbinabile matched
COD.	VF34.38C	VF32.61Q	VF32.62W	VF34.39K	VF33.00E
VOLO	(A)	(B)			

Accessori	Mensola OLA	BOLLINO	PLUS	Specchio	Specchio
	OLA shelf			Mirror	Mirror
	L W 51,8 P Dpt 29 Sp Th 2,5	Ø 10 P Dpt 4	L W 4,3 P Dpt 3 H Ht 6,5	Ø 30	L W 28 H Ht 120 * abbinabile matched
COD.	VF34.40F	VF32.61Q	VF32.62W	VF34.39K	VF33.00E
VOLO	(A)	(B)			

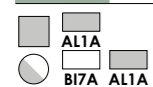

Armadi con ante scorrevoli - H 225,3 P 61,5

Wardrobes with sliding doors - Ht 225.3 Dpt 61.5

- Sono compresi i ripiani interni indicati con il tratteggio.
- Sono dotati di 2 tubi appendiabiti per vano.
- Sono dotati di piedini regolabili e parapolvere superiore sull'anta sporgente.
- Lo specchio Sp 0,4 è applicato su un pannello in nobilitato Sp 1,4.

- Inner shelves included, indicated by the dotted line.
- Each compartment is equipped with 2 clothes hanging rails.
- They are equipped with adjustable feet and upper dust-cover on external door.
- Th 0.4 mirror is applied on a Th 1.4 melamine panel.

	L 178,7 W				L 267,5 W			
	Indicare anta sporgente Dx o Sx Indicate whether projecting door is R or L							
FREE								
COD.	VF03.00V	VF03.01B	VF03.02H	VF03.24G	VF03.03Q	VF03.04W	VF03.25P	VF03.26V
	(A)							
	(B)							
MONDRIAN								
COD.	VF03.05C	VF03.06K	VF03.07R	VF03.08X	VF03.09D	VF03.27B		
	(A)							
	(B)							
SPLIT								
COD.	VF03.32Z	VF03.33F	VF03.34N	VF03.35U	VF03.36A	VF03.37G		
	(A)							
	(B)							
STRAPPO								
COD.	VF03.20F			VF03.21N				
	(A)							
	(B)							

Schema apertura ante scorrevoli

Opening diagram for sliding doors

Non è possibile invertire il verso di apertura.
The opening direction cannot be inverted.

178,7 (2 ante)
(2 doors)

267,5 (3 ante)
(3 doors)

Profilo maniglia:
Handle groove strip:

Colori disponibili:
Available colors:

RW3Q	RG9L	CB6K	RC3Q
RS4B	GZ8T	AL1A	BI7A

MONDRIAN

Esempio:
Example:

È possibile personalizzare le facciate dell'armadio specificando i colori desiderati per ogni quadrotto. Per il corretto posizionamento dei quadrotti è indispensabile inviare un disegno dell'armadio.

Wardrobe fronts can be customised by specifying the colours required for each square panel. For correct positioning of the square panels, it is essential to send a drawing of the wardrobe.

STRAPPO

Esempio:
Example:

L'anta laterale Dx dell'armadio ha un riperto laccato, in pannello di MDF Sp 0,4, applicato in posizione prestabilita (vedi soluzioni proposte). N.B. Il colore scelto per il riperto STRAPPO determinerà automaticamente anche la finitura delle ante scorrevoli sprovviste di riperto.

The R side door of the wardrobe has a lacquered MDF insert panel Th 0.4 applied in a pre-established position (see proposed solutions in the catalogue). N.B. The colour chosen for the STRAPPO insert panel will automatically determine the finish for the sliding doors without the insert panel.

- SP7L
- GL4R
- BI7A
- GZ8T
- LV5T
- CQ3QGZ8A
- AB3C
- OR7L
- EG4L

- pag. 77 Elementi terminali
- pag. 84 End elements
- pag. 86 Accessori per armadi con ante scorrevoli
- Wardrobes with sliding doors accessories
- Fasce di tamponamento
- Filler strips

Armadi con ante scorrevoli - H 257,3 P 61,5

Wardrobes with sliding doors - Ht 257.3 Dpt 61.5

- Sono compresi i ripiani interni indicati con il tratteggio.
- Sono dotati di 2 tubi appendiabiti per vano.
- Sono dotati di piedini regolabili e parapolvere superiore sull'anta sporgente.
- Lo specchio Sp 0,4 è applicato su un pannello in nobilitato Sp 1,4.

- Inner shelves included, indicated by the dotted line.
- Each compartment is equipped with 2 clothes hanging rails.
- They are equipped with adjustable feet and upper dust-cover on external door.
- Th 0.4 mirror is applied on a Th 1.4 melamine panel.

	L 178,7 W				L 267,5 W			
	Indicare anta sporgente Dx o Sx Indicate whether projecting door is R or L							
FREE								
COD.	VF03.10A	VF03.11G	VF03.12P	VF03.28H	VF03.13V	VF03.14B	VF03.29Q	VF03.30M
	(A)							
	(B)							
MONDRIAN								
COD.	VF03.15H	VF03.16Q	VF03.17W	VF03.18C	VF03.19K	VF03.31T		
	(A)							
	(B)							
SPLIT								
COD.	VF03.38P	VF03.39V	VF03.40S	VF03.41Y	VF03.42E	VF03.43M		
	(A)							
	(B)							
STRAPPO								
COD.	VF03.22U	VF03.23A						
	(A)							
	(B)							

Schema apertura ante scorrevoli

Opening diagram for sliding doors

Non è possibile invertire il verso di apertura.
The opening direction cannot be inverted.

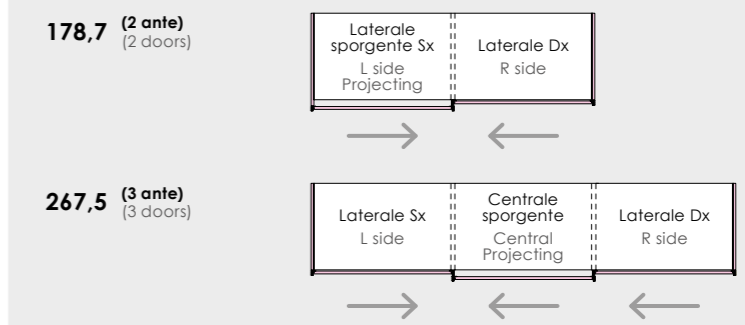

Profilo maniglia:

Handle groove strip:

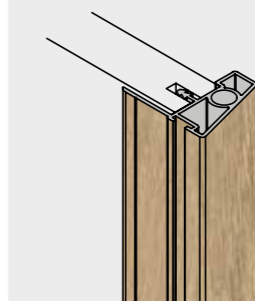

Colori disponibili:
Available colors:

RW3Q	RG9L	CB6K	RC3Q
RS4B	GZ8T	AL1A	BI7A

MONDRIAN

È possibile personalizzare le facciate dell'armadio specificando i colori desiderati per ogni quadrotto. Per il corretto posizionamento dei quadrotti è indispensabile inviare un disegno dell'armadio.

Wardrobe fronts can be customised by specifying the colours required for each square panel. For correct positioning of the square panels, it is essential to send a drawing of the wardrobe.

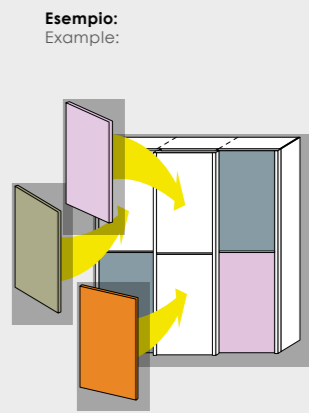

STRAPPO

L'anta laterale Dx dell'armadio ha un riporto laccato, in pannello di MDF Sp 0,4, applicato in posizione prestabilita (vedi soluzioni proposte). N.B. Il colore scelto per il riporto STRAPPO determinerà automaticamente anche la finitura delle ante scorrevoli sprovviste di riporto.

The R side door of the wardrobe has a lacquered MDF insert panel Th 0.4 applied in a pre-established position (see proposed solutions in the catalogue). N.B. The colour chosen for the STRAPPO insert panel will automatically determine the finish for the sliding doors without the insert panel.

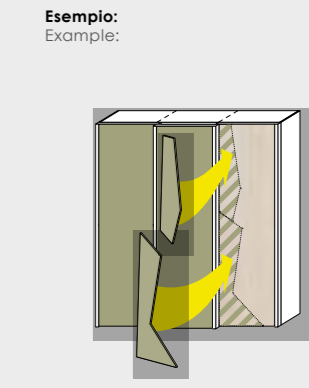





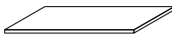
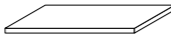
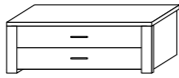
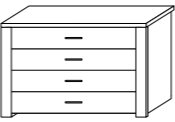
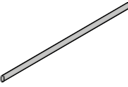

SP7L	GL4R	BI7A	GZ8T	LV5T	CQ3QGZ8A	AB3C	OR7L	EG4L
------	------	------	------	------	----------	------	------	------

pag. 77 Elementi terminali
End elements
pag. 84 Accessori per armadi con ante scorrevoli
Wardrobes with sliding doors accessories
pag. 86 Fasce di tamponamento
Filler strips

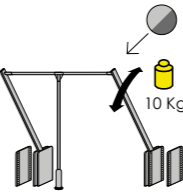
Accessori per armadi con ante scorrevoli

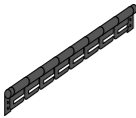
Wardrobes with sliding doors accessories

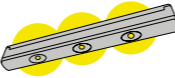
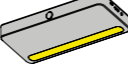
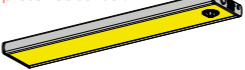
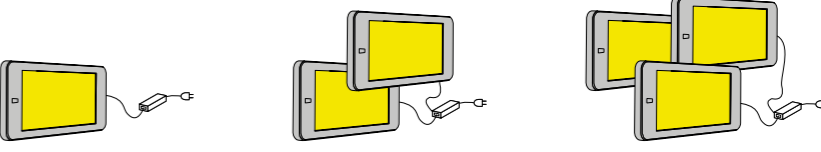
	<p>Ripiano interno Sp 2,5 Inner shelf Th 2.5</p> <p>L W 86,3 P Dpt 51,5</p> 	<p>Ripiano interno Sp 3,5 Inner shelf Th 3.5</p> <p>L W 86,3 P Dpt 51,5</p> 	<p>Cassettiere interne P 46 Inner chests of drawers Dpt 46</p> <p>L W 86,3 H Ht 36,3</p> 	<p>L W 86,3 H Ht 68,3</p> 	<p>Tubo appendiabiti Clothes hanging rail</p> <p>L W 86,3</p> 	<p>Bastone prendi abito Reacher pole</p> <p>H Ht 115</p> <p>In metallo Metal</p> 	<p>Saliscendi per abiti Slide rail for clothes</p> <p>H Ht 84</p> 	<p>Appendi abiti scorrevole Sliding clothes rail</p> <p>Consigliati per armadi ridotti in profondità: P 40 = per profondità superiori a 40 cm. P 24,5 = per profondità inferiori a 40 cm.</p> <p>Recommended for wardrobes with small depth: Dpt 40 = for depth greater than 40 cm. Dpt 24.5 = for depth less than 40 cm.</p> 	
COD.	VF34.41N	VF31.21P	VF34.42U	VF34.43A	VF34.44G	VF32.97V	VF33.11S	VF32.30S	VF32.31Y
	<p>Porta cravatte Tie hanging rack</p> <p>L W 35,2</p> <p>Applicabile sul fianco dell'armadio Apply to the side of wardrobe</p> 	<p>Appendi scarpe Hanging shoes rack</p> <p>L W 45 ÷ 70</p> <p>Applicabile sul fianco dell'armadio Apply to the side of wardrobe</p> 	<p>Lampada led SPARK SPARK led lighting</p> <p>Ø 9,1 Sp Th 4,4</p> <p>Interruttore manuale o sensore di luce azionabile con interruttore laterale. Applicabile con le viti fornite o con velcro biadesivo. 3 batterie da 1,5v AAA non incluse.</p> <p>Manual switch or light sensor that can be operated with the side switch. Applied with the provided screws or with biadhesive tape. 3 - 1.5v AAA batteries not included.</p> 	<p>Lampada led SKY SKY led lighting</p> <p>H Ht 2,2 P Dpt 1,5 L W 17</p> <p>Interruttore touch integrato. Applicabile con le viti fornite o con biadesivo. 3 batterie da 1,5v AAA non incluse.</p> <p>Built-in touch switch. Applied with the provided screws or with biadhesive tape. 3 - 1.5v AAA batteries not included.</p> 	<p>Lampada LED LED lamp</p> <p>L W 15 P Dpt 6,5 H Ht 1,4</p> <p>Dotata di batteria al litio integrata ricaricabile tramite cavo micro USB (non incluso). Applicabile con le viti fornite o con calamite adesive. Con sensore di presenza.</p> <p>Equipped with integrated lithium battery rechargeable via micro USB cable (not included). Applied with the supplied screws or with adhesive magnets. With presence sensor.</p> 	<p>Lampada led SMARTY SMARTY led lamp</p> <p>L W 40,5 P Dpt 4 H Ht 1</p> <p>Dotata di batteria integrata ricaricabile tramite cavo USB (incluso). Si aggancia a due placche magnetiche applicabili con viti o biadesivo forniti. Con sensore di presenza.</p> <p>Equipped with integrated battery rechargeable via USB cable (included). Attaches to two magnetic plates that can be applied with the screws or double-sided tape provided. With presence sensor.</p> 	<p>Illuminazione con sensore Lighting with sensor</p> <p>L W 11,2 P Dpt 19,2 Sp Th 0,6</p> <p>Kit completi di 1 alimentatore. Cover colore Alluminio e Titanio.</p> <p>Complete kits with 1 Power pack. Cover color Aluminum and Titanium.</p> 		
COD.	VF32.98B	VF32.99H	VF32.59M	VF32.60H	VF32.58E	VF34.99S	VF32.63C	VF32.64K	VF32.65R

Fasce di tamponamento

Filler strips

	Fascia di tamponamento verticale (vena verticale) per anta battente e scorrevole Vertical infill (vertical vein) for left or right opening and sliding door	Fascia di tamponamento verticale con sormonto (vena verticale) per anta battente Vertical infill with overlap (vertical vein) for left or right opening door	Fascia di tamponamento orizzontale (vena orizzontale) per anta battente Horizontal infill (Horizontal vein) for left or right opening door
COD.	VF16.34D	VF16.35L	VF16.36S
<div style="display: flex; justify-content: space-around;"> (A) (B) </div>			
	 <p> Fianco Side panel Parete Wall Anta Door </p>	 <p> Fianco Side panel Parete Wall Anta Door </p>	 <p> Soffitto Ceiling Anta Door </p>
	<p> Altezza minima: 320 mm Minimum height: </p> <p> Altezza massima: 3.000 mm Maximum height </p> <p> Larghezza minima: 40 mm Minimum width: </p> <p> Larghezza massima: 250 mm Maximum width: </p>	<p> Altezza minima: 320 mm Minimum height: </p> <p> Altezza massima: 3.000 mm Maximum height </p> <p> Larghezza minima: 40 mm Minimum width: </p> <p> Larghezza massima: 250 mm Maximum width: </p>	<p> Altezza minima: 40 mm Minimum height: </p> <p> Altezza massima: 250 mm Maximum height </p> <p> Larghezza minima: 320 mm Minimum width: </p> <p> Larghezza massima: 3.000 mm Maximum width: </p>

Sistema COMBY - H 44,7 P 46,5

COMBY system - Ht 44.7 Dpt 46.5

Sono dotati di ferramenta regolabile per fissaggio a parete.
They are equipped with adjustable hardware for wall mounting.

Misure d'ingombro:
Overall dimensions:

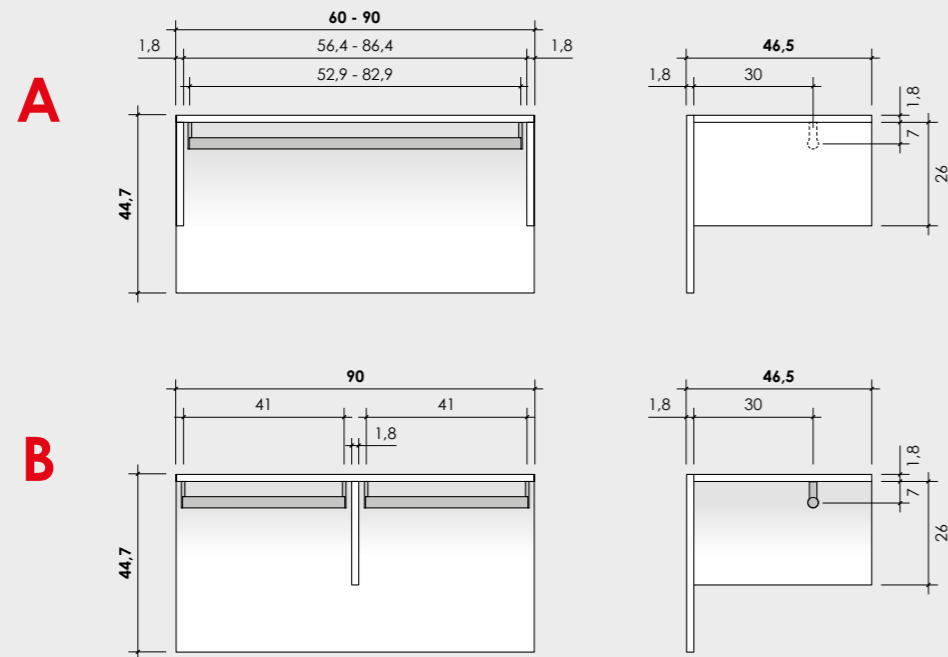

Esempio di utilizzo:
Use example:

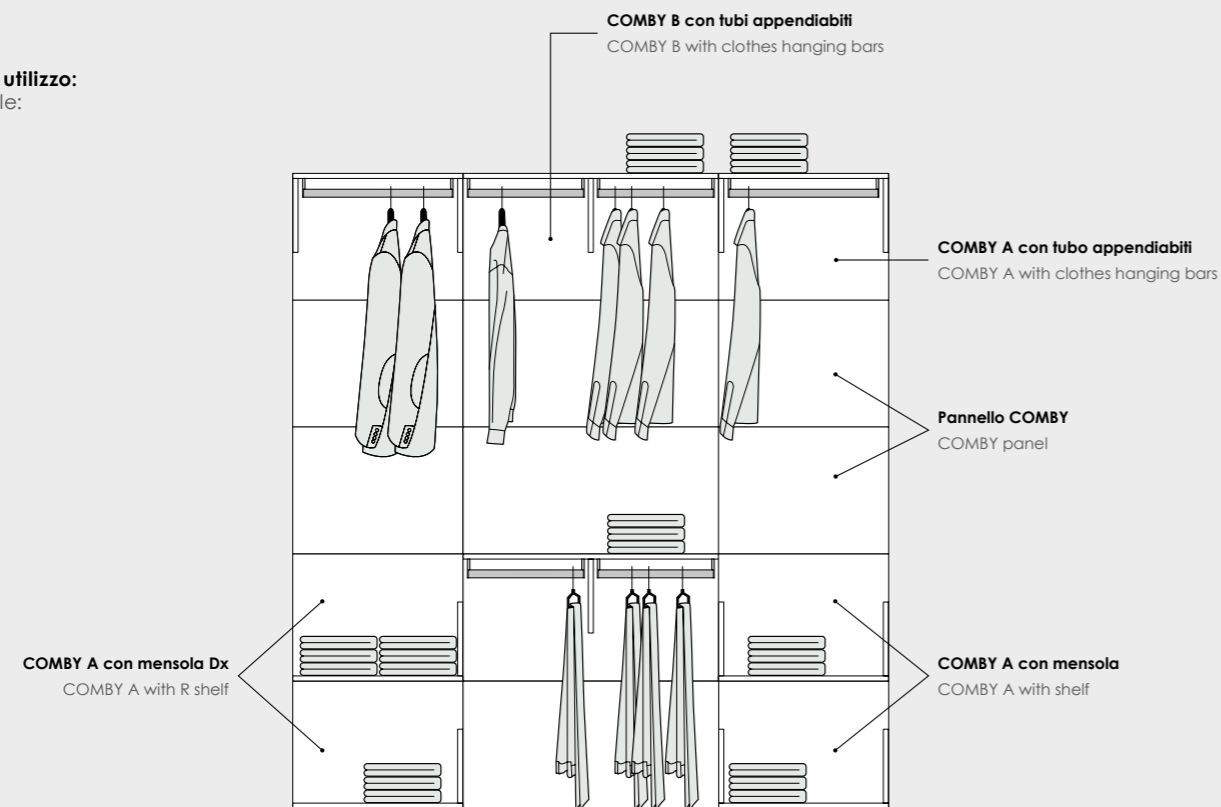

A	Con tubo appendiabito With clothes hanging bar		Mensola Shelf	
	L W	60	Sx L	Dx R
		25 Kg	15 Kg	15 Kg
COD.		VF03.80P	VF03.81V	VF03.82B
	A B			

A	Con tubo appendiabito With clothes hanging bar		Mensola Shelf	
	L W	90		
		25 Kg	25 Kg	
COD.		VF03.84Q	VF03.85W	
	A B			

B	Con tubi appendiabiti With clothes hanging bars		Mensola Shelf	
	L W	90		
		20 Kg	20 Kg	
COD.		VF03.86C	VF03.87K	
	A B			

Pannelli COMBY COMBY panels	H Ht 44,7 L W 60 Sp Th 1,8		H Ht 44,7 L W 90 Sp Th 1,8	
COD.		VF03.88R	VF03.89X	
	A B			

ALIA G28T
Carico massimo consigliato.
Maximum recommended load.

Facciate Fronts
VOLO

Finiture GRUPPO 1
GROUP 1 finishes

Finiture GRUPPO 2
GROUP 2 finishes

Rovere white*

A ☆ Rovere white RW3Q	A ☆ Rovere gesso RG9L	A ☆ Ciliegio bianco CB6K	A Grigio Dorian GL4R	B ☆ Cemento antico CA7A	B ☆ Rovere cognac RC3Q
B ☆ Royal oak RS4B	B Grigio titanio GZ8T	B Oliva LV5T	B Cadaques CQ3Q		
A Bianco opaco B17A	B Giallo zafferano GZ8A	B Albicocca AB3C	B Orchidea OR7L	B Blu Egeo EG4L	

Vetri Glass

Ante Doors
WINDOW

Colori telaio
Frame colours

Trasparente TR9M	Trasparente fumé FT8P	Stop sol ST6P	Specchio SP7L	Alluminio AL1A	Titan grey TG7H
----------------------------	---------------------------------	-------------------------	-------------------------	--------------------------	---------------------------

Rovere white* Finitura unica per tutti i componenti in pannello presenti a listino non evidenziati con il colore Finiture GRUPPO 1 e/o Finiture GRUPPO 2.
Unique finish for all the panel components shown in the pricelist not highlighted with the color finishes GROUP 1 and/or finishes GROUP 2.

- A** Finiture in fascia di prezzo A
Finishes in price range A
- B** Finiture in fascia di prezzo B
Finishes in price range B
- ☆ Finiture con effetto materico
Finishes with textured effect

ARMADI PONTE, LETTI A SOPPALCO E A CASTELLO
BRIDGE WARDROBES, LOFT AND BUNK BEDS

Armadi a ponte - H 257,6 P 56,3 Bridge wardrobes - Ht 257.6 Dpt 56.3	pag. 92
Letti a soppalco BRIDGE - H 257,6 P 95 - per scaletta in metallo BRIDGE loft beds - Ht 257.6 Dpt 95 - for metal ladder	pag. 94
Letti a soppalco BRIDGE - H 257,6 P 100 - con scaletta laterale BRIDGE loft beds - Ht 257.6 Dpt 100 - with side stair	pag. 96
Accessori per armadi ponte e letti a soppalco Bridge wardrobes and loft beds accessories	pag. 98
Letti a castello WINNER - H 187 L 101,5 - per scaletta in metallo WINNER bunk beds - Ht 187 W 101.5 - for metal ladder	pag. 100
Letti a castello WINNER - H 187 L 101,5 - con scaletta laterale WINNER bunk beds - Ht 187 W 101.5 - with side stair	pag. 101
Letti a castello REVOLUTION - H 198 L 210 REVOLUTION bunk beds - Ht 198 W 210	pag. 102
Letti a castello REVOLUTION - H 198 L 210 - con cabina REVOLUTION bunk beds - Ht 198 W 210 - with walk-in wardrobe	pag. 104
Letti a castello REVOLUTION - H 198 L 210 - con armadio REVOLUTION bunk beds - Ht 198 W 210 - with wardrobe	pag. 106
Accessori per letti a castello REVOLUTION REVOLUTION bunk beds accessories	pag. 108
Letti a castello TITANO - H 179,3 L 200 TITANO bunk beds - Ht 179.3 W 200	pag. 110

Armadi a ponte - H 257,6 P 56,3

Bridge wardrobes - Ht 257.6 Dpt 56.3

- Sono dotati di 1 tubo appendiabiti per vano.
- I pannelli retro sono dotati di piedini regolabili.

- Each compartment is equipped with 1 clothes hanging rail.
- Back panels are equipped with adjustable feet.

Armadio a ponte su misura:
Custom-made bridge wardrobe:

Elementi sopra barra
Over bar elements
H Ht **128**

Vano ponte
Niche of overhead structure
H Ht **129,6**

	L W 118	L W 178	L W 208	L W 223	L W 238		
COD.	VF04.00Z	VF04.01F	VF04.02N	VF04.03U	VF04.06P	VF04.04A	VF04.05G
VOLO	(A)	(B)	(A)	(B)	(A)	(B)	(A)
WINDOW	(A)	(B)	(A)	(B)	(A)	(B)	(A)

Elementi sopra barra
Over bar elements
H Ht **96**

Vano ponte
Niche of overhead structure
H Ht **161,6**

	L W 118	L W 178	L W 208	L W 223	L W 238		
COD.	VF04.10E	VF04.11M	VF04.12T	VF04.13Z	VF04.16U	VF04.14F	VF04.15N
VOLO	(A)	(B)	(A)	(B)	(A)	(B)	(A)
WINDOW	(A)	(B)	(A)	(B)	(A)	(B)	(A)

Mensele sottoponte
Shelves for use beneath overhead composition
P Dpt 26,5
Sp Th 2,5

	L W 118	L W 178	L W 208	L W 223	L W 238		
COD.	VF04.20L	VF04.21S	VF04.22Y	VF04.23E	VF04.24M		
Con reggimensola With shelf holders	(A)	(B)	(A)	(B)	(A)	(B)	(A)
LAMPO	(A)	(B)	(A)	(B)	(A)	(B)	(A)
KUB	(A)	(B)	(A)	(B)	(A)	(B)	(A)



Provvisti di ferramenta per fissaggio a pannello.
In caso di fissaggio a muro la scelta del tipo di tassello da utilizzare dovrà essere fatta dal montatore sulla base delle caratteristiche della parete.
Complete with hardware for fixing to panel.
In case of wall fixing the choice of hardware depends on the wall conditions and should be made by the assembler.

Fianchi di sostegno per pensile H 128
Support side panels for wall unit Ht 128

P Dpt 54,5

Sp Th 1,8



Fianchi di sostegno per pensile H 96
Support side panels for wall unit Ht 96

P Dpt 54,5

Sp Th 1,8

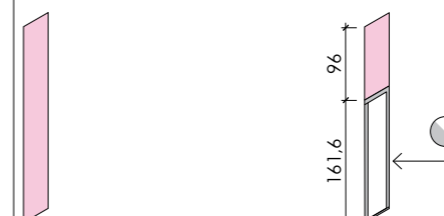

Informazioni tecniche:
Technical information:

È indispensabile completare le composizioni con i fianchi di sostegno o gli armadi P 56,3. L'elemento sopra barra è costituito da cappello e fondo interi e da tramezzi interni (vedi tratteggi).

It is absolutely necessary to complete compositions with side support panels or wardrobes Dpt 56.3. The over bar element consists of an inner top and bottom and internal partitions (see hatches).

- | | | |
|---|----------------|--------------|
| 1 | Tramezzo | Partition |
| 2 | Cappello | Top |
| 3 | Fondo | Bottom panel |
| 4 | Pannello retro | Back panel |
| 5 | Barra ponte | Overhead bar |

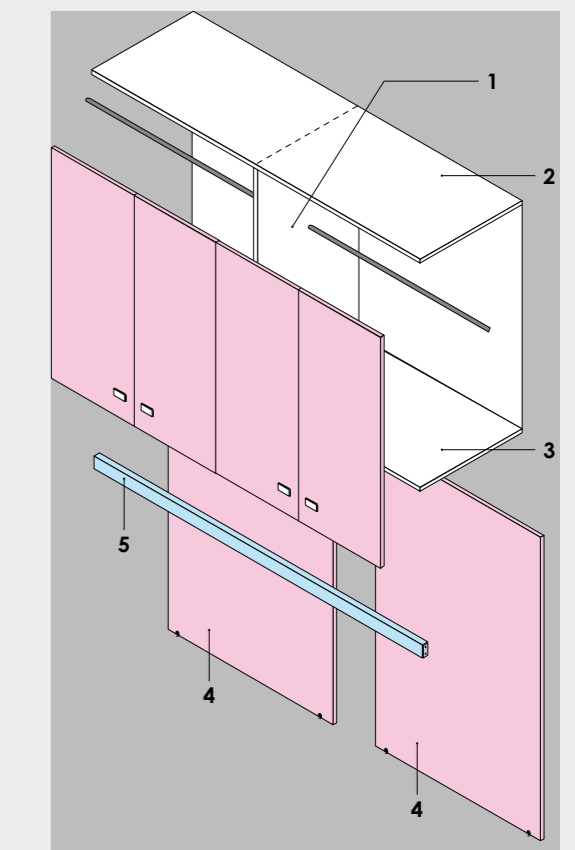

CARICO MASSIMO CONSIGLIATO
(al netto delle mensole)

MAXIMUM RECOMMENDED LOAD
(shelves weight excluded)

30 Kg per ogni coppia di reggimensola
for every pair of shelf holders

NB. Il carico si intende uniformemente distribuito sulla mensola. Tra 2 reggimensola ci deve essere una distanza non superiore a 135 cm.

NOTE. Load shall be evenly distributed on the shelf. The maximum distance between 2 shelf holders shall be 135 cm.

Letti a soppalco BRIDGE - H 257,6 P 95 - per scaletta in metallo

BRIDGE loft beds - Ht 257.6 Dpt 95 - for metal ladder

- Il letto è utilizzabile anche senza rete.
- Sono dotati di 1 tubo appendiabiti per vano.
- I pannelli retro sono dotati di piedini regolabili.

- The bed can also be used without a bed base.
- Each compartment is equipped with 1 clothes hanging rail.
- Back panels are equipped with adjustable feet.

	L W 257,3	L W 302,3	
CON 2 BARRE PONTE WITH 2 OVERHEAD BARS			
Specificare Sx o Dx (disegno Dx) Specify L or R (R drawing)			
Elemento soprabarra Over bar element			
H Ht 128			
Vano ponte Niche of overhead structure			
H Ht 129,6 L W 208			
COD.	VF04.50B	VF04.51H	VF04.52Q
VOLO	(A) (B)		
CON PANNELLI RETRO WITH BACK PANELS			
Specificare Sx o Dx (disegno Dx) Specify L or R (R drawing)			
Elemento soprabarra Over bar element			
H Ht 128			
Vano ponte Niche of overhead structure			
H Ht 129,6 L W 208			
COD.	VF04.60G	VF04.61P	VF04.04A VF04.05G
VOLO	(A) (B)		

Informazioni tecniche:
Technical information:

- È indispensabile completare le composizioni con i fianchi di sostegno o gli armadi P 56,3, la protezione e la scaletta in metallo.
- Posizionabili esclusivamente a parete.
- Il letto è utilizzabile anche senza rete.
- Vano ponte H 129,6 - L 208.
- It is absolutely necessary to complete compositions with side support panels or wardrobes Dpt 56.3, guard and the metal ladder.
- Can only be positioned against a wall.
- The bed can be used without bed base.
- Niche of overhead structure Ht 129.6 - W 208.

1 Barra ponte	Overhead bar
2 Pediera letto, fianco strutturale armadio P 90	Bed footboard, structural side wardrobe Dpt 90
3 Pannello retro L 59	Back panel W 59
4 Pannello retro L 90	Back panel W 90
5 Interno letto 200,6 x 84,7 Per materasso 190 x 80	Internal dimension 200.6 x 84.7 For mattress 190 x 80
6 Portariviste	Magazine rack

Mensola sottoponte
Shelf for use beneath overhead composition

P Dpt 26,5
Sp Th 2,5

COD. **VF04.22Y**

Con reggimensola With shelf holders

LAMPO (A)
KUB (A)

CARICO MASSIMO CONSIGLIATO
(al netto delle mensole)
MAXIMUM RECOMMENDED LOAD
(shelves weight excluded)

30 Kg per ogni coppia di reggimensola
for every pair of shelf holders

NB. Il carico si intende uniformemente distribuito sulla mensola. Tra 2 reggimensola ci deve essere una distanza non superiore a 135 cm.

NOTE. Load shall be evenly distributed on the shelf. The maximum distance between 2 shelf holders shall be 135 cm.

	Protezioni (fisse) Guard (fixed)	WINNER	MASCHERA	Scaletta in metallo Metal ladder
	FLIP L W 155 H Ht 26 Sp Th 1,8	L W 150 H Ht 35 Sp Th 2,5	L W 150 H Ht 29	PEG L W 35 H Ht 148,7
COD.	VF33.16Z	VF33.17F	VF33.18N	VF33.19U
VOLO	(A) (B)			

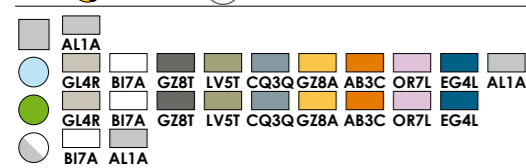

Provvisti di ferramenta per fissaggio a pannello.
In caso di fissaggio a muro la scelta del tipo di tassello da utilizzare dovrà essere fatta dal montatore sulla base delle caratteristiche della parete.
Complete with hardware for fixing to panel.
In case of wall fixing the choice of hardware depends on the wall conditions and should be made by the assembler.

pag. 40
pag. 98
pag. 142

Posizionamento pomelli e maniglie
Knobs and handles position
Accessori per armadi ponte e letti a soppalco
Overhead wardrobes and loft beds accessories
Materassi e guanciali
Mattresses and pillows

Letti a soppalco BRIDGE - H 257,6 P 100 - con scaletta laterale

BRIDGE loft beds - Ht 257.6 Dpt 100 - with side stair

- Il letto è utilizzabile anche senza rete.
- Sono dotati di 1 tubo appendiabiti per vano.
- I pannelli retro sono dotati di piedini regolabili.

- The bed can also be used without a bed base.
- Each compartment is equipped with 1 clothes hanging rail.
- Back panels are equipped with adjustable feet.

CON 2 BARRE PONTE WITH 2 OVERHEAD BARS

Specificare Sx o Dx (disegno Dx)
Specify L or R (drawing)

Elemento soprabarra Over bar element

H Ht 128

Vano ponte Niche of overhead structure

H Ht 129,6 L W 208

COD. VF04.70N VF04.71U

VOLO (A) (B)

L W 304,8

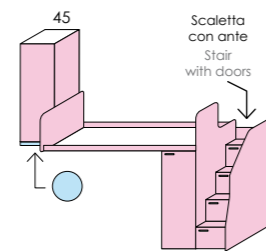
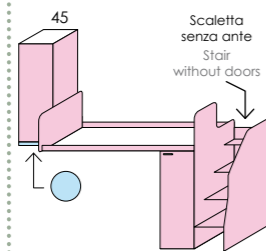

L W 349,8

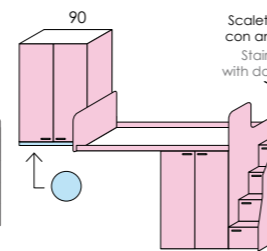
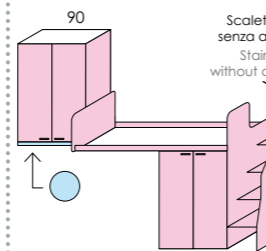

Fianchi di sostegno Support side panels

P Dpt 54,5

Sp Th 1,8



COD. VF04.52Q

CON PANNELLI RETRO WITH BACK PANELS

Specificare Sx o Dx (disegno Dx)
Specify L or R (drawing)

Elemento soprabarra Over bar element

H Ht 128

Vano ponte Niche of overhead structure

H Ht 129,6 L W 208

COD. VF04.80T VF04.81Z

VOLO (A) (B)

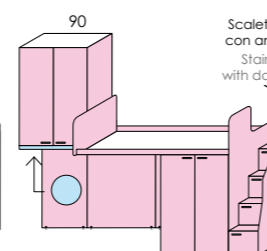
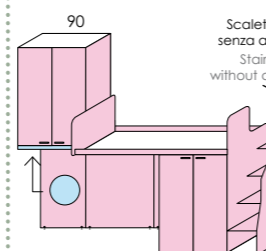
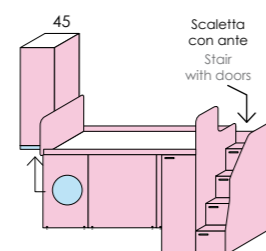
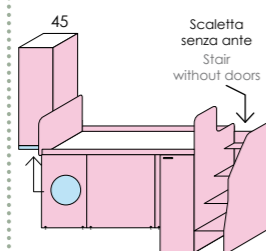

Fianchi di sostegno Support side panels

P Dpt 54,5

Sp Th 1,8

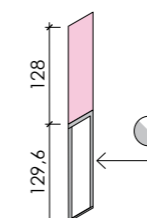

COD. VF04.04A

VF04.05G

Mensola sottoponte Shelf for use beneath overhead composition

P Dpt 26,5

Sp Th 2,5

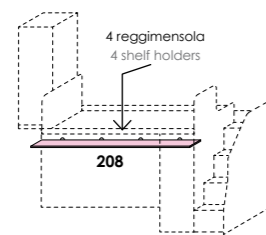

COD. VF04.22Y

Con reggimensola With shelf holders
LAMPO (A) (B)
KUB (A) (B)

CARICO MASSIMO CONSIGLIATO (al netto delle mensole)

MAXIMUM RECOMMENDED LOAD
(shelves weight excluded)

30 Kg per ogni coppia di reggimensola
for every pair of shelf holders

NB. Il carico si intende uniformemente distribuito sulla mensola. Tra 2 reggimensola ci deve essere una distanza non superiore a 135 cm.

NOTE. Load shall be evenly distributed on the shelf. The maximum distance between 2 shelf holders shall be 135 cm.

Provisti di ferramenta per fissaggio a pannello.
In caso di fissaggio a muro la scelta del tipo di tassello da utilizzare dovrà essere fatta dal montatore sulla base delle caratteristiche della parete.
Complete with hardware for fixing to panel.
In case of wall fixing the choice of hardware depends on the wall conditions and should be made by the assembler.

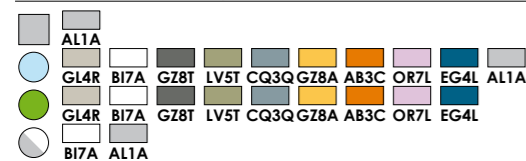

Informazioni tecniche: Technical information:

- È indispensabile completare le composizioni con i fianchi di sostegno o gli armadi P 56,3 e la protezione.
- Posizionabili esclusivamente a parete.
- Il letto è utilizzabile anche senza rete.
- La scaletta è strutturale: non è possibile escluderla.
- Vano ponte H 129,6 - L 208.
- It is absolutely necessary to complete compositions with side support panels or wardrobes Dpt 56.3 and guard.
- Can only be positioned against a wall.
- The bed can be used without bed base.
- The stair are part of the structure: they cannot be excluded.
- Niche of overhead structure Ht 129.6 - W 208.

1 Barra ponte	Overhead bar
2 Pediera letto, fianco strutturale armadio P 90 e fianco strutturale scaletta in legno	Bed footboard, structural side wardrobe Dpt 90 and structural side wood stair
3 Pannello retro L 59	Back panel W 59
4 Pannello retro L 90	Back panel W 90
5 Interno letto 200,6 x 84,7 Per materasso 190 x 80	Internal dimension 200.6 x 84.7 For mattress 190 x 80
6 Portariviste	Magazine rack

Protezioni (fisse) Guard (fixed)

FLIP

L W 190
H Ht 26
Sp Th 1,8

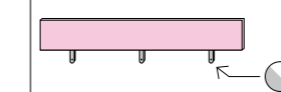

WINNER

L W 189
H Ht 35
Sp Th 2,5

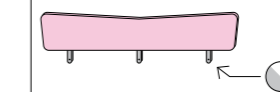

MASCHERA

L W 183
H Ht 29

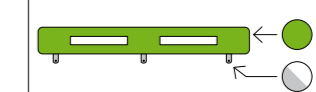

COD.

VF33.21X

VF33.22D

VF33.23L

(A) (B)

Accessori per armadi ponte e letti a soppalco

Bridge wardrobes and loft beds accessories

ACCESSORI PER ARMADI PONTE

BRIDGE WARDROBES ACCESSORIES

Ripiani interni

Inner shelves

Sp	Th	2,5
P	Dpt	51,5
L	W	43,1
		58,1
		88,1

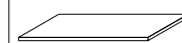

Tubi appendiabiti

Clothes hanging rails

L	W	43,1
		58,1
		88,1

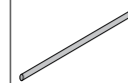

L W	COD.	COD.
45	VF32.80U	VF32.86H
60	VF32.81A	VF32.87Q
90	VF32.82G	VF32.88W

ACCESSORI PER LETTI A SOPPALCO

LOFT BEDS ACCESSORIES

Ripiani interni

Inner shelves

Sp	Th	2,5
P	Dpt	51,5
L	W	43,1
		88,1

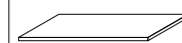

Ripiani interni

Inner shelves

Sp	Th	2,5
P	Dpt	29,2
L	W	45
		90

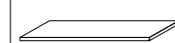

Per amadio P 90
For wardrobe Dpt 90

Tubi appendiabiti

Clothes hanging rails

L	W	43,1
		88,1

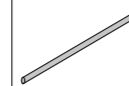

L	W	45
		90

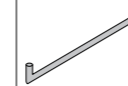

Per amadio P 90
For wardrobe Dpt 90

Reti a doghe

Roll-up bases

L	W	80
P	Dpt	190

Avvolgibile
Roll-up



L	W	80
P	Dpt	190



L W	COD.	COD.	COD.	COD.	COD.
45	VF32.80U	VF33.12Y	VF32.86H	VF33.14M	
90	VF32.82G	VF33.13E	VF32.88W	VF33.15T	

ACCESSORI COMUNI

SHARED ACCESSORIES

Saliscendi per abiti

Slide rail for clothes

H	Ht	84
---	----	----

Per elementi sopra-barra L 90
For over-bar elements W 90

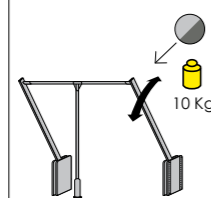

Bastone prendi abito

Reacher pole

H	Ht	115
---	----	-----

In metallo
Metal

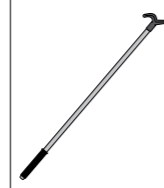

COD.	COD.
VF32.89C	VF32.97V

Letti a castello WINNER - H 187 L 101,5 - per scaletta in metallo

WINNER bunk beds - Ht 187 W 101.5 - for metal ladder

Letti a castello WINNER - H 187 L 101,5 - con scaletta laterale

WINNER bunk beds - Ht 187 W 101.5 - with side stair

Rete estraibile L 80 (materasso H 12 max).
Pull-out bed base W 80 (mattress Ht 12 max).

Rete estraibile L 80 (materasso H 12 max).
Pull-out bed base W 80 (mattress Ht 12 max).

P Dpt **200**

P Dpt **247,5**

rete L bed base W	COD.	interno letto internal dimensions	COD.	interno letto internal dimensions	COD.	interno letto internal dimensions
90	VF04.90Y	91,5 x 194	VF04.91E	91,5 x 194	VF04.92M	91,5 x 194

rete L bed base W	COD.	interno letto internal dimensions	COD.	interno letto internal dimensions	COD.	interno letto internal dimensions
90	VF04.93T	91,5 x 194	VF04.94Z	91,5 x 194	VF04.95F	91,5 x 194

Protezioni (fisse) Guard (fixed)

FLIP

L W 155
H Ht 26
Sp Th 1,8

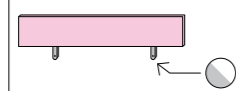

WINNER

L W 150
H Ht 35
Sp Th 2,5

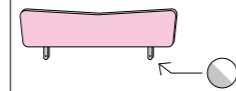

MASCHERA

L W 150
H Ht 29



Scaletta in metallo Metal ladder

PEG

L W 35
H Ht 148,7

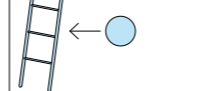

COD.	VF33.16Z	VF33.17F	VF33.18N	VF33.19U
(A)				
(B)				

Protezioni (fisse) Guard (fixed)

FLIP

L W 190
H Ht 26
Sp Th 1,8

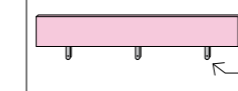

WINNER

L W 189
H Ht 35
Sp Th 2,5

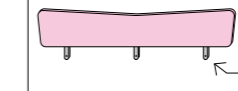

MASCHERA

L W 183
H Ht 29

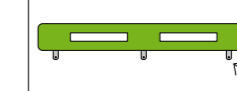

COD.	VF33.21X	VF33.22D	VF33.23L
(A)			
(B)			

Informazioni tecniche: Technical information:

- È obbligatorio ordinare 1 o più protezioni e la scaletta in metallo PEG.
- 1 or more guards and the PEG metal ladder must be ordered.

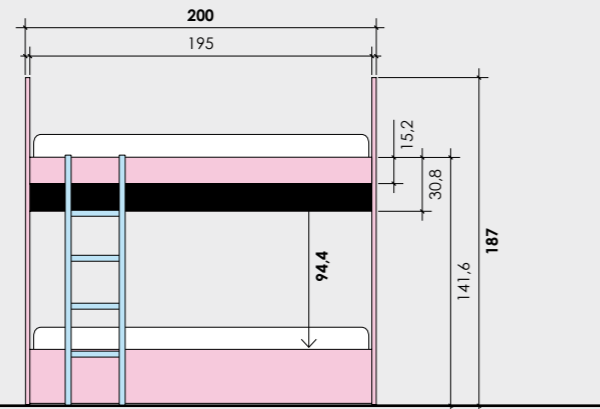

Pavimento
Floor

Informazioni tecniche: Technical information:

Esempio Sx
Left example

- È obbligatorio ordinare 1 o più protezioni.
- La scaletta è strutturale: non è possibile escluderla.
- 1 or more guards must be ordered.
- The stair are part of the structure: they cannot be excluded.

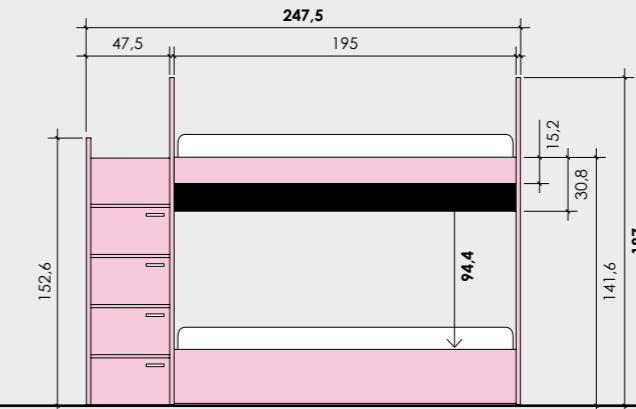

Pavimento
Floor

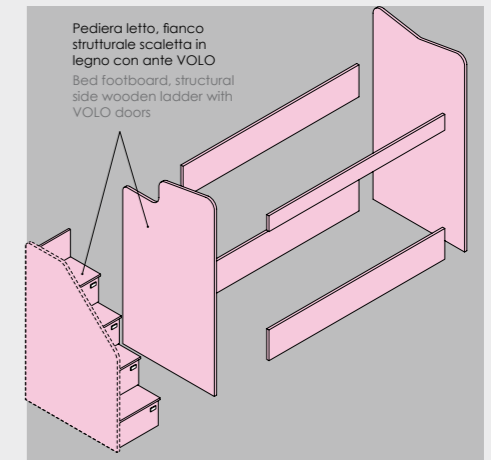

Accessori Accessories

Materasso in spugna Foam mattress

L W 81,5
P Dpt 189
H Ht 12

per rete inferiore estraibile
for pull-out lower base
con fodera
with cover

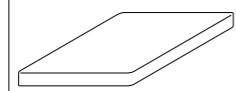

COD.	VF33.24S
------	----------



Accessori Accessories

Materasso in spugna Foam mattress

L W 81,5
P Dpt 189
H Ht 12

per rete inferiore estraibile
for pull-out lower base
con fodera
with cover

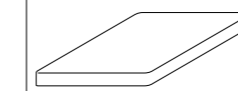

COD.	VF33.24S
------	----------

pag. 40
pag. 142

Posizionamento pomelli e maniglie
Knobs and handles position
Materassi e guanciali
Mattresses and pillows

Letti a castello REVOLUTION - H 198 L 210

REVOLUTION bunk beds - Ht 198 W 210

- In fase di ordinazione è necessario aggiungere: una scaletta metallica o con fianchi sagomati e una protezione.
 - Posizionabili esclusivamente a parete.
 - Volta colore Rovere white (RW3Q).
 - Rete a doghe strutturale L 90 o 120 P 205 (per materasso L 90 o 120 P 200).
 - I disegni rappresentano i letti a castello P 127,3.
- When ordering, the metal ladder or the ladders with shaped sides and one or more guards have to be added.
 - Positionable exclusively on the wall.
 - Hidden base support in Rovere white (RW3Q) colour.
 - Wooden slatted structural base W 90 or 120 Dpt 205 (for mattress W 90 or 120 Dpt 200).
 - The drawings represent the bunk beds Dpt 127.3.

Fianchi REVOLUTION
REVOLUTION side panel

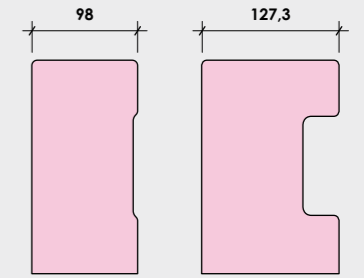

Vano per letto L 205 H 151,5
Niche for bed
W 205 Ht 151.5

- Vuoto**
Empty
- Con mensole**
With shelves
- Con letti scorrevoli TRIS**
With TRIS sliding beds
- Con scrivania e letto scorrevoli TRIS**
With TRIS sliding desk and bed

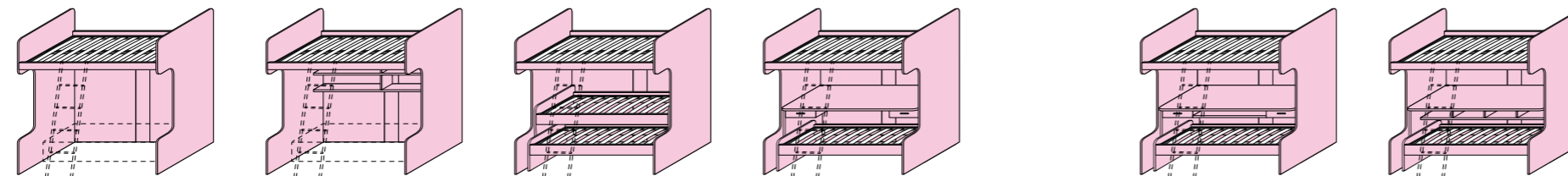

P Dpt 98
Rete superiore L 90
Upper bed base W 90

COD.	VF05.00D	VF05.01L	VF05.02S	VF05.03Y	VF05.04E	VF05.05M
(A)						
(B)						

P Dpt 127,3
Rete superiore L 120
Upper bed base W 120

COD.	VF05.10K	VF05.11R	VF05.12X	VF05.13D	VF05.14L	VF05.15S
(A)						
(B)						

Vano per letto L 205 H 151,5
Niche for bed
W 205 Ht 151.5

Specificare Sx o Dx
(disegni Dx)
Specify L or R
(drawings R)

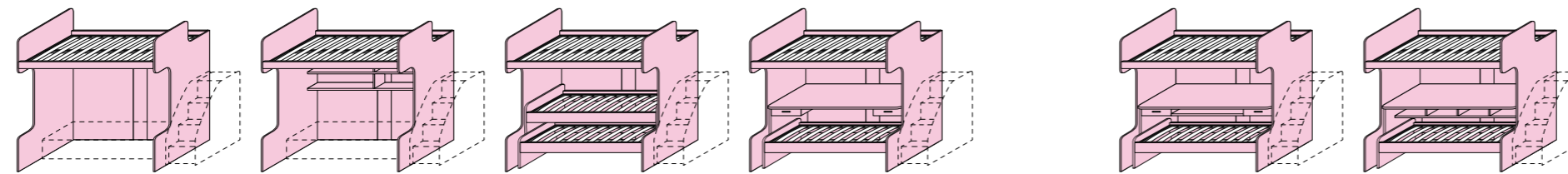

P Dpt 98
Rete superiore L 90
Upper bed base W 90

COD.	VF05.20Q	VF05.21W	VF05.22C	VF05.23K	VF05.24R	VF05.25X
(A)						
(B)						

P Dpt 127,3
Rete superiore L 120
Upper bed base W 120

COD.	VF05.30V	VF05.31B	VF05.32H	VF05.33Q	VF05.34W	VF05.35C
(A)						
(B)						

Mensole
Shelves

L W 205
P Dpt 30,8
H Ht 49

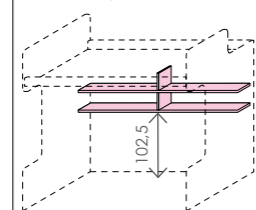

COD. VF33.31C

(A)
(B)

Scrittoi TRIS con ruote anteriori con freno

TRIS writing-desk with wheels with brake at front

Con 2 cassetti

With 2 drawers
L W 202,6
P Dpt 88,5
H Ht 71

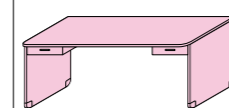

VF33.27M

Con 2 cassetti e piano

With 2 drawers and top
L W 202,6
P Dpt 88,5
H Ht 71

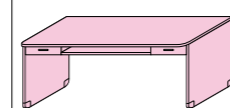

VF33.28T

Con elemento sottopiano

With element below top
L W 202,6
P Dpt 88,5
H Ht 71

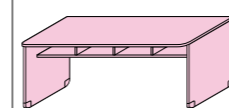

VF33.29Z

Letti TRIS con ruote autofrenanti

TRIS beds with self-braking wheels

Inferiore

Bottom
L W 196,4
P Dpt 89,8
H Ht 36

Rete L 80 (materasso L 80 x 190)
Bed base W 80 (mattress W 80 x 190)

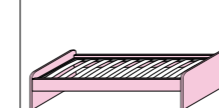

VF33.25Y

Centrale

Central
L W 202,2
P Dpt 93
H Ht 71

Rete L 80 (materasso L 80 x 190)
Bed base W 80 (mattress W 80 x 190)

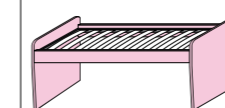

VF33.26E

pag. 40
pag. 108
pag. 142

Posizionamento pomelli e maniglie
Knobs and handles position
Accessori per letti a castello REVOLUTION
REVOLUTION bunk beds accessories
Materassi e guanciali
Mattresses and pillows

Letti a castello REVOLUTION - H 198 L 210 - con cabina

REVOLUTION bunk beds - Ht 198 W 210 - with walk-in wardrobe

- In fase di ordinazione è necessario aggiungere: una scaletta metallica o con fianchi sagomati e una protezione.
 - Posizionabili esclusivamente a parete.
 - Sono dotati di 1 tubo appendiabiti per vano.
 - Volta colore Rovere white (RW3Q).
 - Rete a doghe strutturale L 90 o 120 P 205 (per materasso L 90 o 120 P 200).
 - Apertura ante a soffietto.
 - I disegni rappresentano i letti a castello P 127,3.
- When ordering, the metal ladder or the ladders with shaped sides and one or more guards have to be added.
 - Positionable exclusively on the wall.
 - Each compartment is equipped with 1 clothes hanging rail.
 - Hidden base support in Rovere white (RW3Q) colour.
 - Wooden slatted structural base W 90 or 120 Dpt 205 (for mattress W 90 or 120 Dpt 200).
 - Doors with folding opening.
 - The drawings represent the bunk beds Dpt 127,3.

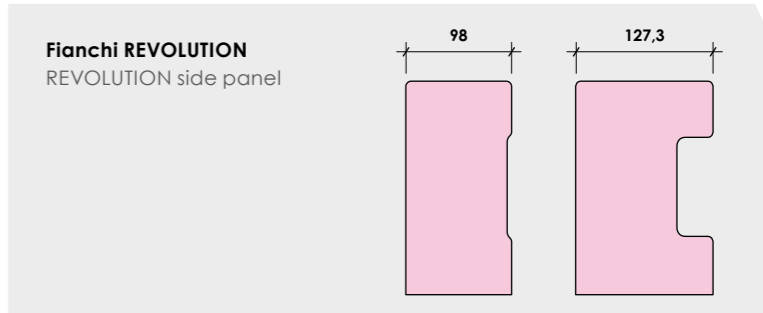

Vano per letto
L 205 H 151,5
Niche for bed
W 205 Ht 151,5

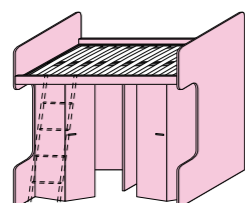

P Dpt 98 Rete superiore L 90 Upper bed base W 90	COD. VF05.06T
	VOLO (A) (B)
P Dpt 127,3 Rete superiore L 120 Upper bed base W 120	COD. VF05.16Y
	VOLO (A) (B)

Vano per letto
L 205 H 151,5
Niche for bed
W 205 Ht 151,5

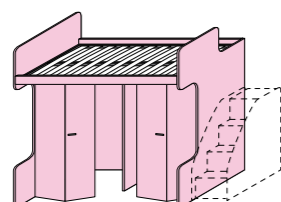

Specificare Sx o Dx (disegni Dx)
Specify L or R (drawings R)

P Dpt 98 Rete superiore L 90 Upper bed base W 90	COD. VF05.26D
	VOLO (A) (B)
P Dpt 127,3 Rete superiore L 120 Upper bed base W 120	COD. VF05.36K
	VOLO (A) (B)

Cabina REVOLUTION

REVOLUTION walk-in wardrobes

Esempio con quote e completo di attrezzatura interna (ripiano interno L 101,2 e cassetiera interna L 90)
Example with heights and complete with internal equipment (internal shelf L 101,2 and internal chest of drawers L 90)

- a Tubo appendiabiti
Clothes hanging rail
- b Tramezzo
Partition
- c Ripiano interno
Inner shelves
- d Cassetiera interna
Inner chests of drawers

Armadi ponte, Letti a
soppalco e a castello
Bidge wardrobes,
Loft and bunk beds

Ripiano interno Inner shelf	Cassettiere interne L 90 - P 45,8 Inner chests of drawers W 90 - Dpt 45,8
L W 101,2 P Dpt 57,1 Sp Th 2,5	H Ht 35 H Ht 67 H Ht 99

Tubo appendiabiti
Clothes hanging rail

L W 101,2

COD.	VF33.57C	VF33.58K	VF33.59R	VF33.60N	VF33.61U
	(A) (B)				



pag. 40 Posizionamento pomelli e maniglie
Knobs and handles position
pag. 108 Accessori per letti a castello REVOLUTION
REVOLUTION bunk beds accessories
pag. 142 Materassi e guanciali
Mattresses and pillows

Letti a castello REVOLUTION - H 198 L 210 - con armadio

REVOLUTION bunk beds - Ht 198 W 210 - with wardrobe

- In fase di ordinazione è necessario aggiungere: una scaletta metallica o con fianchi sagomati e una protezione.
 - Posizionabili esclusivamente a parete.
 - Sono dotati di 1 tubo appendiabiti.
 - Gli armadi inseriti sotto il letto sopralco sono P 93,6.
 - Valta colore Rovere white (RW3G).
 - Rete a doghe strutturale L 90 o 120 P 205 (per materasso L 90 o 120 P 200).
 - I disegni rappresentano i letti a castello P 127,3.
- When ordering, the metal ladder or the ladders with shaped sides and one or more guards have to be added.
 - Positionable exclusively on the wall.
 - Each compartment is equipped with 1 clothes hanging rail.
 - Wardrobes inserted underneath platform beds are Dpt 93.7 cm.
 - Hidden base support in Rovere white (RW3G) colour.
 - Wooden slatted structural base W 90 or 120 Dpt 205 (for mattress W 90 or 120 Dpt 200).
 - The drawings represent the bunk beds Dpt 127.3.

Fianchi REVOLUTION
REVOLUTION side panel

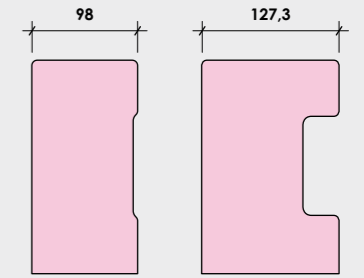

Vano per letto L 102,5 H 151,5
Niche for bed W 102.5 Ht 151.5

Vuoto Empty Con piano fisso With fixed plane Con anta ribalta With pull-down door

L'anta aperta ha la funzione di piano scrittoio.
The open door has the writing desk function.

PORTATA MASSIMA
MAXIMUM CAPACITY
10 Kg

P Dpt 98 Rete superiore L 90 Upper bed base W 90	COD.	VF05.07Z	VF05.08F	VF05.09N
	VOLO	(A)	(B)	(B)
P Dpt 127,3 Rete superiore L 120 Upper bed base W 120	COD.	VF05.17E	VF05.18M	VF05.19T
	VOLO	(A)	(B)	(B)

Vano per letto L 102,5 H 151,5
Niche for bed W 102.5 Ht 151.5

Specificare Sx o Dx (disegni Dx)
Specify L or R (drawings R)

L'anta aperta ha la funzione di piano scrittoio.
The open door has the writing desk function.

PORTATA MASSIMA
MAXIMUM CAPACITY
10 Kg

P Dpt 98 Rete superiore L 90 Upper bed base W 90	COD.	VF05.27L	VF05.28S	VF05.29Y
	VOLO	(A)	(B)	(B)
P Dpt 127,3 Rete superiore L 120 Upper bed base W 120	COD.	VF05.37R	VF05.38X	VF05.39D
	VOLO	(A)	(B)	(B)

Ripiano interno Inner shelf	Tubo appendiabiti Clothes hanging rail
L W 98,8 P Dpt 51,5 Sp Th 2,5	L W 98,8
COD. VF33.62A	COD. VF33.65V

ALTA
Frontali disponibili con apertura PUSH-PULL
Fronts available with PUSH-PULL opening

pag. 40 Posizionamento pomelli e maniglie
Knobs and handles position
pag. 108 Accessori per letti a castello REVOLUTION
REVOLUTION bunk beds accessories
pag. 142 Materassi e guanciali
Mattresses and pillows

Accessori per letti a castello REVOLUTION

REVOLUTION bunk beds accessories

Scaletta in metallo MAO

MAO metal ladder

con fissaggio
with fixing

L W 35
H Ht 162,8

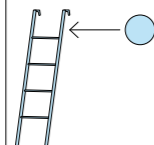

COD. VF33.32K

Scalette con fianchi sagomati LEA

LEA ladders with shaped side panels

con ante
with doors

L W 50
P Dpt 105,3
H Ht 120

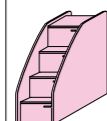

con ante e corrimano
with doors and handrail

L W 54
P Dpt 105,3
H Ht 184,3

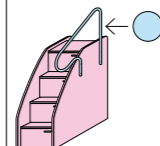

Corrimano per LEA

Handrail for LEA

Ø 3,2
P Dpt 92
H Ht 100

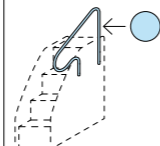

COD. VF35.08R

COD. VF35.09X

COD. VF35.10U

VOLO A
B

Specificare cerniera Sx o Dx
(disegno Sx)
Specify hinge L or R
(drawing L)

Protezioni per scaletta MAO

Guards for MAO ladder

SHAPE

L W 163
H Ht 38

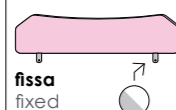

fissa
fixed



reclinabile
reclining

Protezioni per scaletta LEA

Guards for LEA ladder

SHAPE

L W 204
H Ht 38

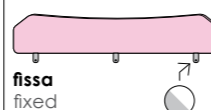

fissa
fixed



reclinabile
reclining

COD. VF33.36L

COD. VF33.38Y

COD. VF33.35D

COD. VF33.37S

VOLO A
B

Lampada led SPARK

SPARK led lighting

Ø 9,1
Sp Th 4,4

Interruttore manuale o sensore di luce azionabile con interruttore laterale. Applicabile con le viti fornite o con velcro biadesivo. 3 batterie da 1,5v AAA non incluse.

Manual switch or light sensor that can be operated with the side switch. Applied with the provided screws or with biadhesive Velcro. 3 - 1.5v AAA batteries not included.



Lampada led SKY

SKY led lighting

H Ht 2,2
P Dpt 1,5
L W 17

Interruttore touch integrato. Applicabile con le viti fornite o con biadesivo. 3 batterie da 1,5v AAA non incluse.

Built-in touch switch. Applied with the provided screws or with biadhesive tape. 3 - 1.5v AAA batteries not included.

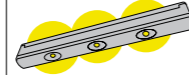

COD. VF32.59M

COD. VF32.60H



Letti a castello TITANO - H 179,3 L 200

TITANO bunk beds - Ht 179.3 W 200

- Letto superiore L 80 (per materasso L 80 P 190).
- Il letto superiore è utilizzabile anche senza rete.
- In fase di ordinazione è necessario aggiungere: una scaletta metallica o con fianchi sagomati, una o più protezioni.
- Retrofiniti, posizionabili anche a centro stanza.
- Volta colore Rovere white (RW3Q).

- Upper bed W 80 (for mattress W 80 Dpt 190).
- The upper bed can also be used without a bed base.
- When ordering, a metal ladder or the ladders with shaped sides and one or more guards have to be added.
- With finished back panel, can also be placed in centre of room.
- Hidden base support in Rovere white (RW3Q) colour.

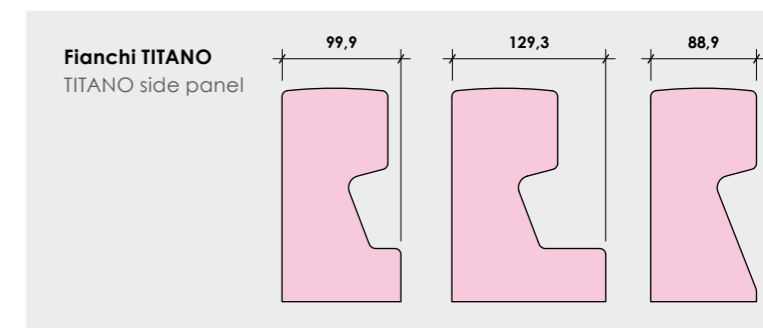

2 reti
2 bed bases

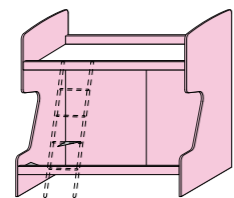

P Dpt **99,9**

COD. **VF05.40A**

Rete inferiore L 90 x 190
Bottom bed base W 90 x 190



Con rete estraibile
materasso L 80 H 17 max
With extractable bed base
mattress W 80 Ht 17 max

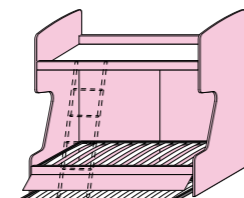

COD. **VF05.41G**

Con cassettoni
With big drawers

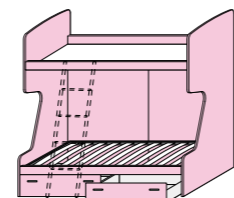

COD. **VF05.42P**

Vuoto
Empty

Vano L 195 H 183,2
Niche W 195 Ht 183.2

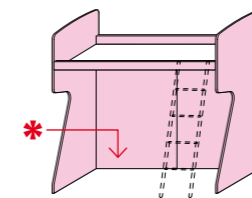

P Dpt **88,9**

COD. **VF05.55P**



con fissaggio
with fixing
L W 35
H Ht 148,7

PEG

scaletta in metallo
metal ladder

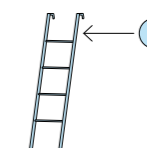

COD. **VF33.19U**

Specificare Sx o Dx
(disegni Dx)
Specify L or R
(drawings R)

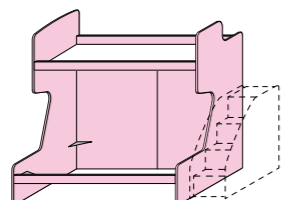

P Dpt **99,9**

COD. **VF05.45H**

Rete inferiore L 90 x 190
Bottom bed base W 90 x 190

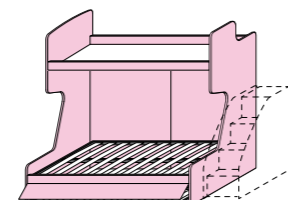

COD. **VF05.46Q**

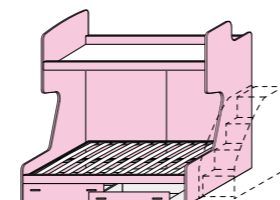

COD. **VF05.47W**

P Dpt **129,3**

COD. **VF05.50F**

Rete inferiore L 120 x 190
Bottom bed base W 120 x 190



COD. **VF05.51N**

COD. **VF05.52U**

Vano L 195 H 183,2
Niche W 195 Ht 183.2

Specificare Sx o Dx
(disegni Dx)
Specify L or R
(drawings R)

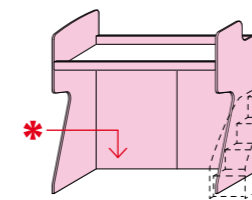

P Dpt **88,9**

COD. **VF05.56V**



con ante
with doors

L W 50
P Dpt 105,3
H Ht 120

LEA

scalette con fianchi sagomati
ladders with shaped side panels

Specificare cerniera Sx o Dx
(disegno Sx)
Specify hinge L or R
(drawing L)

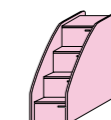

COD. **VF35.08R**

con ante e corrimano
with doors and handrail

L W 54
P Dpt 105,3
H Ht 184,3

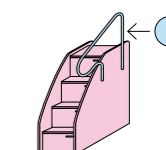

COD. **VF35.09X**

VOLO



Giroletti metallici *
Metal bed frames

L W 88
P Dpt 193
H Ht 29

Con 4 ruote piroettanti con freno
With 4 turning wheels with brake

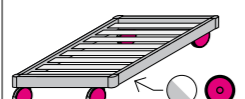

COD. **VF33.69W**

Con 4 piedi cilindrici trasparenti
With 4 transparent cylindrical feet

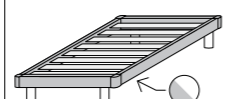

COD. **VF33.70T**

Corrimano per LEA
Handrail for LEA

Ø 3,2
P Dpt 92
H Ht 100

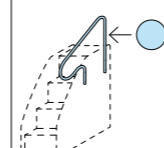

COD. **VF35.10U**

Protezioni (fisse) per scaletta PEG
Guards (fixed) for PEG ladder

MASCHERA
L W 150
H Ht 29

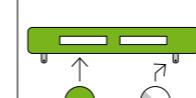

COD. **VF33.18N**



FLIP
L W 155
H Ht 26
Sp Ht 1,8

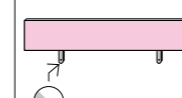

COD. **VF33.16Z**

WINNER
L W 150
H Ht 35
Sp Ht 2,5

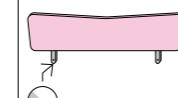

COD. **VF33.17F**

Protezioni (fisse) per scaletta LEA
Guards (fixed) for LEA ladder

MASCHERA
L W 183
H Ht 29

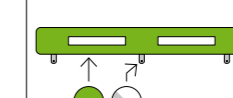

COD. **VF33.23L**

FLIP
L W 190
H Ht 26
Sp Ht 1,8

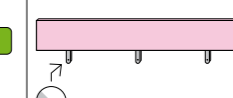

COD. **VF33.21X**

WINNER
L W 189
H Ht 35
Sp Ht 2,5

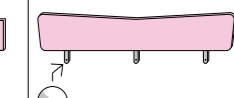

COD. **VF33.22D**



pag. 40
pag. 141
pag. 142

Posizionamento pomelli e maniglie
Knobs and handles position
Reti a doghe
Slatted bed bases
Materassi e guanciali
Mattresses and pillows

Facciate Fronts
VOLO

Finiture GRUPPO 1
GROUP 1 finishes

Finiture GRUPPO 2
GROUP 2 finishes

Rovere white*

Rovere white **RW3Q**

Rovere gesso **RG9L**

Ciliegio bianco **CB6K**

Grigio Dorian **GL4R**

Cemento antico **CA7A**

Rovere cognac **RC3Q**

Royal oak **RS4B**

Grigio titanio **GZ8T**

Oliva **LV5T**

Cadaques **CQ3Q**

Bianco opaco **B17A**

Giallo zafferano **GZ8A**

Albicocca **AB3C**

Orchidea **OR7L**

Blu Egeo **EG4L**

Vetri Glass

Ante Doors
WINDOW

Colori telaio
Frame colours

Trasparente **TR9M**

Trasparente fumé **FT8P**

Stop sol **ST6P**

Specchio **SP7L**

Alluminio **AL1A**

Titan grey **TG7H**

Rovere white* Finitura unica per tutti i componenti in pannello presenti a listino non evidenziati con il colore Finiture GRUPPO 1 e/o Finiture GRUPPO 2.
Unique finish for all the panel components shown in the pricelist not highlighted with the color finishes GROUP 1 and/or finishes GROUP 2.

- A** Finiture in fascia di prezzo A
Finishes in price range A
- B** Finiture in fascia di prezzo B
Finishes in price range B
- ☆ Finiture con effetto materico
Finishes with textured effect

LETTI E GRUPPI
BEDS AND GROUPS

Letti singoli Single beds	pag. 114
Letti singoli imbottiti Padded single beds	pag. 122
Turche Ottomans	pag. 124
Divani letto Sofa beds	pag. 126
Letti matrimoniali Double beds	pag. 128
Letti matrimoniali imbottiti Padded double beds	pag. 136
Letti scorrevoli NEW ROLL NEW ROLL sliding beds	pag. 138
Letti scorrevoli EDGE EDGE sliding beds	pag. 139
Accessori per letti Beds accessories	pag. 140
Reti a doghe Slatted bed bases	pag. 141
Materassi e guanciali Mattresses and pillows	pag. 142
Gruppi Groups	pag. 146
Specchiere Mirrors	pag. 150

Tutte le misure sono espresse in centimetri; con tolleranza ± 2 cm per gli imbottiti.
I pesi massimi consigliati dei materassi per letti con rete alzante, sono indicati nella tabella a fianco.

All measurements are expressed in centimeters; with tolerance ± 2 cm for upholstered items.
The recommended maximum weights of mattresses for beds with lift-up bed base are shown in the table alongside.

Larghezza rete alzante Lifting bed base width	Peso max materasso Max mattress weight
80 - 90	20 Kg
120	30 Kg
160	40 Kg



Con testata e pediera
With headboard and footboard

Con due reti
With two bed bases

Con rete e cassettoni
With bed base and big drawers

Con rete rialzabile
With lifting base

Con giroletto legno
With wooden bed frame

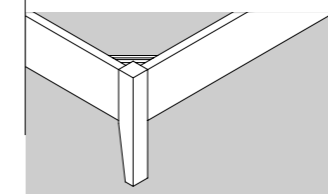

MANNY

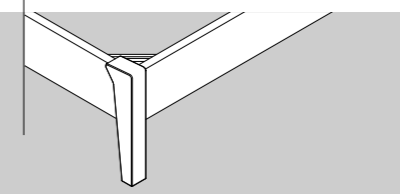

START

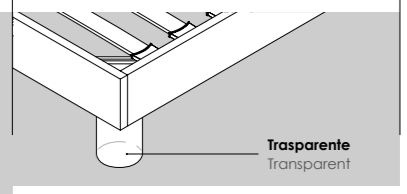

Trasparente
Transparent

BANNER

Sp Th 1,8

H Ht 90
P Dpt 195,6
205,6
L W 91
101
131

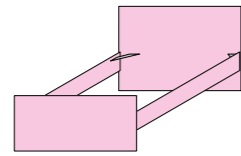

H Ht 90
P Dpt 198,6
-
L W 91
101
131

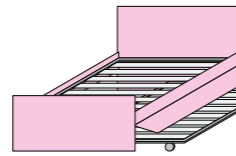

H Ht 90
P Dpt 198,6
-
L W 91
101
131

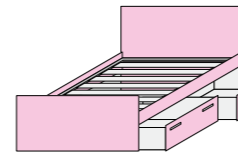

H Ht 90
P Dpt 200,6
-
L W 101
131

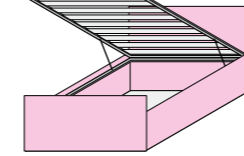

H Ht 90
P Dpt 198,8
208,8
L W 91
101
131

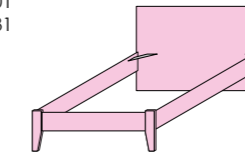

H Ht 90
P Dpt 198,8
208,8
L W 91
101
131

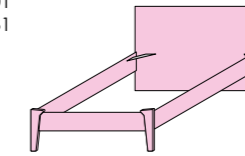

H Ht 90
P Dpt 198,8
208,8
L W 91
101
131

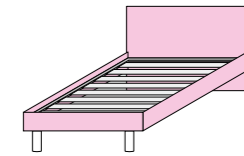

H Ht 90
P Dpt 198,6
-
L W 91
101
131

rete L bed base W	COD.	interno letto internal dimensions	COD.	interno letto internal dimensions	COD.	interno letto internal dimensions	COD.	interno letto internal dimensions	COD.	interno letto internal dimensions	COD.	interno letto internal dimensions	COD.	interno letto internal dimensions
80 x 190	VF20.00P	81,5 x 191	VF20.03H	81,5 x 194	VF20.06C	81,5 x 194	-	-	VF20.11A	81,5 x 191,5	VF20.14V	81,5 x 191,5	VF20.17Q	82,7 x 195
90 x 190 200	VF20.01V	91,5 x 191 91,5 x 201	VF20.04Q	91,5 x 194 -	VF20.07K	91,5 x 194 -	VF20.09X	91,5 x 195 -	VF20.12G	91,5 x 191,5 91,5 x 201,5	VF20.15B	91,5 x 191,5 91,5 x 201,5	VF20.18W	92,7 x 195 -
120 x 190 200	VF20.02B	121,5 x 191 121,5 x 201	VF20.05W	121,5 x 194 -	VF20.08R	121,5 x 194 -	VF20.10U	121,5 x 195 -	VF20.13P	121,5 x 191,5 121,5 x 201,5	VF20.16H	121,5 x 191,5 121,5 x 201,5	VF20.19C	122,1 x 195 -

EDGE

Sp Th 2,5

H Ht 120
P Dpt 197
207
L W 90
100
129,4

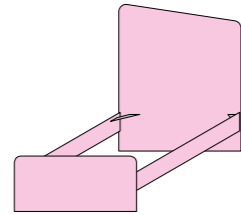

H Ht 120
P Dpt 200
-
L W 90
100
129,4

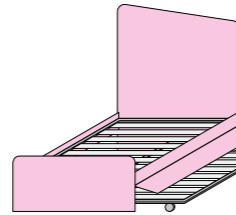

H Ht 120
P Dpt 200
-
L W 90
100
129,4

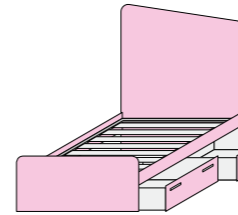

H Ht 120
P Dpt 202
-
L W 100
129,4

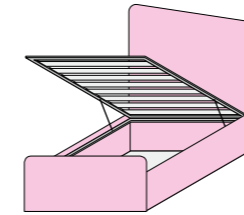

H Ht 120
P Dpt 199,5
209,5
L W 90
100
129,4

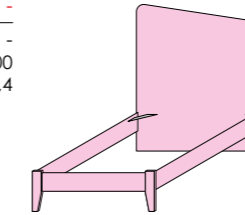

H Ht 120
P Dpt 199,5
209,5
L W 90
100
129,4

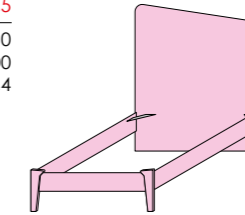

H Ht 120
P Dpt 199,5
209,5
L W 90
100
129,4

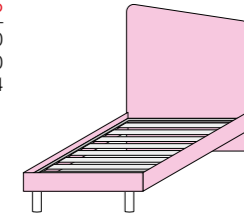

H Ht 120
P Dpt 199,3
-
L W 90
100
129,4

rete L bed base W	COD.	interno letto internal dimensions	COD.	interno letto internal dimensions	COD.	interno letto internal dimensions	COD.	interno letto internal dimensions	COD.	interno letto internal dimensions	COD.	interno letto internal dimensions	COD.	interno letto internal dimensions
80 x 190	VF20.20Z	81,5 x 191	VF20.23U	81,5 x 194	VF20.26P	81,5 x 194	-	-	VF20.31M	81,5 x 191,5	VF20.34F	81,5 x 191,5	VF20.37A	82,7 x 195
90 x 190 200	VF20.21F	91,5 x 191 91,5 x 201	VF20.24A	91,5 x 194 -	VF20.27V	91,5 x 194 -	VF20.29H	91,5 x 195 -	VF20.32T	91,5 x 191,5 91,5 x 201,5	VF20.35N	91,5 x 191,5 91,5 x 201,5	VF20.38G	92,7 x 195 -
120 x 190 200	VF20.22N	121,5 x 191 121,5 x 201	VF20.25G	121,5 x 194 -	VF20.28B	121,5 x 194 -	VF20.30E	121,5 x 195 -	VF20.33Z	121,5 x 191,5 121,5 x 201,5	VF20.36U	121,5 x 191,5 121,5 x 201,5	VF20.39P	122,1 x 195 -

EDGE PLUS

Sp Th 2,5

Mensole L 30 P 26
Shelves W 30 Dpt 26

H Ht 120
P Dpt 197
207
L W 120
130
159,4

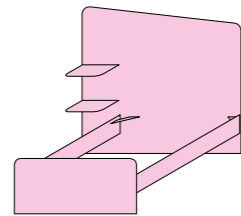

H Ht 120
P Dpt 200
-
L W 120
130
159,4

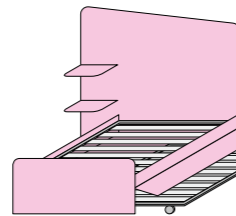

H Ht 120
P Dpt 200
-
L W 120
130
159,4

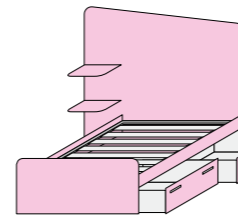

H Ht 120
P Dpt 202
-
L W 130
159,4

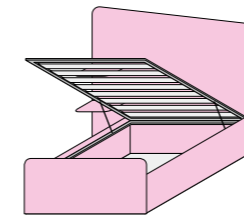

H Ht 120
P Dpt 199,5
209,5
L W 120
130
159,4

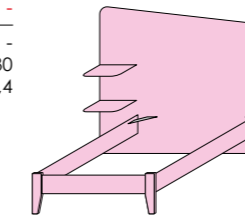

H Ht 120
P Dpt 199,5
209,5
L W 120
130
159,4

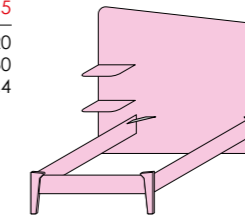

H Ht 120
P Dpt 199,5
209,5
L W 120
130
159,4

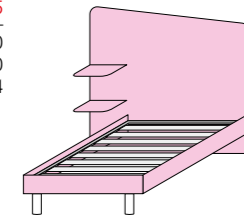

H Ht 120
P Dpt 199,3
-
L W 120
130
159,4

rete L bed base W	COD.	interno letto internal dimensions	COD.	interno letto internal dimensions	COD.	interno letto internal dimensions	COD.	interno letto internal dimensions	COD.	interno letto internal dimensions	COD.	interno letto internal dimensions	COD.	interno letto internal dimensions
80 x 190	VF20.40L	81,5 x 191	VF20.43E	81,5 x 194	VF20.46Z	81,5 x 194	-	-	VF20.51X	81,5 x 191,5	VF20.54S	81,5 x 191,5	VF20.57M	82,7 x 195
90 x 190 200	VF20.41S	91,5 x 191 91,5 x 201	VF20.44M	91,5 x 194 -	VF20.47F	91,5 x 194 -	VF20.49U	91,5 x 195 -	VF20.52D	91,5 x 191,5 91,5 x 201,5	VF20.55Y	91,5 x 191,5 91,5 x 201,5	VF20.58T	92,7 x 195 -
120 x 190 200	VF20.42Y	121,5 x 191 121,5 x 201	VF20.45T	121,5 x 194 -	VF20.48N	121,5 x 194 -	VF20.50R	121,5 x 195 -	VF20.53L	121,5 x 191,5 121,5 x 201,5	VF20.56E	121,5 x 191,5 121,5 x 201,5	VF20.59Z	122,1 x 195 -

In fase d'ordine specificare per rete P 190 o 200.
When ordering, specify for bed base Dpt 190 or 200.



Con testata e pediera
With headboard and footboard

Con due reti
With two bed bases

Con rete e cassettoni
With bed base and big drawers

Con rete rialzabile
With lifting base

Con giroletto legno
With wooden bed frame

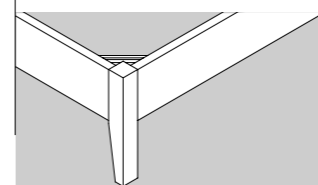

MANNY

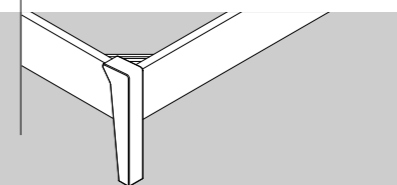

START

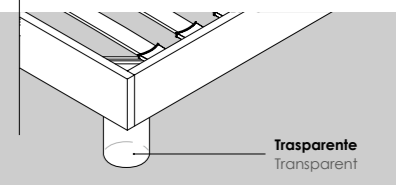

FOLDER

Sp Th 2,5 →

H Ht 85
P Dpt 197
207
L W 91
101
131

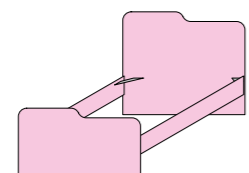

H Ht 85
P Dpt 200
-
L W 91
101
131

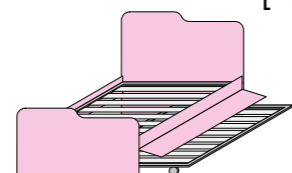

H Ht 85
P Dpt 200
-
L W 91
101
131

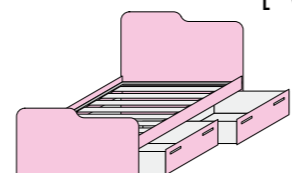

H Ht 85
P Dpt 202
-
L W 101
131

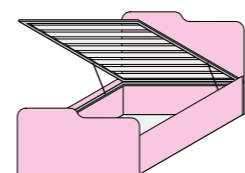

H Ht 85
P Dpt 199,5
209,5
L W 91
101
131

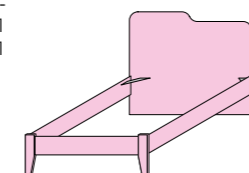

H Ht 85
P Dpt 199,5
209,5
L W 91
101
131

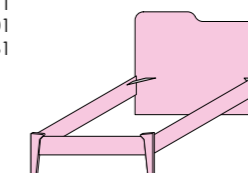

H Ht 85
P Dpt 199,5
209,5
L W 91
101
131

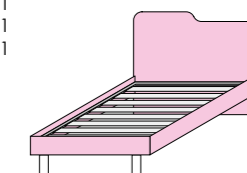

H Ht 85
P Dpt 199,3
-
L W 91
101
131

rete L bed base W	COD.	interno letto internal dimensions	COD.	interno letto internal dimensions	COD.	interno letto internal dimensions	COD.	interno letto internal dimensions	COD.	interno letto internal dimensions	COD.	interno letto internal dimensions	COD.	interno letto internal dimensions
80 x 190	VF20.60W	81,5 x 191	VF20.63R	81,5 x 194	VF20.66L	81,5 x 194	-	-	VF20.71H	81,5 x 191,5	VF20.74C	81,5 x 191,5	VF20.77X	82,7 x 195
90 x 190 200	VF20.61C	91,5 x 191 91,5 x 201	VF20.64X	91,5 x 194 -	VF20.67S	91,5 x 194 -	VF20.69E	91,5 x 195 -	VF20.72Q	91,5 x 191,5 91,5 x 201,5	VF20.75K	91,5 x 191,5 91,5 x 201,5	VF20.78D	92,7 x 195 -
120 x 190 200	VF20.62K	121,5 x 191 121,5 x 201	VF20.65D	121,5 x 194 -	VF20.68Y	121,5 x 194 -	VF20.70B	121,5 x 195 -	VF20.73W	121,5 x 191,5 121,5 x 201,5	VF20.76R	121,5 x 191,5 121,5 x 201,5	VF20.79L	122,1 x 195 -

SERVER

Sp Th 2,5 →

H Ht 87,4
P Dpt 197
207
L W 98
108
137,4

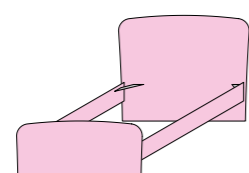

H Ht 87,4
P Dpt 200
-
L W 98
108
137,4

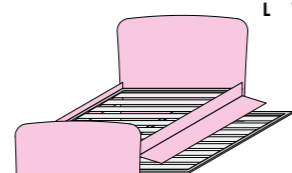

H Ht 87,4
P Dpt 200
-
L W 98
108
137,4

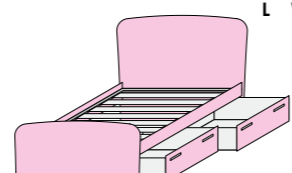

H Ht 87,4
P Dpt 202
-
L W 108
137,4

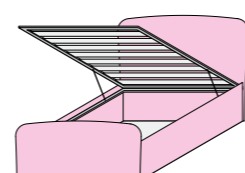

H Ht 87,4
P Dpt 199,5
209,5
L W 98
108
137,4

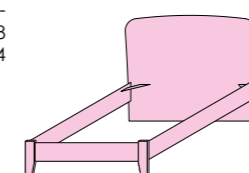

H Ht 87,4
P Dpt 199,5
209,5
L W 98
108
137,4

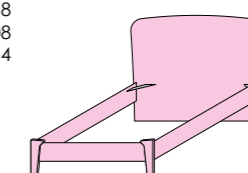

H Ht 87,4
P Dpt 199,5
209,5
L W 98
108
137,4

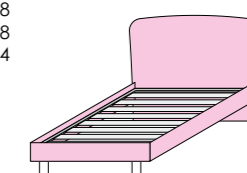

H Ht 87,4
P Dpt 199,3
-
L W 98
108
137,4

rete L bed base W	COD.	interno letto internal dimensions	COD.	interno letto internal dimensions	COD.	interno letto internal dimensions	COD.	interno letto internal dimensions	COD.	interno letto internal dimensions	COD.	interno letto internal dimensions	COD.	interno letto internal dimensions
80 x 190	VF20.80G	81,5 x 191	VF20.83B	81,5 x 194	VF20.86W	81,5 x 194	-	-	VF20.91U	81,5 x 191,5	VF20.94P	81,5 x 191,5	VF20.97H	82,7 x 195
90 x 190 200	VF20.81P	91,5 x 191 91,5 x 201	VF20.84H	91,5 x 194 -	VF20.87C	91,5 x 194 -	VF20.89R	91,5 x 195 -	VF20.92A	91,5 x 191,5 91,5 x 201,5	VF20.95V	91,5 x 191,5 91,5 x 201,5	VF20.98Q	92,7 x 195 -
120 x 190 200	VF20.82V	121,5 x 191 121,5 x 201	VF20.85Q	121,5 x 194 -	VF20.88K	121,5 x 194 -	VF20.90N	121,5 x 195 -	VF20.93G	121,5 x 191,5 121,5 x 201,5	VF20.96B	121,5 x 191,5 121,5 x 201,5	VF20.99W	122,1 x 195 -

SPLIT

Sp Th 2,5 →

H Ht 110
P Dpt 197
207
L W 90
100
129,4

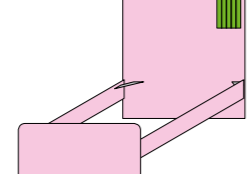

H Ht 110
P Dpt 200
-
L W 90
100
129,4

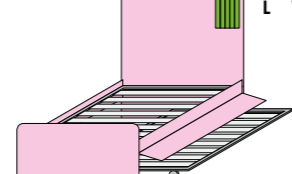

H Ht 110
P Dpt 200
-
L W 90
100
129,4

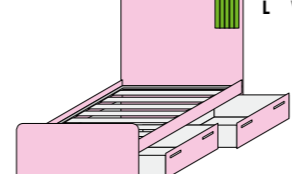

H Ht 110
P Dpt 202
-
L W 100
129,4

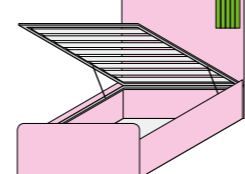

H Ht 110
P Dpt 199,5
209,5
L W 90
100
129,4

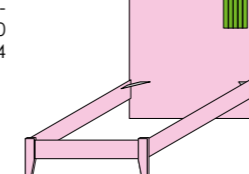

H Ht 110
P Dpt 199,5
209,5
L W 90
100
129,4

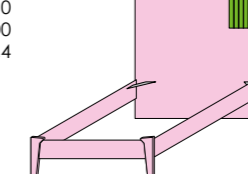

H Ht 110
P Dpt 199,5
209,5
L W 90
100
129,4

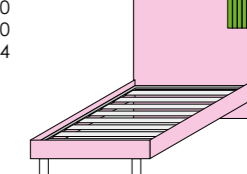

H Ht 110
P Dpt 199,3
-
L W 90
100
129,4

rete L bed base W	COD.	interno letto internal dimensions	COD.	interno letto internal dimensions	COD.	interno letto internal dimensions	COD.	interno letto internal dimensions	COD.	interno letto internal dimensions	COD.	interno letto internal dimensions	COD.	interno letto internal dimensions
80 x 190	VF23.00B	81,5 x 191	VF23.03W	81,5 x 194	VF23.06R	81,5 x 194	-	-	VF23.11P	81,5 x 191,5	VF23.14H	81,5 x 191,5	VF23.17C	82,7 x 195
90 x 190 200	VF23.01H	91,5 x 191 91,5 x 201	VF23.04C	91,5 x 194 -	VF23.07X	91,5 x 194 -	VF23.09L	91,5 x 195 -	VF23.12V	91,5 x 191,5 91,5 x 201,5	VF23.15Q	91,5 x 191,5 91,5 x 201,5	VF23.18K	92,7 x 195 -
120 x 190 200	VF23.02Q	121,5 x 191 121,5 x 201	VF23.05K	121,5 x 194 -	VF23.08D	121,5 x 194 -	VF23.10G	121,5 x 195 -	VF23.13B	121,5 x 191,5 121,5 x 201,5	VF23.16W	121,5 x 191,5 121,5 x 201,5	VF23.19R	122,1 x 195 -



In fase d'ordine specificare per rete P 190 o 200.
When ordering, specify for bed base Dpt 190 or 200.

pag. 40
pag. 140
pag. 141
pag. 142

Posizionamento pomelli e maniglie
Knobs and handles position
Accessori per letti
Beds accessories
Reti a doghe
Slatted bed bases
Materassi e guanciali
Mattresses and pillows



Con testata e pediera
With headboard and footboard

Con due reti
With two bed bases

Con rete e cassettoni
With bed base and big drawers

Con rete rialzabile
With lifting base

Con giroletto legno
With wooden bed frame

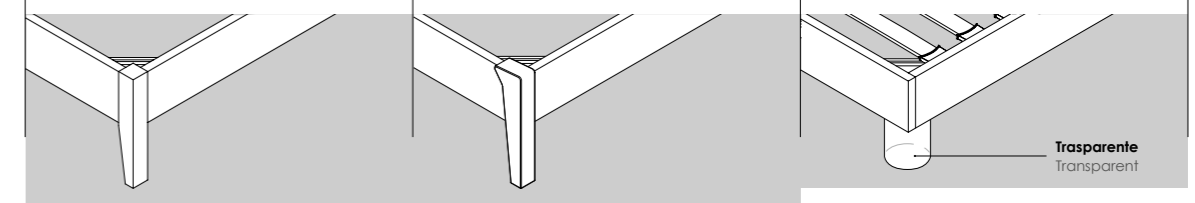

START

Sp Th 1,8

H Ht 31,8
P Dpt 198,6
L W 86,3
96,3
125,7

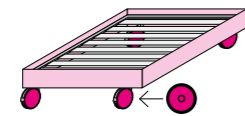

H Ht 31,8
P Dpt 198,6
L W 86,3
96,3
125,7

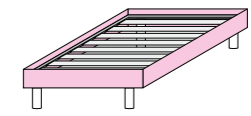

rete L bed base W	COD.	interno letto internal dimensions	COD.	interno letto internal dimensions
80 x 190	VF21.00T	81,5 x 191	VF21.03N	82,7 x 195
90 x 190 200	VF21.01Z	91,5 x 191	VF21.04U	92,7 x 195
120 x 190 200	VF21.02F	121,5 x 191	VF21.05A	122,1 x 195

SUNRISE

Sp Th 4,3

La testata può essere bicolore a discrezione del cliente
On own discretion headboard can be two-colored

Specificare Sx o Dx (disegni Sx)
Specify L or R (drawings L)

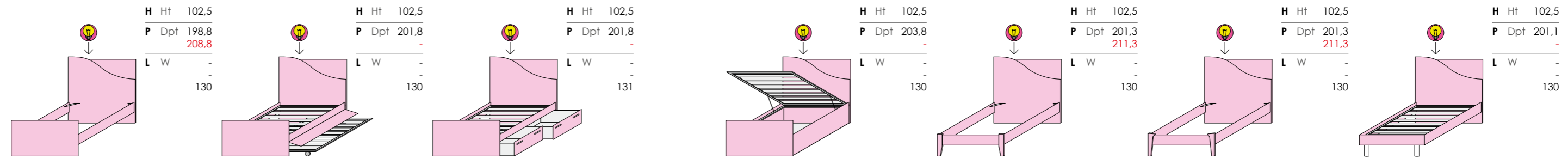

rete L bed base W	COD.	interno letto internal dimensions	COD.	interno letto internal dimensions	COD.	interno letto internal dimensions	COD.	interno letto internal dimensions	COD.	interno letto internal dimensions	COD.	interno letto internal dimensions	COD.	interno letto internal dimensions
80 x 190	-	-	-	-	-	-	-	-	-	-	-	-	-	-
90 x 190 200	-	-	-	-	-	-	-	-	-	-	-	-	-	-
120 x 190 200	VF21.06G	121,5 x 191 121,5 x 201	VF21.07P	121,5 x 194	VF21.08V	121,5 x 194	VF21.09B	121,5 x 195	VF21.10Y	121,5 x 191,5 121,5 x 201,5	VF21.11E	121,5 x 191,5 121,5 x 201,5	VF21.12M	122,1 x 195

TULIP

Sp Th 2,5

La testata può essere bicolore a discrezione del cliente
On own discretion headboard can be two-colored

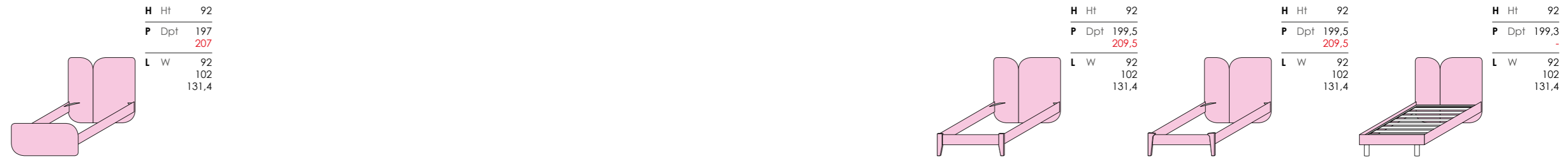

rete L bed base W	COD.	interno letto internal dimensions	COD.	interno letto internal dimensions	COD.	interno letto internal dimensions	COD.	interno letto internal dimensions
80 x 190	VF21.13T	81,5 x 191	VF21.16N	81,5 x 191,5	VF21.19G	81,5 x 191,5	VF21.22S	82,7 x 195
90 x 190 200	VF21.14Z	91,5 x 191 91,5 x 201	VF21.17U	91,5 x 191,5 91,5 x 201,5	VF21.20D	91,5 x 191,5 91,5 x 201,5	VF21.23Y	92,7 x 195
120 x 190 200	VF21.15F	121,5 x 191 121,5 x 201	VF21.18A	121,5 x 191,5 121,5 x 201,5	VF21.21L	121,5 x 191,5 121,5 x 201,5	VF21.24E	122,1 x 195



pag. 40
pag. 140
pag. 141
pag. 142

Posizionamento pomelli e maniglie
Knobs and handles position
Accessori per letti
Beds accessories
Reti a doghe
Slatted bed bases
Materassi e guanciali
Mattresses and pillows

In fase d'ordine specificare per rete P 190 o 200.
When ordering, specify for bed base Dpt 190 or 200.

Letti singoli

Single beds

Con testata e pediera
With headboard and footboard

Con due reti
With two bed bases

Con rete e cassettoni
With bed base and big drawers

Con rete rialzabile
With lifting base

Con giroletto legno
With wooden bed frame

NETTUNO

MANNY

START

Trasparente
Transparent

VELO

Sp Th 2,5
La testata può essere bicolore a discrezione del cliente
On own discretion headboard can be two-colored

H Ht 92
P Dpt 197
207
L W 90
100
129,4

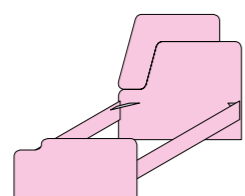

H Ht 92
P Dpt 200
-
L W 90
100
129,4

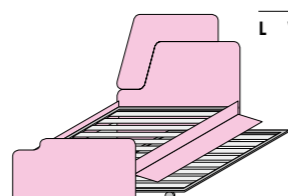

H Ht 92
P Dpt 200
-
L W 90
100
129,4

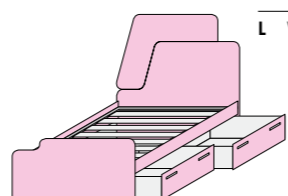

H Ht 92
P Dpt 202
-
L W 90
100
129,4

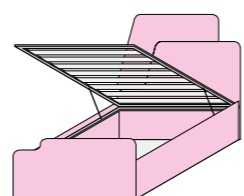

H Ht 92
P Dpt 199,5
209,5
L W 90
100
129,4

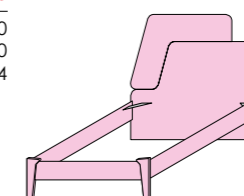
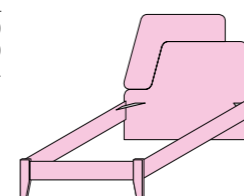

H Ht 92
P Dpt 199,5
209,5
L W 90
100
129,4

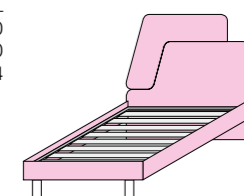

H Ht 92
P Dpt 199,3
-
L W 90
100
129,4

rete L bed base W	COD.	interno letto internal dimensions	COD.	interno letto internal dimensions	COD.	interno letto internal dimensions	COD.	interno letto internal dimensions	COD.	interno letto internal dimensions	COD.	interno letto internal dimensions
80 x 190	VF21.25M	81,5 x 191	VF21.28F	81,5 x 194	VF21.31R	81,5 x 194	-	-	VF21.36Y	81,5 x 191,5	VF21.39T	81,5 x 191,5
90 x 190 200	VF21.26T	91,5 x 191 91,5 x 201	VF21.29N	91,5 x 194 -	VF21.32X	91,5 x 194 -	VF21.34L	91,5 x 195 -	VF21.37E	91,5 x 191,5 91,5 x 201,5	VF21.40Q	91,5 x 191,5 91,5 x 201,5
120 x 190 200	VF21.27Z	121,5 x 191 121,5 x 201	VF21.30K	121,5 x 194 -	VF21.33D	121,5 x 194 -	VF21.35S	121,5 x 195 -	VF21.38M	121,5 x 191,5 121,5 x 201,5	VF21.41W	121,5 x 191,5 121,5 x 201,5
											VF21.42C	82,7 x 195
											VF21.43K	92,7 x 195 -
											VF21.44R	122,1 x 195 -

WINNER

Sp Th 2,5

H Ht 90
P Dpt 197
207
L W 95
105
134

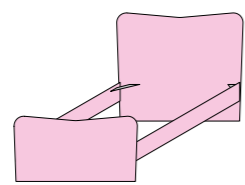

H Ht 90
P Dpt 202
-
L W 105
134

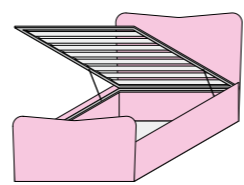

H Ht 90
P Dpt 199,5
209,5
L W 95
105
134

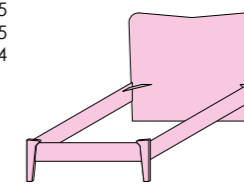
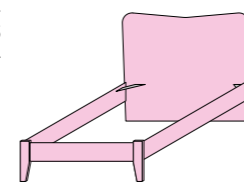

H Ht 90
P Dpt 199,5
209,5
L W 95
105
134

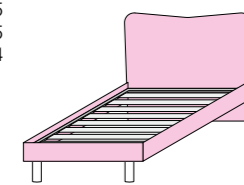

H Ht 90
P Dpt 199,3
-
L W 95
105
134

rete L bed base W	COD.	interno letto internal dimensions	COD.	interno letto internal dimensions	COD.	interno letto internal dimensions	COD.	interno letto internal dimensions	COD.	interno letto internal dimensions
80 x 190	VF21.45X	81,5 x 191			-	-	VF21.50V	81,5 x 191,5	VF21.53Q	81,5 x 191,5
90 x 190 200	VF21.46D	91,5 x 191 91,5 x 201			VF21.48S	91,5 x 195 -	VF21.51B	91,5 x 191,5 91,5 x 201,5	VF21.54W	91,5 x 191,5 91,5 x 201,5
120 x 190 200	VF21.47L	121,5 x 191 121,5 x 201			VF21.49Y	121,5 x 195 -	VF21.52H	121,5 x 191,5 121,5 x 201,5	VF21.55C	121,5 x 191,5 121,5 x 201,5
									VF21.56K	82,7 x 195
									VF21.57R	92,7 x 195 -
									VF21.58X	122,1 x 195 -

Giroletto metallico

Beds with metal frame

H Ht 29

Con 4 ruote piroettanti con freno
With 4 turning wheels with brake

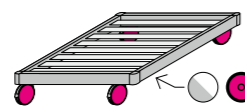

Con 4 piedi cilindrici trasparenti
With 4 transparent cylindrical feet

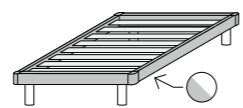

rete L bed base W	COD.	interno letto internal dimensions	COD.	interno letto internal dimensions
88 x 193	VF33.69W	84 x 189	VF33.70T	84 x 189
98 x 193	VF33.82M	94 x 189	VF33.84Z	94 x 189
127,4 x 193	VF33.83T	124 x 189	VF33.85F	124 x 189

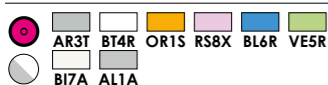

In fase d'ordine specificare per rete P 190 o 200.
When ordering, specify for bed base Dpt 190 or 200.

pag. 40
pag. 140
pag. 141
pag. 142

Posizionamento pomelli e maniglie
Knobs and handles position
Accessori per letti
Beds accessories
Reti a doghe
Slatted bed bases
Materassi e guanciali
Mattresses and pillows

Letti singoli imbottiti

Padded single beds

Con rete fissa
With fixed base

Con rete rialzabile
With lifting base

Vano contenitore:
H 20 - P 195 - L 92/122
Space inside container:
Ht 20 - Dpt 195 - W 92/122

Con rete fissa
With fixed base

Con rete rialzabile
With lifting base

Vano contenitore:
H 20 - P 195 - L 92/122
Space inside container:
Ht 20 - Dpt 195 - W 92/122

GALAXY

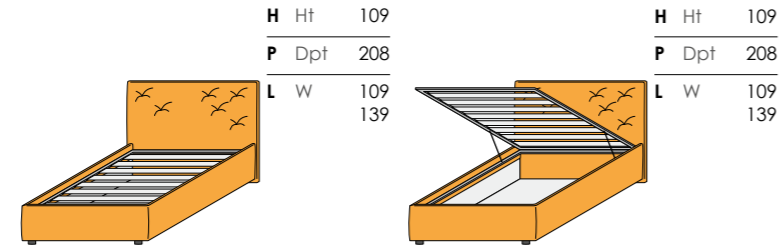

rete L bed base W	COD.	interno letto internal dimensions	COD.	interno letto internal dimensions
90	VF21.60A	92 x 195	VF21.62P	90 x 190
120	VF21.61G	122 x 195	VF21.63V	120 x 190

TWIN

Sfoderabili
Removable covers

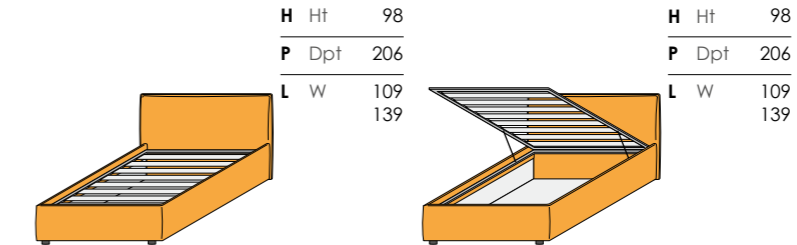

rete L bed base W	COD.	interno letto internal dimensions	COD.	interno letto internal dimensions
90	VF21.76V	92 x 195	VF21.78H	90 x 190
120	VF21.77B	122 x 195	VF21.79Q	120 x 190

GALLERY

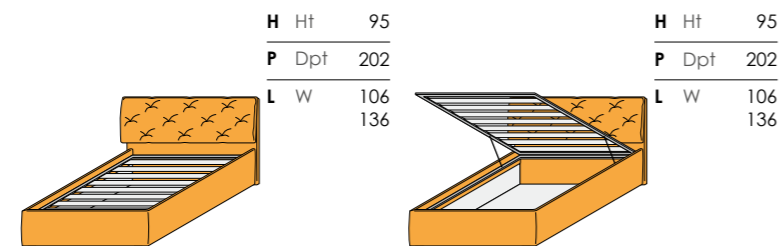

rete L bed base W	COD.	interno letto internal dimensions	COD.	interno letto internal dimensions
90	VF21.64B	92 x 195	VF21.66Q	90 x 190
120	VF21.65H	122 x 195	VF21.67W	120 x 190

KANT

Sfoderabili
Removable covers

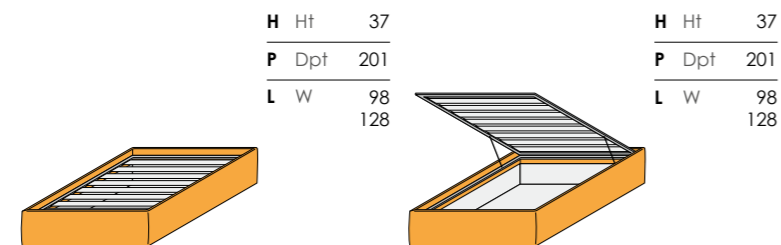

rete L bed base W	COD.	interno letto internal dimensions	COD.	interno letto internal dimensions
90	VF21.68C	92 x 195	VF21.70F	90 x 190
120	VF21.69K	122 x 195	VF21.71N	120 x 190

RAPSODY

Le testate del letto prevedono:
versione L 90 - 2 cuciture verticali equidistanti,
versione L 120 - 3 cuciture verticali equidistanti.
The headboards of the bed include:
W 90 version - 2 equidistant vertical seams,
W 120 version - 3 equidistant vertical seams.

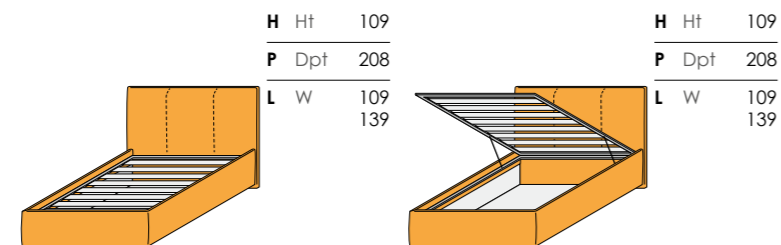

rete L bed base W	COD.	interno letto internal dimensions	COD.	interno letto internal dimensions
90	VF21.72U	92 x 195	VF21.74G	90 x 190
120	VF21.73A	122 x 195	VF21.75P	120 x 190

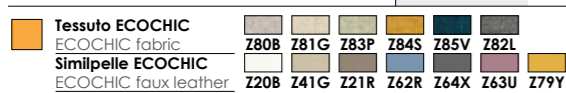

pag. 140
pag. 142

Accessori per letti
Beds accessories
Materassi e guanciali
Mattresses and pillows

Con testata e pediera
With headboard and footboard

Con due reti
With two bed bases

Con rete e cassettoni
With bed base and big drawers

Con rete rialzabile
With lifting base

Vano contenitore:
H 19,5 - P 195 - L 83
Space inside container:
Ht 19,5 - Dpt 195 - W 83

Per rete estraibile materasso L 80 H 17 max.
Mattress W 80 Ht 17 cm max for pull-out bed base.

BANNER

Sp Th 1,8

H Ht 45
P Dpt 195,6
L W 91

H Ht 45
P Dpt 198,6
L W 91

H Ht 45
P Dpt 198,6
L W 91

H Ht 45
P Dpt 198,6
L W 91

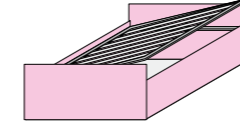
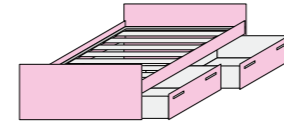
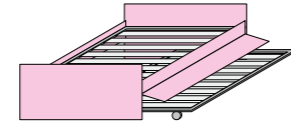
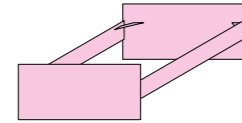

rete L bed base W	COD.	interno letto internal dimensions	COD.	interno letto internal dimensions	COD.	interno letto internal dimensions	COD.	interno letto internal dimensions
80	VF21.80M	81,5 x 191	VF21.81T	81,5 x 194	VF21.82Z	81,5 x 194	VF21.83F	81,5 x 194

FOLDER

Sp Th 2,5

H Ht 55,3
P Dpt 197
L W 91

H Ht 55,3
P Dpt 200
L W 91

H Ht 55,3
P Dpt 200
L W 91

H Ht 55,3
P Dpt 200
L W 91

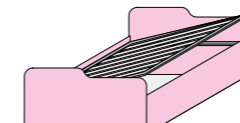
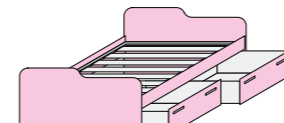
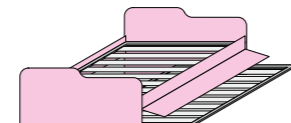
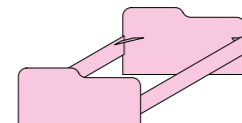

rete L bed base W	COD.	interno letto internal dimensions	COD.	interno letto internal dimensions	COD.	interno letto internal dimensions	COD.	interno letto internal dimensions
80	VF21.84N	81,5 x 191	VF21.85U	81,5 x 194	VF21.86A	81,5 x 194	VF21.87G	81,5 x 194

SERVER

Sp Th 2,5

H Ht 50
P Dpt 197
L W 93,9

H Ht 50
P Dpt 200
L W 93,9

H Ht 50
P Dpt 200
L W 93,9

H Ht 50
P Dpt 200
L W 93,9

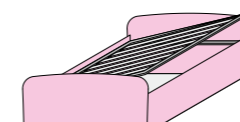
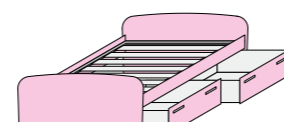
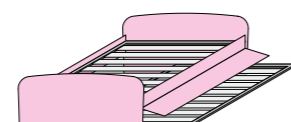
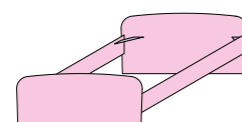

rete L bed base W	COD.	interno letto internal dimensions	COD.	interno letto internal dimensions	COD.	interno letto internal dimensions	COD.	interno letto internal dimensions
80	VF21.88P	81,5 x 191	VF21.89V	81,5 x 194	VF21.90S	81,5 x 194	VF21.91Y	81,5 x 194

Divani letto

Sofa beds

Con testata e pediera
With headboard and footboard

Con due reti
With two bed bases

Con rete e cassettoni
With bed base and big drawers

Per rete estraibile materasso L 80 H 12 max.
Mattress W 80 Ht 12 cm max for pull-out bed base.

FOLDER

Sp Th 2,5

H Ht 55,5
P Dpt 200
L W 91

H Ht 55,5
P Dpt 200
L W 91

H Ht 55,5
P Dpt 200
L W 91

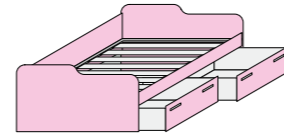
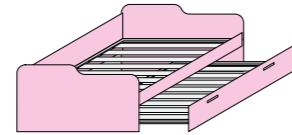
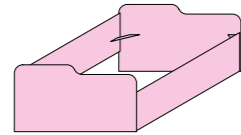

rete L bed base W	COD.	interno letto internal dimensions	COD.	interno letto internal dimensions	COD.	interno letto internal dimensions
80	VF21.97N	81,5 x 194	VF21.98U	81,5 x 194	VF21.99A	81,5 x 194

WINNER

Sp Th 2,5

H Ht 70,5
P Dpt 200
L W 93

H Ht 70,5
P Dpt 200
L W 93

H Ht 70,5
P Dpt 200
L W 93

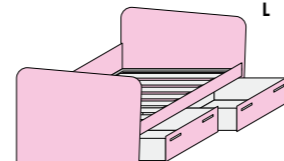
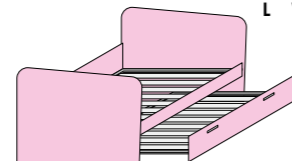
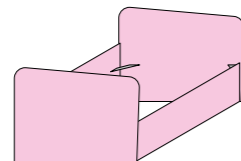

rete L bed base W	COD.	interno letto internal dimensions	COD.	interno letto internal dimensions	COD.	interno letto internal dimensions
80	VF22.01D	81,5 x 194	VF22.02L	81,5 x 194	VF22.03S	81,5 x 194

Accessori

Accessories

Coppia poggiaschiena in spugna
Pair of foam back cushions

L W 197
P Dpt 33
H Ht 35

L W 198
P Dpt 33,5
H Ht 36

grezzo
raw

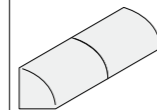
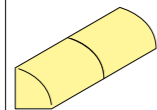

Fodera per poggiaschiena
Back cushions clothing cover

per coppia poggiaschiena in spugna
for pair of foam back cushions

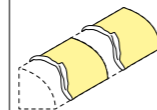

Materasso in spugna
Foam mattress

L W 81,5
P Dpt 189
H Ht 12

per rete inferiore estraibile
for pull-out lower base
con fodera
with cover

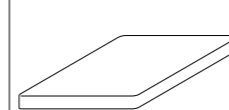

Copriletto con elastici
Bedspread with elastic

per materassi H 12 e H 17
for mattress Ht 12 and Ht 17

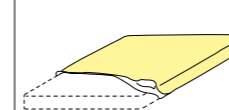

Tessuto in cotone
Cotton fabric

H Ht 140

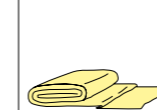

Tessuto JENNY (RV24JN)
JENNY fabric (RV24JN) 0402 0403 0503 0903 0706 0704 0601 0604

pag. 40
pag. 141
pag. 142

Posizionamento pomelli e maniglie
Knobs and handles position
Reti a doghe
Slatted bed bases
Materassi e guanciali
Mattresses and pillows



Con testata e pediera
With headboard and footboard

Con rete rialzabile
With lifting base

Con giroletto legno
With wooden bed frame
NETTUNO

MANNY

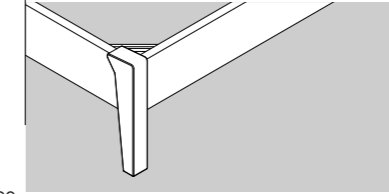
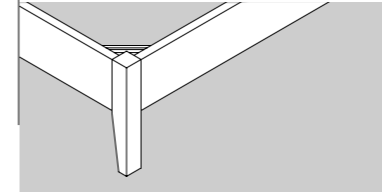

BANNER

Sp Th 1,8 →

H Ht 90
P Dpt 195,6
205,6
L W 170

H Ht 90
P Dpt 198,8
208,8
L W 170

H Ht 90
P Dpt 198,8
208,8
L W 170

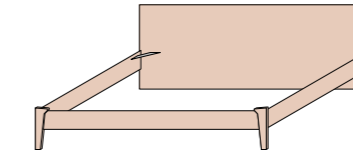
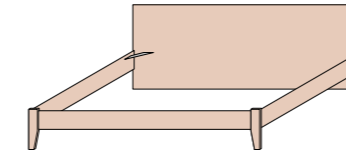
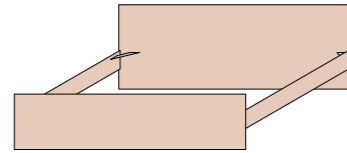

rete L bed base W	COD.	interno letto internal dimensions	COD.	interno letto internal dimensions	COD.	interno letto internal dimensions
190	VF22.05E	161,5 x 191	VF22.06M	161,5 x 191,5	VF22.07T	161,5 x 191,5
160 x 200		161,5 x 201		161,5 x 201,5		161,5 x 201,5

BENT

Sp Th 2,5 →

La testata può essere bicolore a discrezione del cliente
On own discretion headboard can be two-colored

H Ht 105,6
P Dpt 203,2
213,2
L W 180

H Ht 105,6
P Dpt 208,2
218,2
L W 180

H Ht 105,6
P Dpt 205,7
215,7
L W 180

H Ht 105,6
P Dpt 205,7
215,7
L W 180

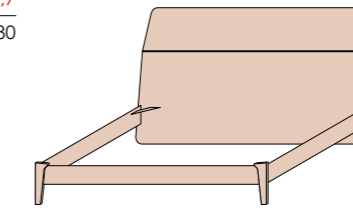
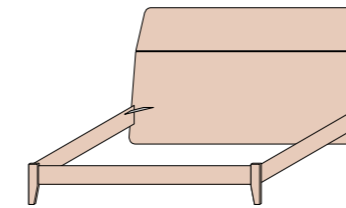
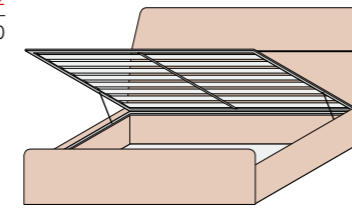
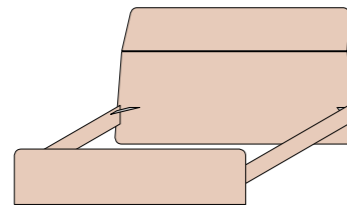

rete L bed base W	COD.	interno letto internal dimensions	COD.	interno letto internal dimensions	COD.	interno letto internal dimensions
190	VF22.54A	161,5 x 191	VF22.55G	161,5 x 195	VF22.56P	161,5 x 191,5
160 x 200		161,5 x 201		161,5 x 205		161,5 x 201,5

EDGE

Sp Th 2,5 →

H Ht 120
P Dpt 197
207
L W 170

H Ht 120
P Dpt 202
212
L W 170

H Ht 120
P Dpt 199,5
209,5
L W 170

H Ht 120
P Dpt 199,5
209,5
L W 170

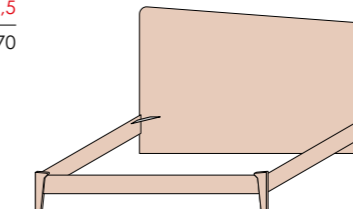
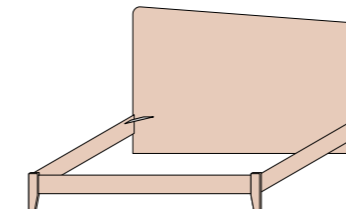
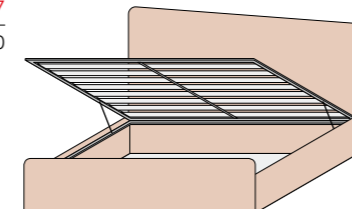
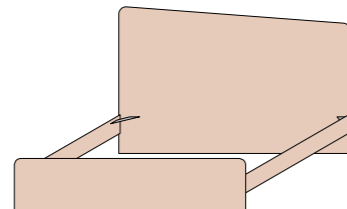

rete L bed base W	COD.	interno letto internal dimensions	COD.	interno letto internal dimensions	COD.	interno letto internal dimensions
190	VF22.08Z	161,5 x 191	VF22.09F	161,5 x 195	VF22.10C	161,5 x 191,5
160 x 200		161,5 x 201		161,5 x 205		161,5 x 201,5

In fase d'ordine specificare per rete P 190 o 200.
When ordering, specify for bed base Dpt 190 or 200.

pag. 140
pag. 141
pag. 142

Accessori per letti
Beds accessories
Reti a doghe
Slatted bed bases
Matressi e guanciali
Mattresses and pillows



Con testata e pediera
With headboard and footboard

Con rete rialzabile
With lifting base

Con giroletto legno
With wooden bed frame
NETTUNO

MANNY

EDGE PLUS

Sp Th 2,5
Mensole L 30 P 26
Shelves W 30 Dpt 26

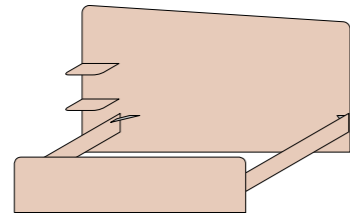

H Ht 120
P Dpt 197
207
L W 200

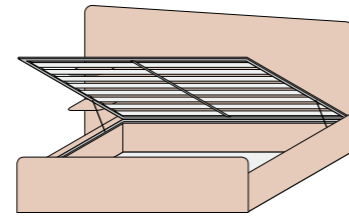

H Ht 120
P Dpt 202
212
L W 200

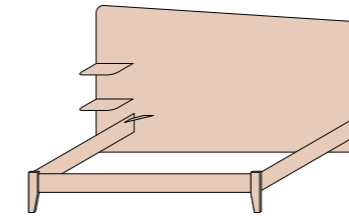

H Ht 120
P Dpt 199,5
209,5
L W 200

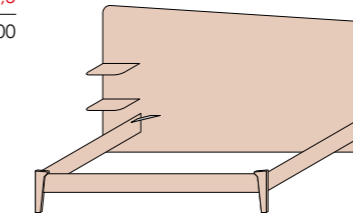

H Ht 120
P Dpt 199,5
209,5
L W 200

rete L bed base W	COD.	interno letto internal dimensions	COD.	interno letto internal dimensions	COD.	interno letto internal dimensions	COD.	interno letto internal dimensions
190	VF22.12R	161,5 x 191	VF22.13X	161,5 x 195	VF22.14D	161,5 x 191,5	VF22.15L	161,5 x 191,5
160 x 200		161,5 x 201		161,5 x 205		161,5 x 201,5		161,5 x 201,5

FOLDER

Sp Th 2,5

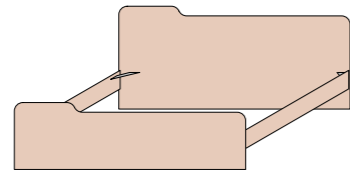

H Ht 98
P Dpt 197
207
L W 171

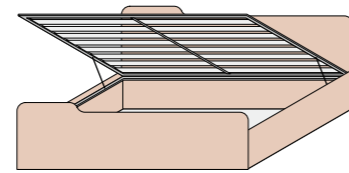

H Ht 98
P Dpt 202
212
L W 171

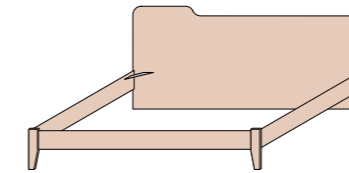

H Ht 98
P Dpt 199,5
209,5
L W 171

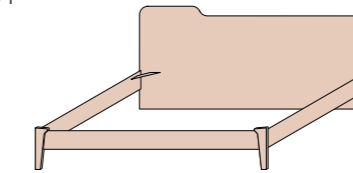

H Ht 98
P Dpt 199,5
209,5
L W 171

rete L bed base W	COD.	interno letto internal dimensions	COD.	interno letto internal dimensions	COD.	interno letto internal dimensions	COD.	interno letto internal dimensions
190	VF22.16S	161,5 x 191	VF22.17Y	161,5 x 195	VF22.18E	161,5 x 191,5	VF22.19M	161,5 x 191,5
160 x 200		161,5 x 201		161,5 x 205		161,5 x 201,5		161,5 x 201,5

SERVER

Sp Th 2,5

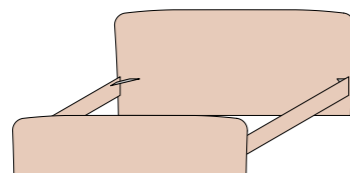

H Ht 88
P Dpt 197
207
L W 178

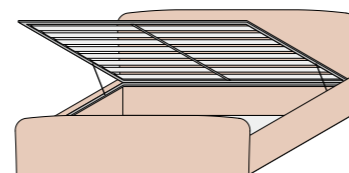

H Ht 88
P Dpt 202
212
L W 178

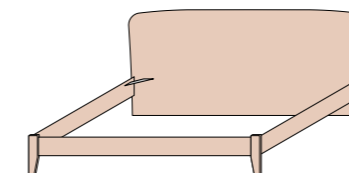

H Ht 88
P Dpt 199,5
209,5
L W 178

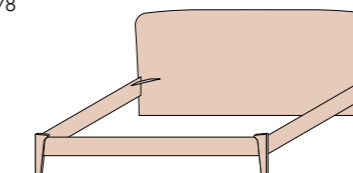

H Ht 88
P Dpt 199,5
209,5
L W 178

rete L bed base W	COD.	interno letto internal dimensions	COD.	interno letto internal dimensions	COD.	interno letto internal dimensions	COD.	interno letto internal dimensions
190	VF22.20H	161,5 x 191	VF22.21Q	161,5 x 195	VF22.22W	161,5 x 191,5	VF22.23C	161,5 x 191,5
160 x 200		161,5 x 201		161,5 x 205		161,5 x 201,5		161,5 x 201,5

In fase d'ordine specificare per rete P 190 o 200.
When ordering, specify for bed base Dpt 190 or 200.

pag. 140
pag. 141
pag. 142

Accessori per letti
Beds accessories
Reti a doghe
Slatted bed bases
Materassi e guanciali
Mattresses and pillows



SPLIT

Sp Th 2,5

Con testata e pediera
With headboard and footboard

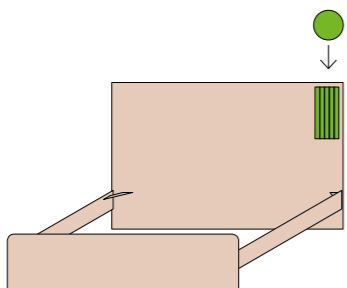

Con rete rialzabile
With lifting base

Vano contenitore:
H 19,5 - P 197/207 - L 163
Space inside container:
Ht 19,5 - Dpt 197/207 - W 163

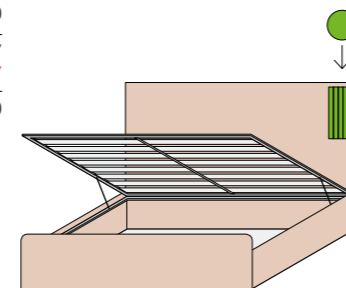

Con giroletto legno
With wooden bed frame

NETTUNO

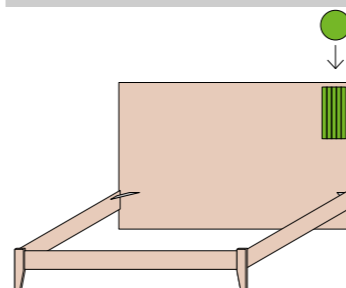

MANNY

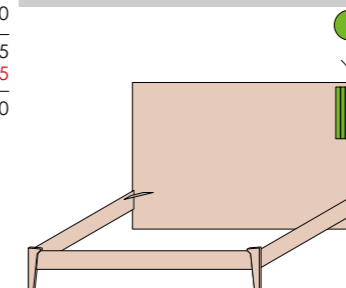

rete L bed base W	COD.	interno letto internal dimensions	COD.	interno letto internal dimensions	COD.	interno letto internal dimensions	COD.	interno letto internal dimensions
190	VF23.20N	161,5 x 191	VF23.21U	161,5 x 195	VF23.22A	161,5 x 191,5	VF23.23G	161,5 x 191,5
200		161,5 x 201		161,5 x 205		161,5 x 201,5		161,5 x 201,5

SUNRISE

Sp Th 4,3

La testata può essere bicolore a discrezione del cliente
On own discretion headboard can be two-colored
Specificare Sx o Dx (disegni Sx)
Specify L or R (drawings L)

Con testata e pediera

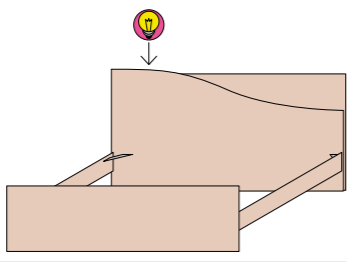

Con rete rialzabile

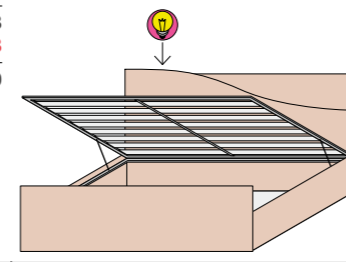

Con giroletto legno

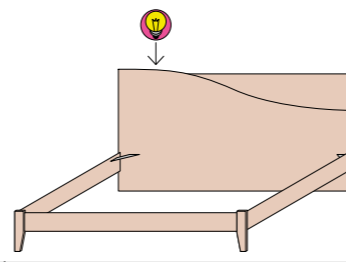

MANNY

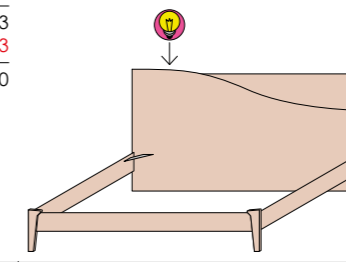

rete L bed base W	COD.	interno letto internal dimensions	COD.	interno letto internal dimensions	COD.	interno letto internal dimensions	COD.	interno letto internal dimensions
190	VF22.24K	161,5 x 191	VF22.25R	161,5 x 195	VF22.26X	161,5 x 191,5	VF22.27D	161,5 x 191,5
200		161,5 x 201		161,5 x 205		161,5 x 201,5		161,5 x 201,5

TULIP

Sp Th 2,5

La testata può essere bicolore a discrezione del cliente
On own discretion headboard can be two-colored

Con testata e pediera

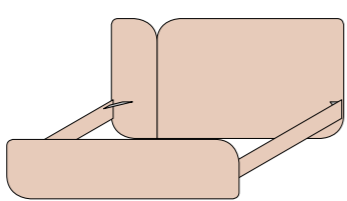

Con rete rialzabile



Con giroletto legno

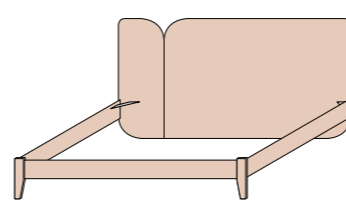

MANNY

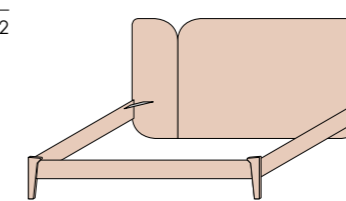

rete L bed base W	COD.	interno letto internal dimensions	COD.	interno letto internal dimensions	COD.	interno letto internal dimensions
190	VF22.28L	161,5 x 191	VF22.29S	161,5 x 191,5	VF22.30P	161,5 x 191,5
200		161,5 x 201		161,5 x 201,5		161,5 x 201,5

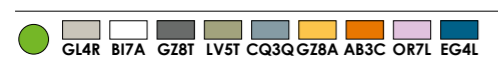

In fase d'ordine specificare per rete P 190 o 200.
When ordering, specify for bed base Dpt 190 or 200.

pag. 140 Accessori per letti
Beds accessories
pag. 141 Reti a doghe
Slatted bed bases
pag. 142 Materassi e guanciali
Mattresses and pillows

Letti matrimoniali

Double beds

Con testata e pediera
With headboard and footboard

Con rete rialzabile
With lifting base

Con giroletto legno
With wooden bed frame

MANNY

VELO

Sp Th 2,5 →

La testata può essere bicolore a discrezione del cliente
On own discretion headboard can be two-colored

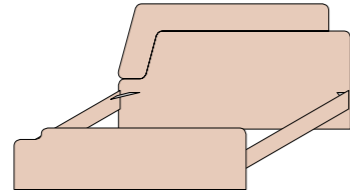

H Ht 92
P Dpt 197
207
L W 170

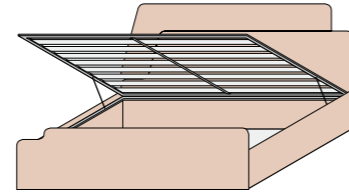

H Ht 92
P Dpt 202
212
L W 170

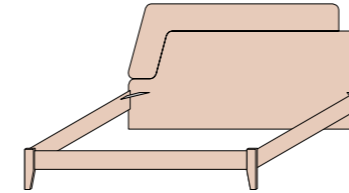

H Ht 92
P Dpt 199,5
209,5
L W 170

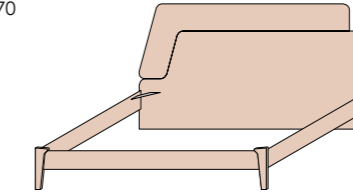

H Ht 92
P Dpt 199,5
209,5
L W 170

rete L bed base W	COD.	interno letto internal dimensions	COD.	interno letto internal dimensions	COD.	interno letto internal dimensions	COD.	interno letto internal dimensions
190	VF22.31V	161,5 x 191	VF22.32B	161,5 x 195	VF22.33H	161,5 x 191,5	VF22.34Q	161,5 x 191,5
160 x 200		161,5 x 201		161,5 x 205		161,5 x 201,5		161,5 x 201,5

WINNER

Sp Th 2,5 →

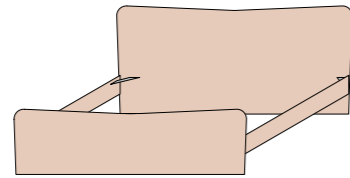

H Ht 90
P Dpt 197
207
L W 175

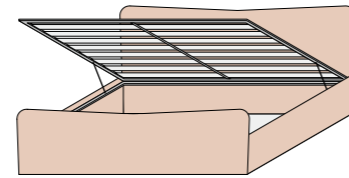

H Ht 90
P Dpt 202
212
L W 175

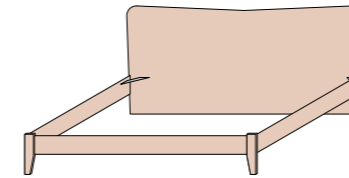

H Ht 90
P Dpt 199,5
209,5
L W 175

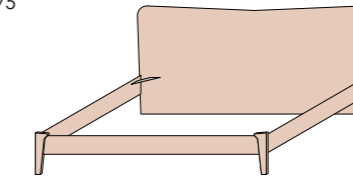

H Ht 90
P Dpt 199,5
209,5
L W 175

rete L bed base W	COD.	interno letto internal dimensions	COD.	interno letto internal dimensions	COD.	interno letto internal dimensions	COD.	interno letto internal dimensions
190	VF22.35W	161,5 x 191	VF22.36C	161,5 x 195	VF22.37K	161,5 x 191,5	VF22.38R	161,5 x 191,5
160 x 200		161,5 x 201		161,5 x 205		161,5 x 201,5		161,5 x 201,5

In fase d'ordine specificare per rete P 190 o 200.
When ordering, specify for bed base Dpt 190 or 200.

Letti matrimoniali imbottiti

Padded double beds

Con rete fissa
With fixed base

Con rete rialzabile
With lifting base

Vano contenitore:
H 20 - P 195 - L 162
Space inside container:
Ht 20 - Dpt 195 - W 162

Con rete rialzabile
With lifting base

Vano contenitore:
H 20 - P 195 - L 162
Space inside container:
Ht 20 - Dpt 195 - W 162

GALAXY

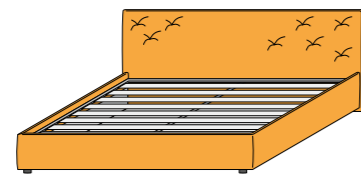

H Ht 109
P Dpt 208
L W 179

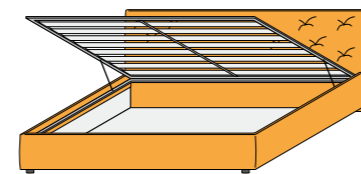

H Ht 109
P Dpt 208
L W 179

rete L bed base W 160	COD. VF22.39X	interno letto internal dimensions 162 x 195	COD. VF22.40U	interno letto internal dimensions 160 x 190
------------------------------------	--------------------------------	---	--------------------------------	---

TWIN

Sfoderabili
Removable covers

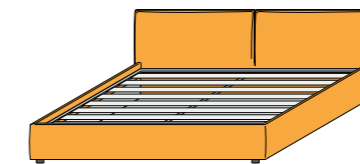

H Ht 98
P Dpt 206
L W 179

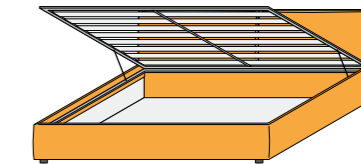

H Ht 98
P Dpt 206
L W 179

rete L bed base W 160	COD. VF22.49C	interno letto internal dimensions 162 x 195	COD. VF22.50Z	interno letto internal dimensions 160 x 190
------------------------------------	--------------------------------	---	--------------------------------	---

GALLERY

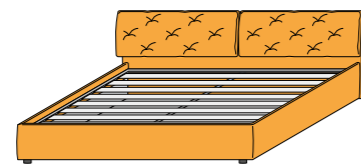

H Ht 95
P Dpt 202
L W 176

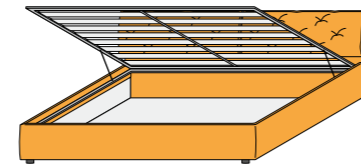

H Ht 95
P Dpt 202
L W 176

rete L bed base W 160	COD. VF22.41A	interno letto internal dimensions 162 x 195	COD. VF22.42G	interno letto internal dimensions 160 x 190
------------------------------------	--------------------------------	---	--------------------------------	---

KANT

Sfoderabili
Removable covers

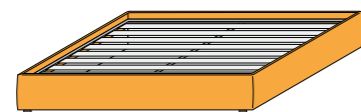

Ht 37
P Dpt 201
L W 168

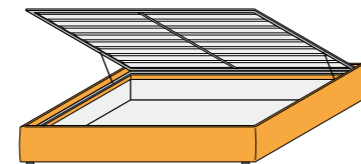

H Ht 37
P Dpt 201
L W 168

rete L bed base W 160	COD. VF22.43P	interno letto internal dimensions 162 x 195	COD. VF22.44V	interno letto internal dimensions 160 x 190
------------------------------------	--------------------------------	---	--------------------------------	---

RAPSODY

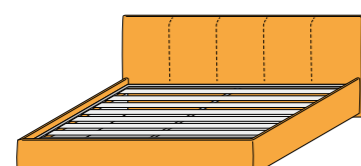

H Ht 109
P Dpt 208
L W 179

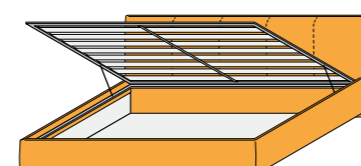

H Ht 109
P Dpt 208
L W 179

rete L bed base W 160	COD. VF22.47Q	interno letto internal dimensions 162 x 195	COD. VF22.48W	interno letto internal dimensions 160 x 190
------------------------------------	--------------------------------	---	--------------------------------	---

Tessuto ECOCHIC ECOCHIC fabric	Z80B	Z81G	Z83P	Z84S	Z85V	Z82L
Similpelle ECOCHIC ECOCHIC faux leather	Z20B	Z41G	Z21R	Z62R	Z64X	Z63U Z79Y

pag. 140
pag. 142

Accessori per letti
Beds accessories
Materassi e guanciali
Mattresses and pillows

Letti scorrevoli NEW ROLL

NEW ROLL sliding beds

Letti scorrevoli EDGE

EDGE sliding beds

Informazioni tecniche:
Technical information:

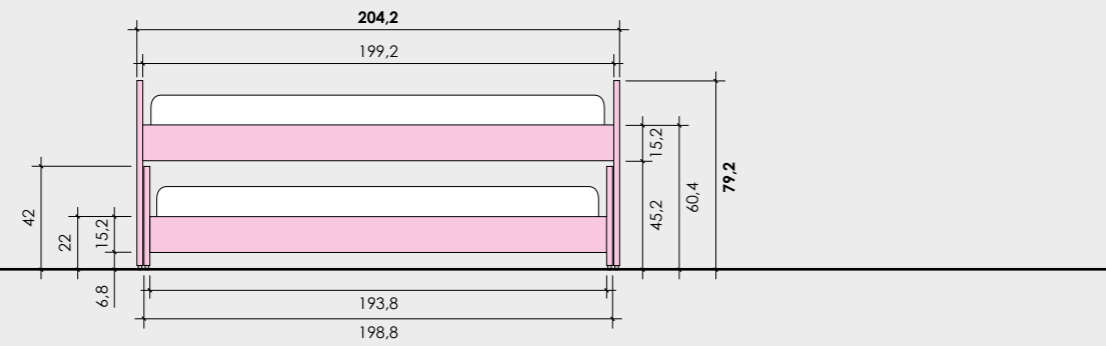

Informazioni tecniche:
Technical information:

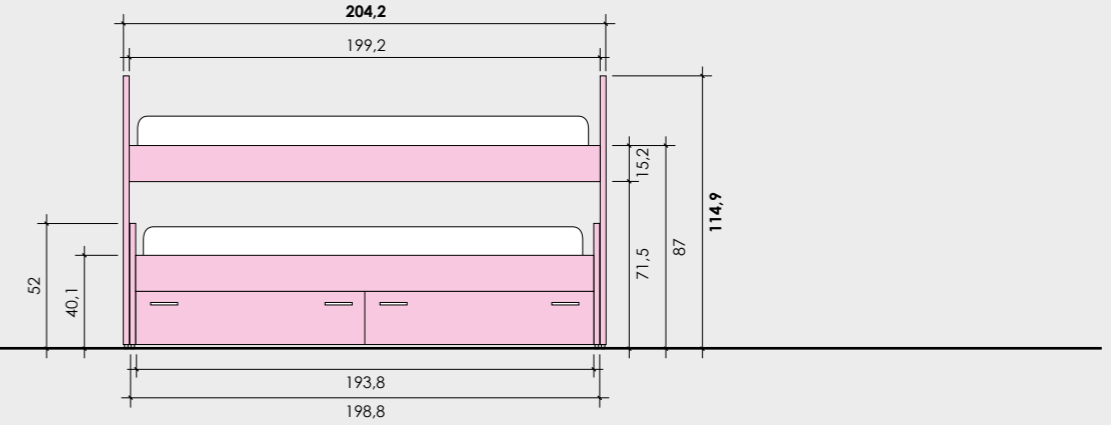

Letti scorrevoli con ruote autofrenanti.
Sliding beds with self-braking wheels.

Coppia letti
Pair of beds

H	Ht	79,2
P	Dpt	204,2
L	W	89,8

Letto superiore
Higher bed

H	Ht	79,2
P	Dpt	204,2
L	W	89,8

Letto inferiore
Lower bed

H	Ht	42
P	Dpt	198,8
L	W	89,8

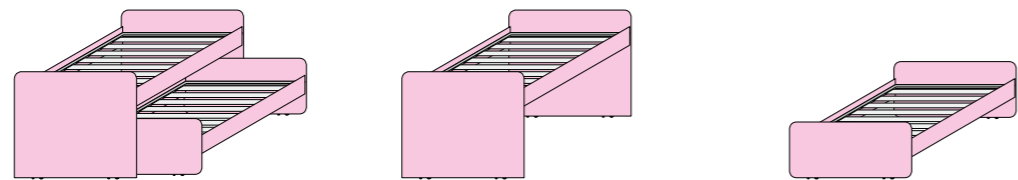

reti L bed bases W	COD.	COD.	interno letto internal dimensions	COD.	interno letto internal dimensions
80 x 190	VF22.51F	VF22.52N	198,2 x 79,9	VF22.53U	192,8 x 79,9

Letto superiore scorrevole con ruote autofrenanti.
Higher sliding bed with self-braking wheels.

H	Ht	114,9
P	Dpt	204,2
L	W	89,8

Utilizzabile anche senza rete
Can also be used without a net

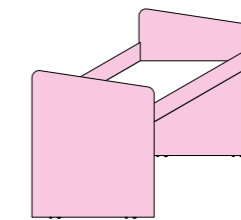

reti L bed bases W	COD.
80 x 190	VF22.58B

Scaletta in metallo SHORT
SHORT metal ladder
con fissaggio
with fixing

L	W	35
H	Ht	88

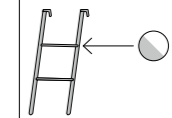

COD.	COD.
VF22.62T	

Letti inferiori scorrevoli con ruote autofrenanti.
Lower sliding beds with self-braking wheels.

H	Ht	52
P	Dpt	198,8
L	W	88,2

Per rete estraibile materasso
L 80 H 17 max.
Mattress W 80 Ht 17 cm max
for pull-out bed base.

H	Ht	52
P	Dpt	198,8
L	W	88,2

H	Ht	52
P	Dpt	198,8
L	W	88,2

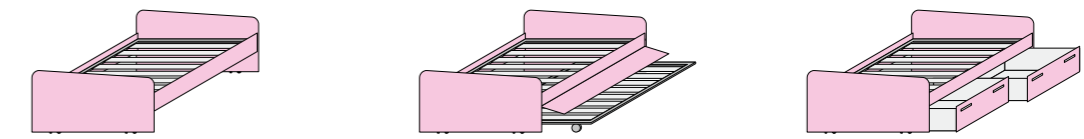

reti L bed bases W	COD.	interno letto internal dimensions	COD.	interno letto internal dimensions	COD.	interno letto internal dimensions
80 x 190	VF22.59H	198,2 x 79,9	VF22.60E	198,2 x 79,9	VF22.61M	192,8 x 79,9

Protezioni (fisse) per scaletta SHORT
Guards (fixed) for SHORT ladder

MASCHERA

L	W	150
H	Ht	29

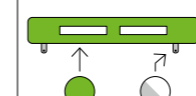

COD. VF33.18N

FLIP

L	W	155
H	Ht	26
Sp	Ht	1,8

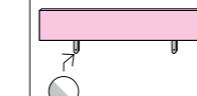

COD. VF33.16Z

WINNER

L	W	150
H	Ht	35
Sp	Ht	2,5

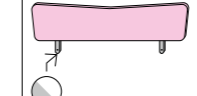

COD. VF33.17F

Protezioni (fisse)
Guards (fixed)

MASCHERA

L	W	183
H	Ht	29

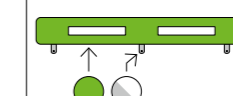

COD. VF33.23L

FLIP

L	W	190
H	Ht	26
Sp	Ht	1,8

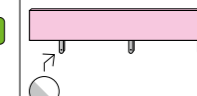

COD. VF33.21X

WINNER

L	W	189
H	Ht	35
Sp	Ht	2,5

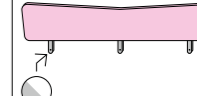

COD. VF33.22D

Protezioni non obbligatorie secondo la normativa vigente in tema di sicurezza.
Guards not obligatory in accordance with the safety regulation in force.

pag. 40
pag. 141
pag. 142

Posizionamento pomelli e maniglie
Knobs and handles position
Reti a doghe
Slatted bed bases
Materassi e guanciali
Mattresses and pillows

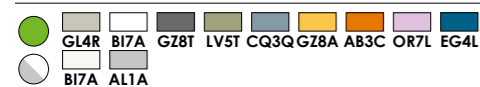

Accessori per letti

Beds accessories

Sponde su misura

Customized side panels

Rete a cura del cliente.
In fase d'ordine è indispensabile indicare L della rete.
Base to be supplied by the customer.
When ordering, you must state the width of base.

senza piastre
per rete con piedi
without plates
for base with feet

H Ht 15,2
Sp Th 2,5

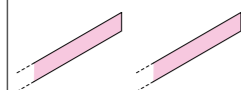

con piastre
per rete senza piedi
with plates
for base without feet

H Ht 15,2
Sp Th 2,5

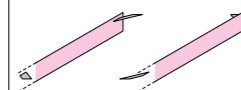

L W		COD.		COD.	
95÷230	A	VF33.92S		VF33.93Y	
	B				

Fodere di rivestimento in tessuto o similpelle

Fabric and faux leather covers

Per letti con rete
fissa e rialzabile
For beds with
fixed and lifting base

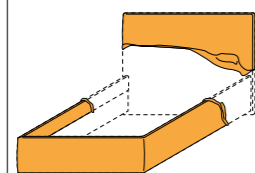

L W		COD.	
90	KANT	VF33.94E	
	TWIN	VF33.95M	
120	KANT	VF33.96T	
	TWIN	VF33.97Z	
160	KANT	VF33.98F	
	TWIN	VF33.99N	

Kit illuminazione led per testate letti.

Led lighting kit
for bed headboards.

Fascia led L 120, 1 interruttore, cablaggi
Led strip W 120, 1 switch, wiring

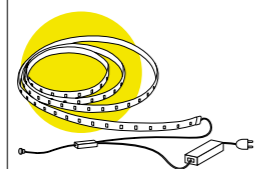

COD.	VF34.00K
------	----------

Tessuto ECOCHIC
ECOCHIC fabric
Z80B Z81G Z83P Z84S Z85V Z82L
Similpelle ECOCHIC
ECOCHIC faux leather
Z20B Z41G Z21R Z62R Z64X Z63U Z79Y

Reti a doghe

Slatted bed bases

TUBOLARE: tubolare 40 x 28 mm con traverse 30 x 30 ad alta resistenza.
DOGHE: doghe in betulla 68 x 8 mm.
VERNICIATURA: verniciatura polvere epossidica nera.

TUBULAR MEMBERS: 40 x 28 mm tubular members with high strength 30 x 30 cross bars.
SLATS: birch slats of 68x8 mm.
PAINTING: black epoxy powder painted finish.

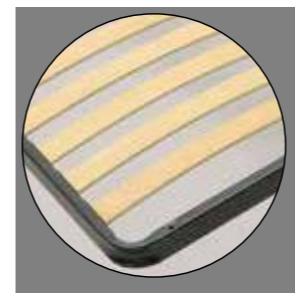

RETE SENZA PIEDI BASE WITHOUT FEET		RETE SENZA PIEDI BASE WITHOUT FEET	
P Dpt	190	P Dpt	200
L W	COD.	L W	COD.
80	VF33.66B	80	-
90	VF34.18S	90	VF35.15B
120	VF34.19Y	120	VF35.16H
160	VF34.20V	160	VF34.21B

RETE ESTRAIBILE CON RUOTE (CON PIEDI PIEGHEVOLI) PULL-OUT BASE WITH WHEELS (WITH FOLDABLE FEET)		RETE CON PIEDI (PIEGHEVOLI) BASE WITH FEET (FOLDABLE)	
P Dpt	190	P Dpt	190
L W	COD.	L W	COD.
80	VF34.22H	80	VF34.23Q
		90	VF34.24W

RETE CON PIEDI (SMONTABILI) BASE WITH FEET (REMOVABLE)		RETE CON PIEDI (SMONTABILI) BASE WITH FEET (REMOVABLE)	
P Dpt	190	P Dpt	200
L W	COD.	L W	COD.
120	VF34.25C	120	-
160	VF34.26K	160	VF34.27R

Reti a doghe avvolgibile

Roll-up slatted base

L W 80
P Dpt 190



COD.	VF33.20R
------	----------

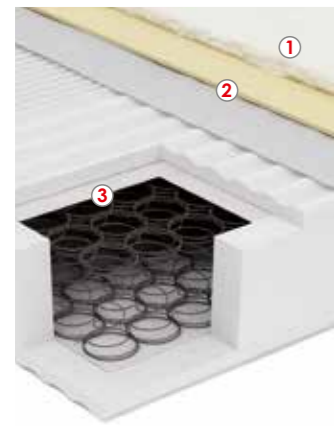

CAPRI

400 MOLLE BICONICHE BONNELL 400 BONNELL HOURGLASS SPRINGS

1 TESSUTO: Elasticizzato con trattamento anallergico. Fisso. **2 IMBOTTITURA:** Lato invernale: Fibra PolyFill Termal (lana selezionata + fibra poliestere anallergica). Lato estivo: Fibra PolyFill Fresh (cotone selezionato + fibra poliestere anallergica). **3 STRUTTURA:** Molle biconiche Bonnell "400" (densità circa 400 molle, nella versione matrimoniale) + poliuretano alto spessore con profilo sagomato. **PORTANZA:** Rigido. **SPESORE:** H cm. 21 ca: con maniglie. H cm. 17 ca: senza maniglie.

1 FABRIC: Stretch with anti-allergy treatment. Fixed. **2 UPHOLSTERY:** Winter side: PolyFill Thermal fibre (high grade wool + anti-allergy polyester fibre). Summer side: PolyFill Fresh fibre (high grade cotton + anti-allergy polyester fibre). **3 STRUCTURE:** Bonnell "400" hourglass springs (density approximately 400 springs in the Double version) + thick polyurethane with shaped profile. **RIGIDITY:** Firm. **THICKNESS:** Ht 21 cm approx. with handles. Ht 21 cm approx. without handles.



H Ht	17	P Dpt	190		
L W	Kg	COD.			
80	11,5	VF33.39E			
90	12,9	VF33.71Z			

H Ht	21	P Dpt	190		
L W	Kg	COD.			
80	13	VF33.40B			
90	14,6	VF33.72F			
120	19,5	VF33.77P			
160	26	VF34.01R			
80	14	VF33.44C			
90	15,8	VF33.76G			
120	21	VF33.81E			
160	28	VF34.02X			

H Ht	21	P Dpt	200		
L W	Kg	COD.			
80	-	-			
90	15,4	VF33.45K			
120	20,5	VF33.50G			
160	27,4	VF34.03D			
80	-	-			
90	16,6	VF33.49L			
120	-	-			
160	29,5	VF34.04L			

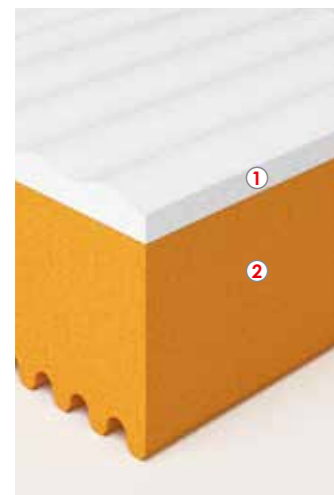

LIPARI

ECOFOAM (schiumato ad acqua, cellula aperta traspirante) ECOFOAM (water foamed, breathable open cell)

COVER: Sfoderabile e lavabile in acqua a 30°C. **TESSUTO:** Elasticizzato, trattamento anallergico e cerniera centrale su tre lati. **IMBOTTITURA:** 100% fibra Polyfill anallergica traspirante. **STRUTTURA:** 1 Strato di EcoFoam (poliuretano espanso a cellula aperta, schiumato ad acqua) con profilo multizona. 2 Strato in alto spessore in EcoFoam (poliuretano a cellula aperta, schiumato ad acqua) profilo ad ondine. **PORTANZA:** 1 Rigido. 2 Medio. **SPESORE:** H cm. 17 ca: (lastra spessore cm. 15,5 ca).

COVER: Covers can be removed and washed in water at 30°C. **FABRIC:** Stretch with anti-allergy treatment and central zip fastener on three sides. **UPHOLSTERY:** 100% breathable anti-allergy Polyfill fibre. **STRUCTURE:** 1 Layer of EcoFoam (water-foamed open-cell polyurethane foam) with multizone profile. 2 Thick layer of EcoFoam (water-foamed open-cell polyurethane) with wave profile. **RIGIDITY:** 1 Firm. 2 Medium. **THICKNESS:** Ht 17 cm approx. (main body 15.5 cm approx.).



H Ht	17	P Dpt	190		
L W	Kg	COD.			
80	8	VF33.41H			
90	9	VF33.73N			
120	12	VF33.78V			
160	16	VF34.05S			

H Ht	17	P Dpt	200		
L W	Kg	COD.			
80	-	-			
90	9,5	VF33.46R			
120	12,6	VF33.51P			
160	16,8	VF34.06Y			



ELBA

ECOFOAM + TERMO-VISCO MEMORY FOAM ECOFOAM + VISCO-ELASTIC MEMORY FOAM

COVER: Silver Air: tessuto anallergico con trattamento a base di argento, sfoderabile e lavabile in acqua 30°C. **TESSUTO:** Elasticizzato trattamento Silver Fresh. **FASCIA PERIMETRALE:** Air System in tessuto reticolare alta traspirazione, sfoderabile, con maniglie e doppia cerniera perimetrale con divisibile. **IMBOTTITURA:** 100% fibra Polyfill anallergica traspirante antipolvere (sui due lati). **STRUTTURA:** 1 Strato di termo Visco Memory Foam (termosensibile Viscoelastico) H cm. 3 multizona (lato invernale) profilo ad ondine multizona. 2 Strato in alto Sp in EcoFoam (poliuretano a cellula aperta, schiumato ad acqua, densità medio/alta). 3 Strato di EcoFoam Ultrasoft H cm. 2,5 (lato estivo) profilo ad ondine multizona. **PORTANZA:** Medio/alta comfort. **SPESORE:** H cm. 21 ca: (lastra spessore cm 18,0 ca).

COVER: SilverAir: silver-treated anti-allergy fabric, can be removed and washed in water at 30°C. **FABRIC:** Stretch, Silver Fresh treatment. **EDGE BAND:** Air System in highly breathable mesh fabric, removable, with handles and twin edge zip fasteners for separation. **UPHOLSTERY:** 100% breathable, dust-proof anti-allergy Polyfill fibre (on both sides). **STRUCTURE:** 1 Layer of temperature-sensitive Visco-Elastic Memory Foam Ht 3 cm, multizone (winter side), multizone wave profile. 2 Thick layer of EcoFoam (medium/high density water-foamed open-cell polyurethane). 3 Layer of Ultrasoft EcoFoam Ht 2.5 cm (summer side) with multizone wave profile. **RIGIDITY:** Medium/high comfort. **THICKNESS:** Ht 21 cm approx. (main body 18.0 cm approx.).



H Ht	21	P Dpt	190		
L W	Kg	COD.			
80	10	VF33.42Q			
90	11,3	VF33.74U			
120	15	VF33.79B			
160	20	VF34.07E			

H Ht	21	P Dpt	200		
L W	Kg	COD.			
80	-	-			
90	11,8	VF33.47X			
120	15,8	VF33.52V			
160	21,1	VF34.08M			



ALICUDI

1600 MOLLE INSACCHETTATE MICROPOCKET 1600 MICRO-POCKET SPRINGS

1 TESSUTO: Elasticizzato con trattamento anallergico. Fisso. **2 IMBOTTITURA:** Lato invernale: Strato di 100% pura fibra PolyFill Termal (lana selezionata + fibra poliestere anallergica) + strato di poliuretano. Lato estivo: strato di 100% pura fibra PolyFill Fresh (cotone selezionato + fibra poliestere anallergica) + strato di poliuretano. **3 STRUTTURA:** Micro-molle insacchettate (densità circa 1600 molle, nella versione matrimoniale) a movimento indipendente con strato di poliuretano alto spessore con profilo ad ondine sui due lati. **PORTANZA:** Medio-alta. **SPESORE:** H cm. 23 ca.

1 FABRIC: Stretch with anti-allergy treatment. Fixed. **2 UPHOLSTERY:** Winter side: Layer of 100% pure PolyFill Thermal fibre (high grade wool + anti-allergy polyester fibre) + layer of polyurethane. Summer side: layer of 100% pure PolyFill Fresh fibre (high grade cotton + anti-allergy polyester fibre) + layer of polyurethane. **3 STRUCTURE:** Micro-pocket springs (density about 1600 springs in double bed version) with independent movement, with thick layer of wave-profile polyurethane on both sides. **RIGIDITY:** Medium-firm. **THICKNESS:** Ht 23 cm approx.



H Ht	23	P Dpt	190		
L W	Kg	COD.			
80	14,8	VF33.43W			
90	16,6	VF33.75A			
120	22,1	VF33.80Y			
160	29,5	VF34.09T			

H Ht	23	P Dpt	200		
L W	Kg	COD.			
80	-	-			
90	17,5	VF33.48D			
120	23,3	VF33.53B			
160	31,1	VF34.10Q			

- Anallergico
Non-allergenic
- Antistatico
Antistatic
- Ecologico e riciclabile
Ecological and recyclable

- Bonnell system
Bonnell system
- Micro-pocket 1600
Micro-pocket 1600
- Sfoderabile e lavabile in acqua
Removable and washable in water

- Schiumato ad acqua
Water foam
- Non pieghevole
Not folding
- Pieghevole
Folding

- Totale ergonomia
Complete ergonomics
- Doppia portanza
Double support
- Termo memory foam
Termo memory foam

- Ignifugo in Classe 11M (Omologato dal Ministero degli Interni) con graffiatura a punto metallico degli strati interni
Fireproof Class 11M (approved by the Ministry of the Interior) with metal point seams on the inner layers



SALINA

MATERASSO POCKET MEMORY MATTRESS POCKET MEMORY

TESSUTO: Elasticizzato con trattamento anallergico Aloe Vera. Fisso. **IMBOTTITURA:** Lato invernale/estivo: doppio strato di 100% pura fibra PolyFill anallergica ad alta traspirazione. **STRUTTURA:** 1 Molle insacchettate a zone differenziate (circa 800/1000 molle nella versione matrimoniale) a movimento indipendente. 2 Strato di Thermo Visco Memory H 3 cm (su un lato) con profilo ad ondate multizona e strato di EcoFoam H 2,5 cm ca con profilo multizona (su un lato). **PORTANZA:** Media-alta. **SPESORE:** H 23 cm ca.

FABRIC: Elasticised with Aloe Vera non-allergenic treatment. Fixed. **PADDING:** Winter/summer side: double layer in 100% pure PolyFill hypoallergenic with high transpiration fibre. **STRUCTURE:** 1 Independently moving nested springs in different zones (800/1000 springs approximately for the double version). 2 Thermo-Visco Memory layer 3 cm (on one side) with multi-zone wave profile and EcoFoam layer Ht 2.5 cm approx with multi-zone profile (on one side). **SUPPORT:** Medium-high. **THICKNESS:** Ht 23 cm approx.



H Ht	23	P Dpt	190	H Ht	23	P Dpt	200
L W	Kg	COD.		L W	Kg	COD.	
160	35	VF34.11W		160	36,8	VF34.12C	

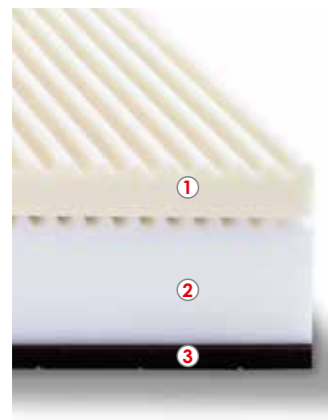

PALMAROLA

MATERASSO HIGH COMFORT MEMORY MATTRESS HIGH COMFORT MEMORY

TESSUTO: Elasticizzato con trattamento anallergico Aloe Vera. Cover sfoderabile e lavabile in acqua 30° C. **IMBOTTITURA:** Lato invernale/estivo: doppio strato di 100% pura fibra PolyFill anallergica ad alta traspirazione. **STRUTTURA:** 1 Strato di Thermo Visco Memory (termosensibile - viscoelastico) H 5 cm multizona (lato invernale); 2 Strato centrale in EcoFoam (poliuretano a cellula aperta, schiumato ad acqua) ad alta portanza, con profilo ad ondate; 3 Strato di EcoFoam Alta elasticità H 2 cm (lato estivo). **PORTANZA:** Differenziata sui due lati. **SPESORE:** H 22 cm ca (lastra spessore 19 cm ca).

FABRIC: Elastic with non-allergenic Aloe Vera treatment. The cover is removable and washable in water 30° C. **PADDING:** Winter/Summer side: double layer in 100% pure PolyFill hypoallergenic with high transpiration fibre. **STRUCTURE:** 1 Thermo-Visco Memory layer (thermo-sensitive - viscoelastic) Ht 5 cm multi-zone (winter side). 2 EcoFoam middle layer (open-cell polyurethane, water-foamed) with high carrying capacity and wave profile. 3 High elasticity EcoFoam layer Ht 2 cm. (summer side). **SUPPORT:** Different on the 2 sides. **THICKNESS:** Ht 22 cm approx. (plate height 19 cm approx.).



H Ht	22	P Dpt	190	H Ht	22	P Dpt	200
L W	Kg	COD.		L W	Kg	COD.	
160	20	VF34.13K		160	21,1	VF34.14R	



PONZA

TESSUTO: Fisso puro cotone 100%. **STRUTTURA:** Anima in fibra anallergica, antipolvere. **LAVABILITÀ:** Interamente lavabile in acqua a 30°C. **DIMENSIONI IN CM:** 80 x 50 x 10 ca.

FABRIC: Fixed, 100% pure cotton. **STRUCTURE:** Anti-allergy, dust-proof fibre core. **WASHABILITY:** Completely washable in water at 30°C. **DIMENSIONS IN CM:** 80 x 50 x 10 approx.

Guanciale in fibra anallergica. Ideale per chi gradisce un cuscino di buona consistenza e di media altezza, per tutti. L'imbottitura in fibra anallergica a struttura cava a 3 vie permette la massima circolazione d'aria, senza infeltrire e rimanendo morbida e confortevole nel tempo.

Anti-allergy fibre pillow. Ideal for those who prefer a medium-high, firm pillow, suitable for all. The anti-allergy three-way hollow fibre filling allows excellent air circulation without felting, and stays soft and comfortable over time.



COD.	
VF34.15X	

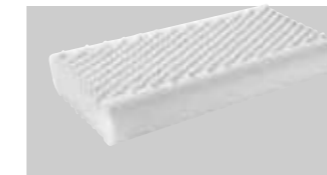

PROCIDA

TESSUTO: Elasticizzato traspirante, anallergico. Fisso. **STRUTTURA:** Anima in EcoFoam UltraSoft a saponetta con inserto massaggiante in Thermo-Visco Memory Touch nella zona accoglimento nuca. **DIMENSIONI IN CM:** 68 x 38 x 10/11 ca.

FABRIC: Stretch, breathable, anti-allergy. Fixed. **STRUCTURE:** UltraSoft EcoFoam block core with Memory Touch Visco-Elastic massaging insert in the neck area. **DIMENSIONS IN CM:** 68 x 38 x 10/11 approx.

Guanciale anallergico in EcoFoam UltraSoft, a saponetta con inserto massaggiante in Thermo-Visco Memory Touch nella zona di accoglienza nuca (sui due lati).

Anti-allergy pillow in UltraSoft EcoFoam core with Memory Touch Visco-Elastic massaging insert in the neck area (on both sides).



COD.	
VF34.16D	



MALVA

TESSUTO: Elasticizzato traspirante, anallergico. Fisso. **STRUTTURA:** Anima in lattice microforato con forma a saponetta. **DIMENSIONI IN CM:** 72 x 42 x 10 ca.

FABRIC: Stretch, breathable, anti-allergy. Fixed. **STRUCTURE:** Micro-perforated latex block core. **DIMENSIONS IN CM:** 72 x 42 x 10 approx.

Guanciale anallergico in lattice microforato. Il guanciale in lattice è molto confortevole ed antibatterico.

Micro-perforated latex anti-allergy pillow. Latex pillows are very comfortable and bacteria-resistant.



COD.	
VF34.17L	

Tutti i Comò e Settimini sono dotati di ferramenta per fissaggio a muro antiribaltamento.
All the Dressers and Tallboys are equipped with anti-overturning wall fixing hardware.

FUSION

Apertura cassetti con pomelli e maniglie di serie o push-pull.
Drawers opening with standard knob and handle or push-pull.

Piede ALFA non disponibile.
ALFA foot not available.

Cassetti con guide metalliche tipo "Quadro" rallentate (no con push-pull) di serie.
Drawers with slowed "Quadro" type metal runners as standard.

Comodino Bedside table

L W 45
P Dpt 45,8
H Ht 37,7



COD. VF06.70W



Comò Dresser

L W 120
P Dpt 57,1
H Ht 77,7

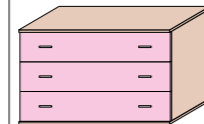

COD. VF06.71C

Settimino Tallboy

L W 45
P Dpt 45,8
H Ht 101,7



COD. VF06.72K

LUKE

Apertura cassetti con maniglia gola, disponibile nei colori:
Drawers opening with groove is available in colors:



Cassetti con chiusura rallentata di serie.
Drawers with soft closing as standard.

Comodino Bedside table

L W 48,7
P Dpt 45
H Ht 39,1

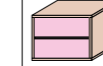

COD. VF06.20U



Comò Dresser

L W 110,1
P Dpt 57,1
H Ht 78,4

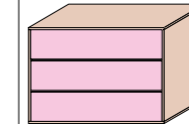

COD. VF06.21A

LINK

Apertura cassetto con presa laterale disponibile nei colori:
Drawer opening with lateral grip available in colors:



Cassetti con guide metalliche tipo "Quadro" rallentate di serie.
Drawers with slowed "Quadro" type metal runners as standard.

Comodino Bedside table

L W 45
P Dpt 47,3
H Ht 34,5



COD. VF06.00H



Comò Dresser

L W 120
P Dpt 58,6
H Ht 74,5

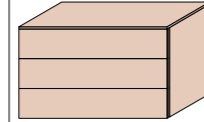

COD. VF06.01Q

Settimino Tallboy

L W 45
P Dpt 47,3
H Ht 82,5

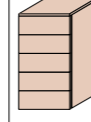

COD. VF06.02W

MASTER

Apertura cassetti con pomelli e maniglie di serie (no push-pull).
(maniglia BLADE non disponibile)
Drawers opening with standard knob and handle (no push-pull).
(BLADE handle not available)

Comodini Bedside tables

L W 45
P Dpt 45
H Ht 34,5

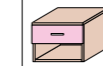

COD. VF06.30Z



COD. VF06.31F

Comò Dresser

L W 105
P Dpt 57,1
H Ht 70,6

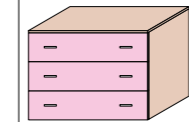

COD. VF06.32N

Settimino Tallboy

L W 45
P Dpt 45
H Ht 82,5



COD. VF06.33U

LINK PLUS

Apertura cassetto con presa laterale disponibile nei colori:
Drawer opening with lateral grip available in colors:



Solo con pattini salvamobile H 0,7.
Only with runners Ht 0,7.

Cassetti con guide metalliche tipo "Quadro" rallentate di serie.
Drawers with slowed "Quadro" type metal runners as standard.

Comodini Bedside tables

L W 66,4 Mensola L 21 P 43,2
P Dpt 49,8 Shelf W 21 Dpt 43,2
H Ht 50,9

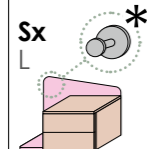

COD. VF06.10P

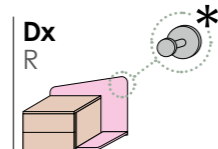

COD. VF06.11V

Comò Dresser

L W 146,4 Mensola L 26 P 54,5
P Dpt 61,1 Shelves W 26 Dpt 54,5
H Ht 90,8

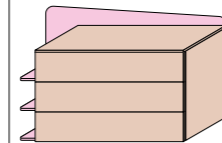

COD. VF06.12B

Settimino Tallboy

L W 71,4 Mensola L 26 P 43,2
P Dpt 49,8 Shelves W 26 Dpt 43,2
H Ht 98,8

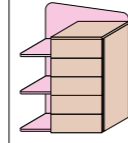

COD. VF06.13H

OVER

Cassetti con apertura push-pull e inserto in MDF Sp 0,4 applicato sul primo cassetto disponibile nei colori:
Drawers with push-pull opening and mdf Th 0.4 insert applied to the first drawer and available in the colors:



Cassetti con guide metalliche tipo "Quadro" rallentate di serie.
Drawers with slowed "Quadro" type metal runners as standard.

Comodino Bedside table

L W 45
P Dpt 46
H Ht 34,5

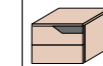

COD. VF06.40E



Comò Dresser

L W 120
P Dpt 57,3
H Ht 74,5

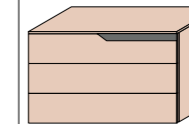

COD. VF06.41M

Settimino Tallboy

L W 45
P Dpt 46
H Ht 82,5

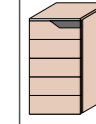

COD. VF06.42T

Accessori Accessories

I Gruppi sono dotati di pattini salvamobile H 0,7.
A discrezione, se non diversamente indicato è possibile applicare i Piedini regolabili.
The Groups are equipped with H 0,7 "save furniture" feet.
At discretion, the Adjustable feet can be applied unless otherwise indicated.

Piedini regolabili - Confezione 4 pezzi Adjustable feet - Pack of 4 pieces

ALFA 25
L W 2,5

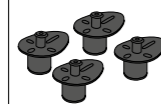

COD. VF32.32E

ETA
L W 10
H Ht 4

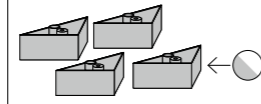

COD. VF32.33M

SIGMA
L W 8,3
H Ht 11

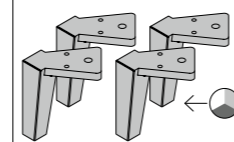

COD. VF32.34T

BOLLINO appendiabiti clothes hook

Ø 10
P Dpt 4

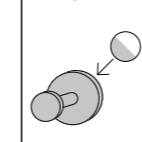

COD. VF32.61Q

* Opzionale per comodini LINK PLUS e OVER PLUS
Optional for LINK PLUS and OVER PLUS bedside tables

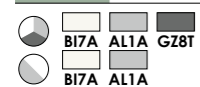

Tutti i Comò e Settimini sono dotati di ferramenta per fissaggio a muro antiribaltamento.
All the Dressers and Tallboys are equipped with anti-overturning wall fixing hardware.

OVER PLUS

Cassetti con apertura push-pull e inserto in mdf Sp 0.4 applicato sul primo cassetto disponibile nei colori:



Drawers with push-pull opening and mdf Th 0.4 insert applied to the first drawer and available in the colors:

Solo con pattini salvamobile H 0.7.
With runners HT 0.7 only.

Cassetti con guide metalliche tipo "Quadro" rallentate di serie.
Drawers with slowed "Quadro" type metal runners as standard.

Comodini Bedside tables

L W 66,4 Mensola L 21 P 43,2
P Dpt 48,5 Shelf W 21 Dpt 43,2
H Ht 50,9

Sx

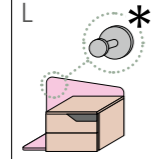

Dx

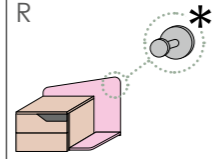

Comò Dresser

L W 146,4 Mensola L 26 P 54,5
P Dpt 59,8 Shelves W 26 Dpt 54,5
H Ht 90,8

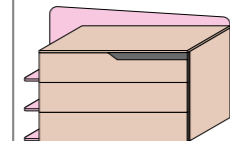

Settimino Tallboy

L W 71,4 Mensola L 26 P 43,2
P Dpt 48,5 Shelves W 26 Dpt 43,2
H Ht 98,8

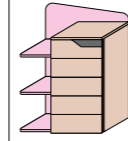

COD.	VF06.50L	VF06.51S	VF06.52Y	VF06.53E
	A			
	B			

TRAY

Apertura cassetti con pomelli e maniglie di serie (no push-pull).
Drawers opening with standard knob and handle (no push-pull).

Comodino Bedside table

L W 48,6
P Dpt 47,4
H Ht 39,5



Comò Dresser

L W 123,6
P Dpt 58,4
H Ht 79,5

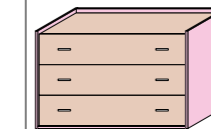

Settimino Tallboy

L W 63,6
P Dpt 47,4
H Ht 103,5

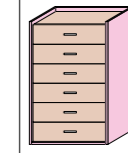

COD.	VF06.60R	VF06.61X	VF06.62D
	A		
	B		

SPLIT

Cassetti con apertura push-pull e inserto in mdf Sp 0.4.
Drawers with push-pull opening and mdf Th 0.4 insert.

Cassetti con guide metalliche tipo "Quadro" rallentate di serie.
Drawers with slowed "Quadro" type metal runners as standard.

Comodini Bedside tables

L W 45
P Dpt 46
H Ht 34,5

Sx

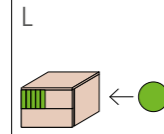

Dx

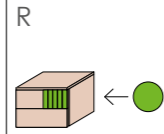

Comò Dresser

L W 120
P Dpt 57,3
H Ht 74,5

Con 1 inserto
With 1 insert

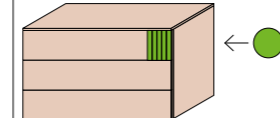

Con 2 inserti
with 2 inserts

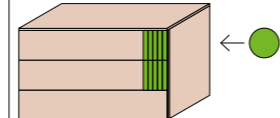

COD.	VF06.43Z	VF06.44F	VF06.45N	VF06.46U
	A			
	B			

SPLIT

Cassetti con apertura push-pull e inserto in mdf Sp 0.4.
Drawers with push-pull opening and mdf Th 0.4 insert.

Cassetti con guide metalliche tipo "Quadro" rallentate di serie.
Drawers with slowed "Quadro" type metal runners as standard.

Settimino Tallboy

L W 45
P Dpt 46
H Ht 82,5

Con 1 inserto
With 1 insert

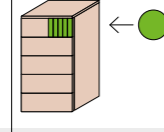

Con 2 inserti
with 2 inserts

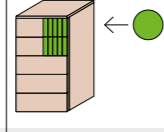

COD.	VF06.47A	VF06.48G
	A	
	B	

BOLLINO appendiabiti clothes hook

Ø 10
P Dpt 4

* Opzionale per comodini LINK PLUS e OVER PLUS
Optional for LINK PLUS and OVER PLUS bedside tables

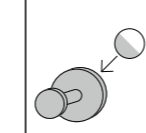

COD.	VF32.61Q
------	----------

Accessori Accessories

I Gruppi sono dotati di pattini salvamobile H 0.7.
A discrezione, se non diversamente indicato è possibile applicare i Piedini regolabili.
The Groups are equipped with H 0.7 "save furniture" feet.
At discretion, the Adjustable feet can be applied unless otherwise indicated.

Piedini regolabili - Confezione 4 pezzi Adjustable feet - Pack of 4 pieces

ALFA 25

L W 2,5



ETA

L W 10
H Ht 4

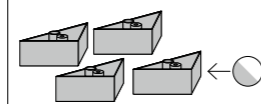

SIGMA

L W 8,3
H Ht 11

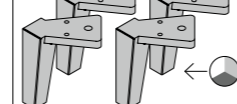

COD.	VF32.32E	VF32.33M	VF32.34T
------	----------	----------	----------



Specchiere Mirrors

• Posizionabili sia verticali che orizzontali

• Positioned both vertical and horizontal

Con cornice

With frame

PINTA 1

L W 80
H Ht 80
Sp Th 2,5

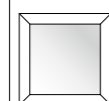

Colori disponibili:
Available colours:
CB6K BI7A GL4R

PINTA 2

L W 80
H Ht 190
Sp Th 2,5

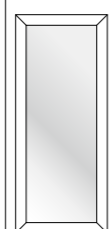

Colori disponibili:
Available colours:
CB6K BI7A GL4R

PINTA 3

L W 60
H Ht 112
Sp Th 2,5



Colori disponibili:
Available colours:
CB6K BI7A GL4R

COD.	VF06.80B	VF06.81H	VF06.82Q
------	----------	----------	----------

Con specchio Sp 0,4 applicato su pannello in nobilitato Sp 1,8

With mirror Th 0.4 on melamine panel Th 1.8

QUADRO 1

L W 95,6
H Ht 68,7
Sp Th 2,2

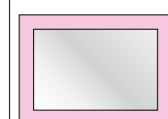

QUADRO 2

L W 95,6
H Ht 68,7
Sp Th 2,2



QUADRO 3

L W 95,6
H Ht 68,7
Sp Th 2,2



QUADRO 4

L W 95,6
H Ht 68,7
Sp Th 2,2

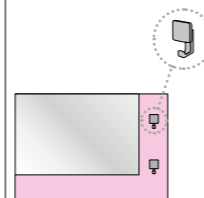

COD.	VF06.83W	VF06.84C	VF06.85K	VF06.86R
	(A)			
	(B)			

Con specchio Sp 0,4 applicato su pannello in nobilitato

With mirror Th 0.4 on melamine panel

WINNER

L W 104
H Ht 79
Sp Th 2,2

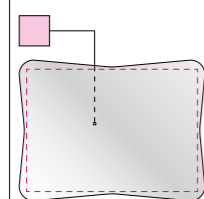

SASSO

Specchio irregolare
Irregular mirror

L W 110,3
H Ht 75,2
Sp Th 1,8

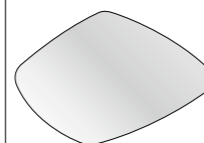

STONES

Set 3 specchi irregolari
Set of 3 irregular mirrors

L W 52,7	L W 55,1	L W 30
H Ht 57,5	H Ht 37,6	H Ht 54
Sp Th 1,8	Sp Th 1,8	Sp Th 1,8

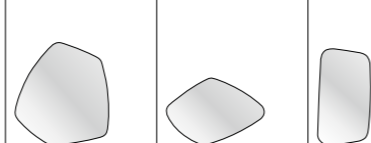

COD.	VF06.87X	JC50.58K	JC50.57C
	(A)		
	(B)		

Accessori Accessories

PLUS appendiabiti clothes hook

L W 4,3
P Dpt 3
H Ht 6,5



COD. VF32.62W



ALTA

Facciate Fronts
VOLO

Finiture GRUPPO 1
GROUP 1 finishes

Finiture GRUPPO 2
GROUP 2 finishes

Rovere white*

(A) ☆ Rovere white RW3Q	(A) ☆ Rovere gesso RG9L	(A) ☆ Ciliegio bianco CB6K	(A) Grigio Dorian GL4R	(B) ☆ Cemento artico CA7A	(B) ☆ Rovere cognac RC3Q
(B) ☆ Royal oak RS4B	(B) Grigio titanio GZ8T	(B) Oliva LV5T	(B) Cadaques CQ3Q		
(A) Bianco opaco B17A	(B) Giallo zafferano GZ8A	(B) Albicocca AB3C	(B) Orchidea OR7L	(B) Blu Egeo EG4L	

Vetri Glass

Ante Doors
WINDOW

Colori telaio
Frame colours

Trasparente TR9M	Trasparente fumé FT8P	Stop sol ST6P	Specchio SP7L	Alluminio AL1A	Titan grey TG7H
----------------------------	---------------------------------	-------------------------	-------------------------	--------------------------	---------------------------

Rovere white* Finitura unica per tutti i componenti in pannello presenti a listino non evidenziati con il colore Finiture GRUPPO 1 e/o Finiture GRUPPO 2.
Unique finish for all the panel components shown in the pricelist not highlighted with the color finishes GROUP 1 and/or finishes GROUP 2.

- A** Finiture in fascia di prezzo A
Finishes in price range A
- B** Finiture in fascia di prezzo B
Finishes in price range B
- ☆ Finiture con effetto materico
Finishes with textured effect

SCRIVANIE, MENSOLE E CUBOLOTTI
DESKS, SHELVES AND CUBES

Scrivanie BANNER - H 77,6 P 57,1 BANNER desks - Ht 77.6 Dpt 57.1	pag. 154
Scrivanie WINNER - H 77,6 P 63,5 WINNER desks - Ht 77.6 Dpt 63.5	pag. 156
Scrivanie SWITCH - H 77,6 P 63,3 SWITCH desks - Ht 77.6 Dpt 63.3	pag. 158
Scrivanie ICS - H 77,6 P 57,1 ICS desks - Ht 77.6 Dpt 57.1	pag. 160
Scrivanie ALPA - H 77,6 ALPA desks - Ht 77.6	pag. 161
Scrivanie CORNER - H 77,6 P 90 CORNER desks - Ht 77.6 Dpt 90	pag. 162
Accessori per scrivanie Desks accessories	pag. 163
Mensole - Sp 2,5 P 26 Shelves - Th 2.5 Dpt 26	pag. 164
Cubolotti Cubes	pag. 166
PlayWood® PlayWood®	pag. 168
Composizioni con PlayWood® - P 44,7 Compositions with PlayWood® - Dpt 44.7	pag. 169
Pannelli attrezzati STRIP - P 20 STRIP equipped panels - Dpt 20	pag. 170
Pannelli attrezzati BING - P 28,5 BING equipped panels - Dpt 28.5	pag. 170
Pannelli attrezzati DROP - P 20,5 DROP equipped panels - Dpt 20.5	pag. 170
Pannelli attrezzati EXPILON - P 28,5 EXPILON equipped panels - Dpt 28.5	pag. 171
Pannelli attrezzati STRANGE - H 90 STRANGE equipped panels - Ht 90	pag. 172
Pannelli attrezzati porta TV - H 90 Equipped panels for TV - Ht 90	pag. 173

Scrivanie BANNER - H 77,6 P 57,1

BANNER desks - Ht 77.6 Dpt 57.1

Piano BANNER Sp 2,5 bordato in ABS
Fianchi in pannello Sp 1,8

BANNER top Th 2.5 with ABS edging
Side panels Th 1.8

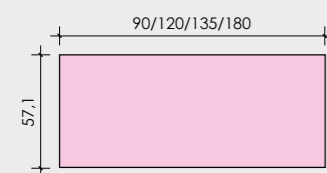

- In presenza di due gambe ONE o THREE si consiglia di fissare la scrivania al muro con la ferramenta in dotazione.
- In the presence of two legs "ONE" or "THREE" it is advisable to fix the desk to the wall with the hardware supplied.

Nel momento in cui si ordina una scrivania L120-135-180 è possibile dotarla di accessori integrati per i quali è necessaria l'esecuzione di fori sui piani (foratura a nostra cura). Possono essere scelti uno o più accessori:

When ordering a desk W120-135-180, it can be fitted with built-in accessories requiring holes to be drilled in the tops (drilled by us). One or more accessories can be chosen:



Ricarica wireless + presa USB
Wireless charging + USB socket



Copriforo per passacavi
Cover for wire leads

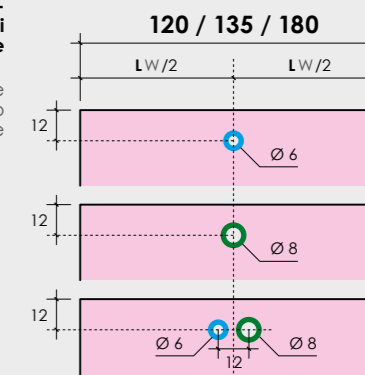

L
W **90**

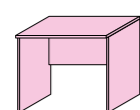

COD. VF15.00G

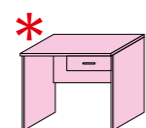

COD. VF15.01P

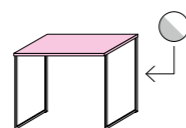

COD. VF15.02V

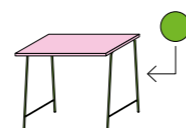

COD. VF15.03B

A
B

L
W **120**

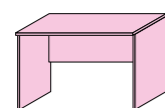

COD. VF15.04H

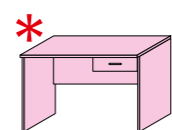

COD. VF15.05Q

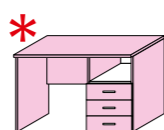

COD. VF15.06W

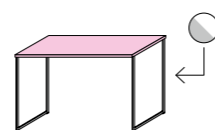

COD. VF15.07C

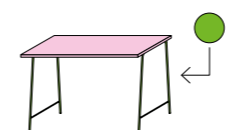

COD. VF15.08K

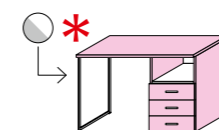

COD. VF15.09R

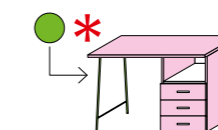

COD. VF15.10N

A
B

L
W **135**

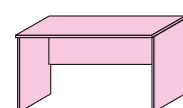

COD. VF15.11U

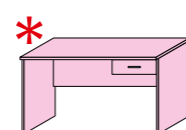

COD. VF15.12A

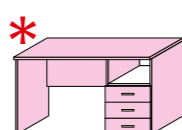

COD. VF15.13G

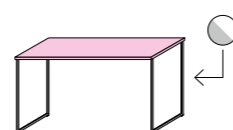

COD. VF15.14P

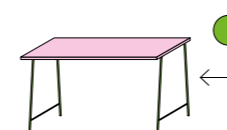

COD. VF15.15V

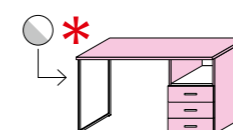

COD. VF15.16B

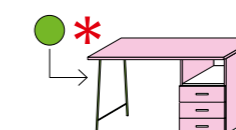

COD. VF15.17H

A
B

L
W **180**

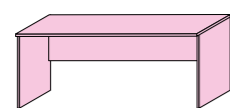

COD. VF15.18Q

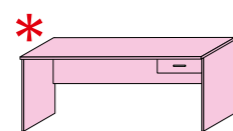

COD. VF15.19W

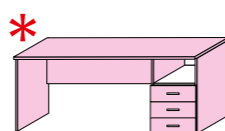

COD. VF15.20T

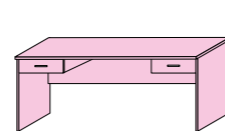

COD. VF15.21Z

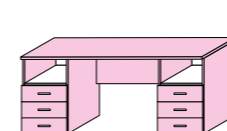

COD. VF15.22F

A
B

L su misura
Custom W

min 45 - max 220

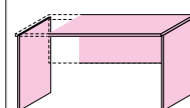

COD. VF15.23N

min 91 - max 220

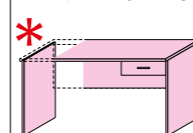

COD. VF15.24U

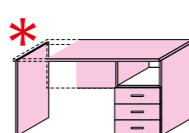

COD. VF15.25A

A
B

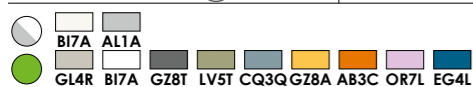

* Specificare Sx o Dx (disegno Dx)
Specify L or R (R drawing)

pag. 40
pag. 163

Posizionamento pomelli e maniglie
Knobs and handles position
Accessori per scrivanie
Desks accessories

Scrivanie WINNER - H 77,6 P 63,5

WINNER desks - Ht 77.6 Dpt 63.5

**Piano WINNER Sp 2,5 bordato in ABS
Fianchi in pannello Sp 1,8**

WINNER top Th 2.5 with ABS edging
Side panels Th 1.8

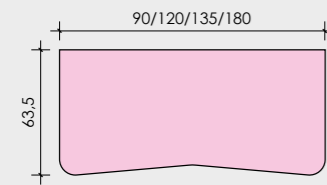

- In presenza di due gambe ONE o THREE si consiglia di fissare la scrivania al muro con la ferramenta in dotazione.
- In the presence of two legs "ONE" or "THREE" it is advisable to fix the desk to the wall with the hardware supplied.

Nel momento in cui si ordina una scrivania è possibile dotarla di accessori integrati per i quali è necessaria l'esecuzione di fori sui piani (foratura a nostra cura).
Possono essere scelti uno o più accessori:

When ordering a desk, it can be fitted with built-in accessories requiring holes to be drilled in the tops (drilled by us).
One or more accessories can be chosen:



Ricarica wireless + presa USB
Wireless charging + USB socket



Copriforo per passacavi
Cover for wire leads

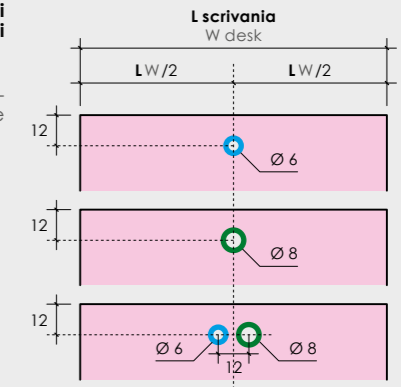

**L
W 90**

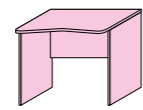

COD. VF15.30Y

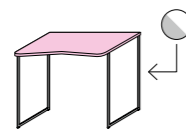

COD. VF15.31E

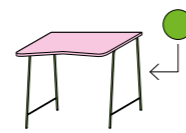

COD. VF15.32M

A
B

**L
W 120**

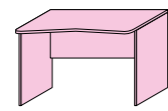

COD. VF15.33T

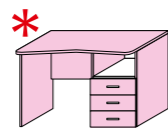

COD. VF15.34Z

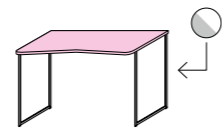

COD. VF15.35F



COD. VF15.36N

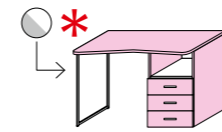

COD. VF15.37U

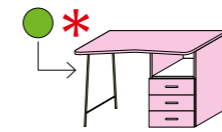

COD. VF15.38A

A
B

**L
W 135**

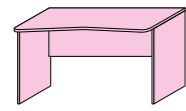

COD. VF15.39G

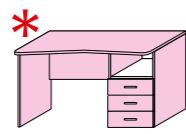

COD. VF15.40D

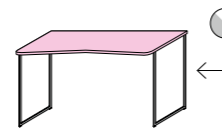

COD. VF15.41L

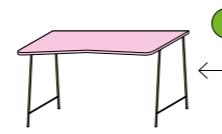

COD. VF15.42S

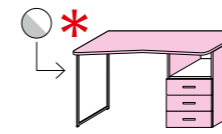

COD. VF15.43Y

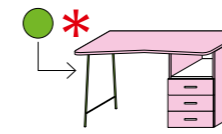

COD. VF15.44E

A
B

**L
W 180**

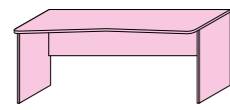

COD. VF15.45M

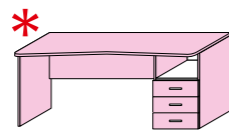

COD. VF15.46T

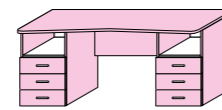

COD. VF15.47Z

A
B

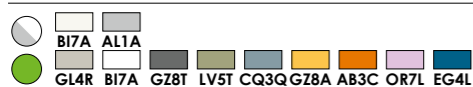

* Specificare Sx o Dx (disegno Dx)
Specify L or R (R drawing)

pag. 40
pag. 163

Posizionamento pomelli e maniglie
Knobs and handles position
Accessori per scrivanie
Desks accessories

Scrivanie SWITCH - H 77,6 P 63,3

SWITCH desks - Ht 77.6 Dpt 63.3

Piano SWITCH Sp 2,5 bordato in ABS Fianchi sagomati in pannello Sp 2,5

SWITCH top Th 2.5 with ABS edging
Shaped side panels Th 2.5

- In presenza di due gambe ONE o THREE si consiglia di fissare la scrivania al muro con la ferramenta in dotazione.
- In the presence of two legs "ONE" or "THREE" it is advisable to fix the desk to the wall with the hardware supplied.

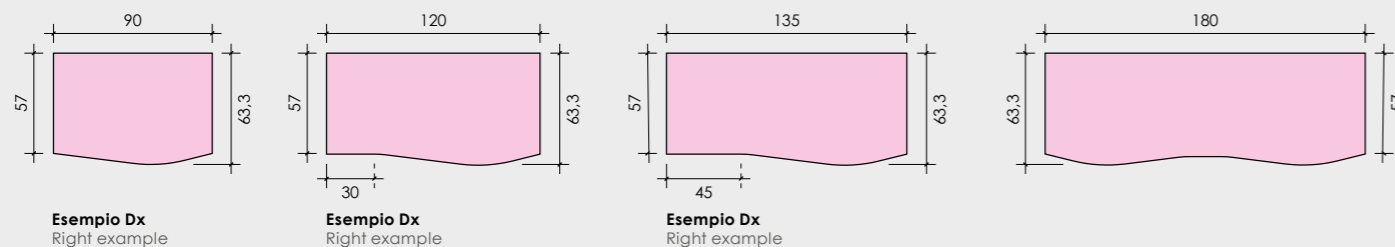

Nel momento in cui si ordina una scrivania è possibile dotarla di accessori integrati per i quali è necessaria l'esecuzione di fori sui piani (foratura a nostra cura).
Possono essere scelti uno o più accessori:
When ordering a desk, it can be fitted with built-in accessories requiring holes to be drilled in the tops (drilled by us).
One or more accessories can be chosen:



• **Ricarica wireless + presa USB**
Wireless charging + USB socket



• **Copriforo per passacavi**
Cover for wire leads

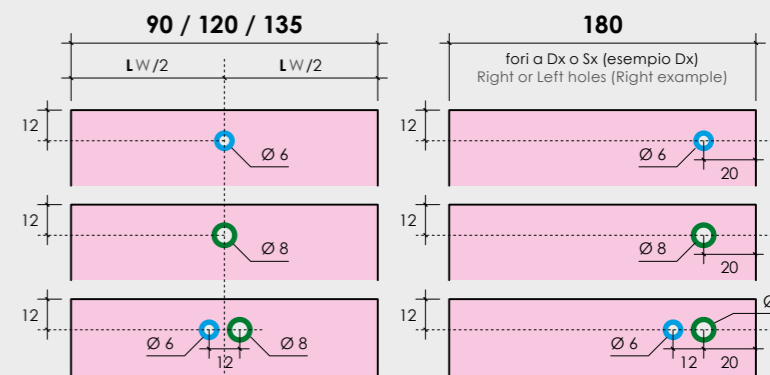

L 90

Specificare Sx o Dx (disegno Dx)
Specify L or R (R drawing)

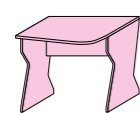

VF15.50K

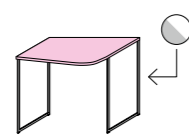

VF15.51R

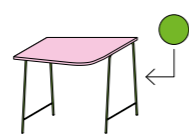

VF15.52X

COD.

A
B

L 120

Specificare Sx o Dx (disegno Dx)
Specify L or R (R drawing)

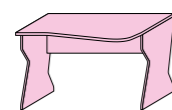

VF15.53D

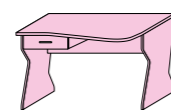

VF15.54L

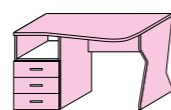

VF15.55S

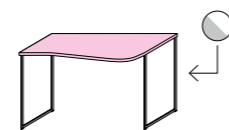

VF15.56Y

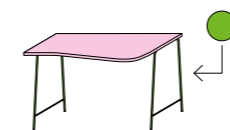

VF15.57E

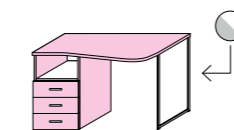

VF15.58M

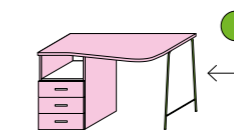

VF15.59T

COD.

A
B

L 135

Specificare Sx o Dx (disegno Dx)
Specify L or R (R drawing)

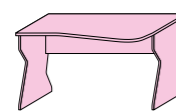

VF15.60Q

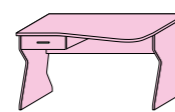

VF15.61W

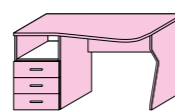

VF15.62C

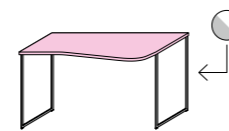

VF15.63K

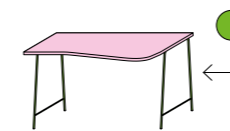

VF15.64R

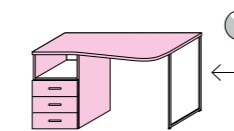

VF15.65X

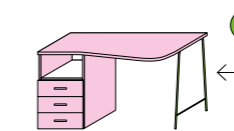

VF15.66D

COD.

A
B

L 180

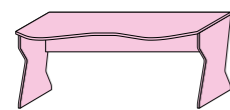

VF15.67L

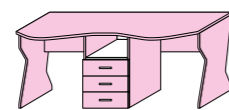

VF15.68S

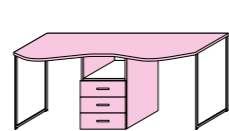

VF15.69Y

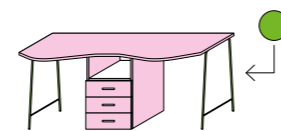

VF15.70V

COD.

A
B



pag. 40
pag. 163

Posizionamento pomelli e maniglie
Knobs and handles position
Accessori per scrivanie
Desks accessories

Scrivanie ICS - H 77,6 P 57,1

ICS desks - Ht 77.6 Dpt 57.1

Piano ICS Sp 2,5 bordato in ABS
Fianchi sagomati in pannello Sp 2,5
ICS top Th 2.5 with ABS edging
Shaped side panels Th 2.5

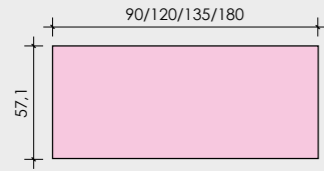

Nel momento in cui si ordina una scrivania è possibile dotarla di accessori integrati per i quali è necessaria l'esecuzione di fori sui piani (foratura a nostra cura).

Possono essere scelti uno o più accessori:
When ordering a desk, it can be fitted with built-in accessories requiring holes to be drilled in the tops (drilled by us).
One or more accessories can be chosen:



Ricarica wireless + presa USB
Wireless charging + USB socket



Copriforo per passacavi
Cover for wire leads

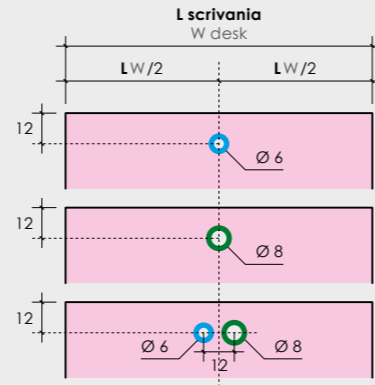

Scrivanie ALPA - H 77,6

ALPA desks - Ht 77.6

Piano ALPA Sp 2,5 bordato in ABS
Fianchi in pannello Sp 1,8
ALPA top Th 2.5 with ABS edging
Side panels Th 1.8

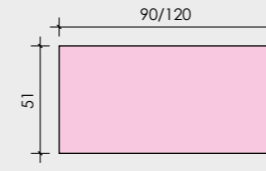

Nel momento in cui si ordina una scrivania è possibile dotarla di accessori integrati per i quali è necessaria l'esecuzione di fori sui piani (foratura a nostra cura).

Possono essere scelti uno o più accessori:
When ordering a desk, it can be fitted with built-in accessories requiring holes to be drilled in the tops (drilled by us).
One or more accessories can be chosen:



Ricarica wireless + presa USB
Wireless charging + USB socket



Copriforo per passacavi
Cover for wire leads

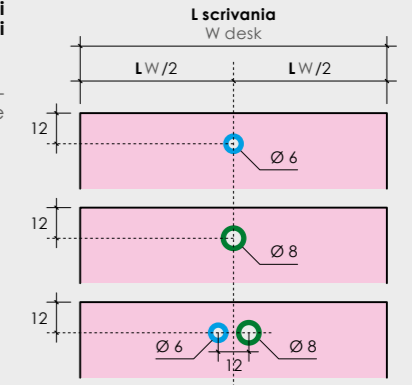

- Pannello retro sagomato Sp 2,5 bordato in ABS.
- Complete di kit di fissaggio a muro o a pannello.
- Shaped back panel Th 2.5 with ABS edging.
- Including wall or panel-fixing kit.

L W 90

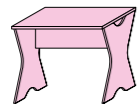

COD. VF15.80A

A
B

L W 120

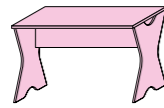

COD. VF15.81G VF15.82P

A
B

L W 135

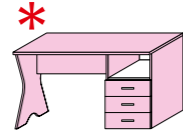
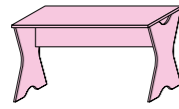

COD. VF15.83V VF15.84B

A
B

L W 180

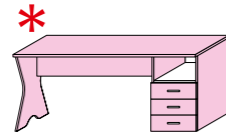
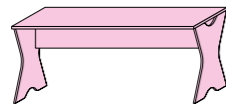

COD. VF15.85H VF15.86Q

A
B

* Specificare Sx o Dx (disegno Dx)
Specify L or R (R drawing)

	Con cassetto With drawer	Con 2 ripiani With 2 shelves	Senza ripiani Without shelves
Piano scrivania Desk top			
L W 90			
COD.	VF15.90F	VF15.91N	VF15.92U
	A B		
Piano scrivania Desk top			
L W 120			
COD.	VF15.93A	VF15.94G	VF15.95P
	A B		

pag. 40
pag. 163

Posizionamento pomelli e maniglie
Knobs and handles position
Accessori per scrivanie
Desks accessories

Scrivanie CORNER - H 77,6 P 90

CORNER desks - Ht 77.6 Dpt 90

Piano sagomato CORNER Sp 2,5 bordato in ABS (Sx)
CORNER shaped top Th 2.5 with ABS edging (L)

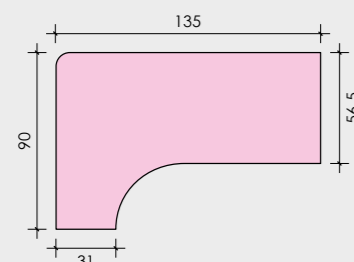

Nel momento in cui si ordina una scrivania è possibile dotarla di accessori integrati per i quali è necessaria l'esecuzione di fori sui piani (foratura a nostra cura).

Possono essere scelti uno o più accessori: When ordering a desk, it can be fitted with built-in accessories requiring holes to be drilled in the tops (drilled by us). One or more accessories can be chosen:



Ricarica wireless + presa USB
Wireless charging + USB socket



Copriforo per passacavi
Cover for wire leads

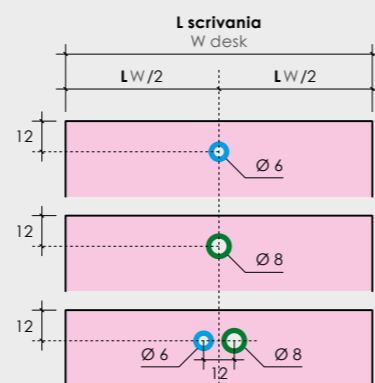

L W 135

Sx L

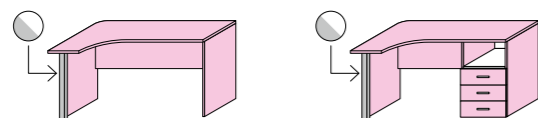

COD. VF16.00M VF16.01T

A
B

L W 135

Dx R

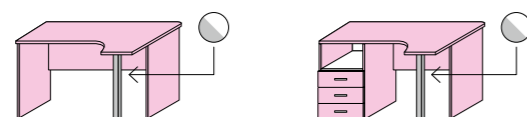

COD. VF16.02Z VF16.03F

A
B

Accessori per scrivanie

Desks accessories

Portatastiera estraibile in metallo

Pull-out metal keyboard holder

L W 59
P Dpt 29,5
H Ht 6

Per un corretto utilizzo, verificare la sagoma del piano su cui viene fissato
For a proper employment, check top shape on which it will be fixed

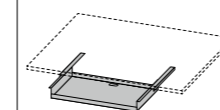

COD. VF34.45P

Porta PC con ruote

PC holder with castors

L W 29
P Dpt 50
H Ht 39

Posizionabile all'esterno o all'interno delle scrivanie
Can be placed outside or inside desks

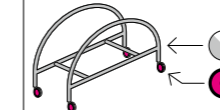

COD. VF34.46V

Porta PC sospeso regolabile

Adjustable suspended PC holder

L W 16/22
P Dpt 26,5
H Ht 58

Con attacco sottopiano
With under-top attachment

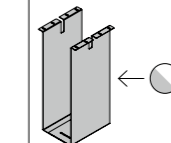

COD. VF34.47B

Barra antiriflesso

Anti-reflection bar

L W 105
P Dpt 8

Per rinforzare piani scrivania maggiori di 120 cm
To reinforce tops larger than 120 cm



COD. VF34.48H

Ricarica wireless + presa USB da incasso
Wireless charging + USB socket

∅ 6

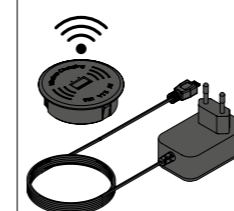

COD. VF34.49Q

Copriforo per passacavi

Cover for wire leads

∅ 8

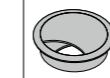

COD. VF34.50M

Gamba di sostegno ONE

ONE supporting leg
L W 2,5
P Dpt 55,5
H Ht 75,1

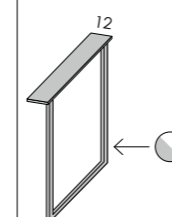

COD. VF34.51T

Gamba di sostegno THREE

THREE supporting leg
∅ 2,8
P Dpt 56,5
H Ht 75,1

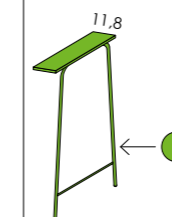

COD. VF34.52Z

Gamba di sostegno TWO

TWO supporting leg
L W 5
P Dpt 5
H Ht 75,1

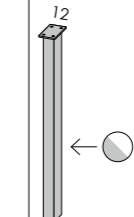

COD. VF34.53F

Cassettiere

Chest of drawers
L W 45
P Dpt 45,8
H Ht 51,2

Ruote con freno
Casters with brakes



COD. VF34.54N

A
B

L W 45
P Dpt 45,8
H Ht 51,2

Ruote senza freno
Casters without brakes



COD. VF34.55U

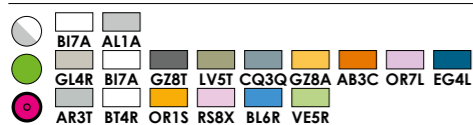

Mensole - Sp 2,5 P 26

Shelves - Th 2.5 Dpt 26

	L W 45	L W 60	L W 90	L W 118	L W 120	L W 135	L W 178
COD. Senza reggimensola Without shelf holder	VF16.10S	VF16.30C	VF16.11Y	VF16.12E	VF16.13M	VF16.18U	VF16.19A
COD. Con reggimensola With shelf holders	VF16.14T ²	VF16.31K ²	VF16.15Z ²	VF16.16F ²	VF16.17N ²	VF16.22L ²	VF16.23S ²
A scomparsa Integrated	(A) (B)						
LAMPO	(A) (B)						
KUB	(A) (B)						

	L W 180	L W 208	L W 223	L W 238	Su misura Custom-made L W min 30 - max 360	
COD. Senza reggimensola Without shelf holder	VF16.20X	VF16.21D	VF16.26M	VF16.32R	VF16.27T	
COD. Con reggimensola With shelf holders	VF16.24Y ²	VF16.25E ⁴	VF16.28Z ⁴	VF16.33X ⁴	VF16.29F ²	
A scomparsa Integrated	(A) (B)					
LAMPO	(A) (B)					
KUB	(A) (B)					

Per mensole su misura superiori a L 180 vengono forniti 2 reggimensola aggiuntivi
For custom-made shelves over W 180, 2 additional shelf holders are supplied

CARICO MASSIMO CONSIGLIATO (al netto delle mensole)

MAXIMUM RECOMMENDED LOAD (shelves weight excluded)

30 Kg per ogni coppia di reggimensola
for every pair of shelf holders

NB. Il carico si intende uniformemente distribuito sulla mensola. Tra 2 reggimensola ci deve essere una distanza non superiore a 135 cm

NOTE. Load shall be evenly distributed on the shelf. The maximum distance between 2 shelf holders shall be 135 cm

Accessori Accessories	Coppie di reggimensola Pair of shelf holders		
	A scomparsa Integrated	LAMPO L W 3,5 P Dpt 8	KUB L W 3 P Dpt 4
COD.	VF32.27G	VF32.28P	VF32.29V

Apertura: Opening:
min 1,5 max 3,5

Apertura: Opening:
min 2 max 4

2 4 Numero di reggimensola in dotazione
Number of shelf holders supplied

2 4 Provvisti di ferramenta per fissaggio a pannello.
In caso di fissaggio a muro la scelta del tipo di tassello da utilizzare dovrà essere fatta dal montatore sulla base delle caratteristiche della parete.
Complete with hardware for fixing to panel.
In case of wall fixing the choice of hardware depends on the wall conditions and should be made by the assembler.

MASK

Applicabile a muro e a pannello. Ferramenta inclusa. Posizionabili sia orizzontali che verticali. È possibile creare una composizione accostando, sovrapponendo e ruotando più elementi.

Applicable to wall and panel. Hardware included. Positionable horizontal or vertical. It is possible to create a composition by combining, superpositioning and rotating more elements.

L W 57
P Dpt 32,5
H Ht 44

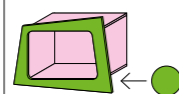

CARICO MASSIMO CONSIGLIATO
MAXIMUM RECOMMENDED LOAD
15 Kg

COD. VF16.50P

A

B

NET

Applicabili a muro e pannello. Ferramenta inclusa. È possibile creare una composizione accostando e ruotando più elementi.

Can be applied to wall or panel. Hardware included. A composition can be created by rotating and lining up several elements.

1
L W 56,5
P Dpt 30,7
H Ht 35,5

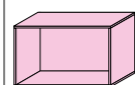

2
L W 56,5
P Dpt 30,7
H Ht 35,5

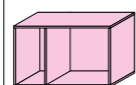

CARICO MASSIMO CONSIGLIATO
MAXIMUM RECOMMENDED LOAD
30 Kg a muro on wall **10 Kg** a pannello on panel

COD. VF16.41Q VF16.42W

A

B

ROBIN

Applicabile a muro, a pannello o in appoggio. Ferramenta inclusa. È possibile creare una composizione accostando, sovrapponendo e ruotando più elementi.

Applicable to wall, to panel or laid. Hardware included. It is possible to create a composition by combining, superpositioning and rotating more elements.

L W 34
P Dpt 30,7
H Ht 32



CARICO MASSIMO CONSIGLIATO
MAXIMUM RECOMMENDED LOAD
30 Kg a muro on wall **10 Kg** a pannello on panel

COD. VF16.40H

A

B

TIXE

Lamiera Sp 0,2, schiena in pannello Sp 1,8. Applicabili a muro. Ferramenta inclusa. È possibile creare una composizione accostando più elementi.

Sheet metal Th 0.2, back panel Th 1.8. Can be applied to wall. Hardware included. A composition can be created by lining up several elements.

1
L W 45
P Dpt 30,7
H Ht 42

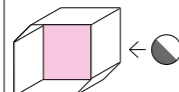

2
L W 60
P Dpt 30,7
H Ht 42

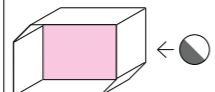

CARICO MASSIMO CONSIGLIATO
MAXIMUM RECOMMENDED LOAD
15 Kg

3
L W 90
P Dpt 30,7
H Ht 42

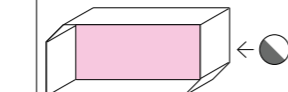

COD. VF16.47D VF16.48L VF16.49S

A

B

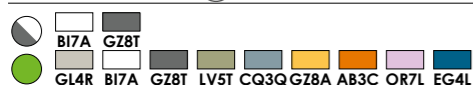

WEB

Applicabili a muro e pannello. Ferramenta inclusa. È possibile creare una composizione accostando e ruotando più elementi.

Can be applied to wall or panel. Hardware included. A composition can be created by rotating and lining up several elements.

1
L W 42
P Dpt 19,8
H Ht 42

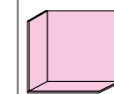

2
L W 42
P Dpt 19,8
H Ht 42

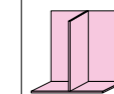

CARICO MASSIMO CONSIGLIATO
MAXIMUM RECOMMENDED LOAD
15 Kg

3
L W 84
P Dpt 19,8
H Ht 42

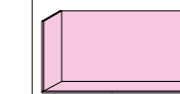

4
L W 84
P Dpt 19,8
H Ht 42

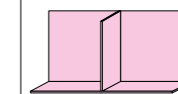

COD. VF16.43C VF16.44K VF16.45R VF16.46X

A

B

È un sistema di assemblaggio innovativo con cui puoi costruire i tuoi arredi con la stessa semplicità con cui assembleresti un gioco di costruzioni. Il connettore permette di fissare i nostri pannelli Sp 1,8 senza doverli forare; è dotato di una vite in acciaio inossidabile che, se stretta con l'uso di una brugola, blocca i pannelli come un morsetto evitando la perforazione degli stessi e l'uso di trapano o avvitatore, rendendo il montaggio semplice e veloce. La staffa-connettore PlayWood® è un morsetto dalle forme brevettate e caratterizzato da un design moderno. Realizzato in polimero rinforzato ultra resistente combinato con elementi in acciaio Inox, presenta un'elevata capacità di carico e può essere riutilizzato infinite volte.

It is an innovative assembly system, with which you can build your own furniture with the same simplicity of a construction game. The connector allows you to fix our Th 1.8 panels without having to drill them; it is equipped with a stainless steel screw which, if tightened with the use of an Allen key, locks the panels like a clamp avoiding their drilling and the use of a drill or screwdriver, making assembly quick and easy. The bracket-connector PlayWood® is a clamp with patented shapes and characterized by a modern design. Made of ultra-resistant reinforced polymer combined with stainless steel elements, it has a high load capacity and can be reused endless times.



Connettore 90°

Grazie alla loro conformazione, che permette di unire due pannelli tra loro con un angolo di 90°, puoi usare queste staffe-connettore per realizzare scaffali, sedute, scrivanie e librerie. Se utilizzate in coppia, poi, queste staffe possono formare una giunzione a T per fissare tre pannelli.

90° connector

Thanks to their conformation, which allows to connect two panels together at an angle of 90°, you can use these connector brackets to create shelves, seats, desks and bookcases. If used in pairs, then, these brackets can form a T-joint to fix three panels.



Connettore a Croce

Permette di unire contemporaneamente quattro pannelli tra loro con un angolo di 90°, creando una croce. Questo giunto a croce dispone di quattro innesti per creare velocemente e facilmente scaffalature e strutture che richiedono la combinazione di diversi pannelli. Questi connettori a croce sono utilizzati in combinazione con i connettori a 90°. Un connettore a croce assolve alla funzione di tre connettori 90° rendendo l'arredo più leggero.

Cross connector

It allows you to connect four panels together at a 90° angle, creating a cross. This cross connector has four couplings to quickly and easily create shelves and structures that require the combination of different panels. These cross connectors are used in combination with the 90° connectors. A cross connector performs the function of three 90° connectors making the furniture lighter.

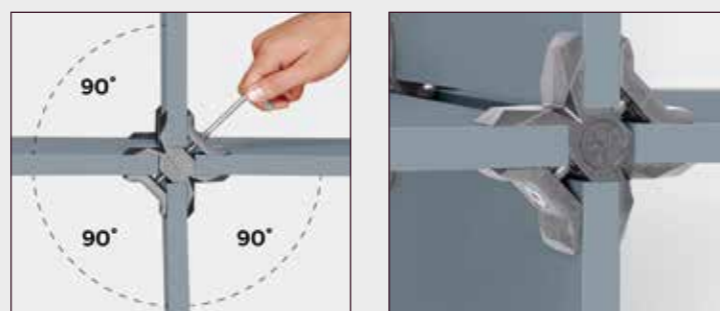

www.playwood.it

fornisce istruzioni, design e molto altro. Un supporto completo alla tua attività di progettazione. Ispirazioni e tutorial ti aiuteranno a costruire il tuo arredo.
provides instructions, designs and more. Complete support for your design activity. Inspirations and tutorials will help you build your furniture.



Posizionabili a terra

Positioned on the ground

	L W 48,3	L W 63,3	L W 93,4
H Ht 33,6			
COD.	VF16.60U	VF16.61A	VF16.62G
	(A)		
	(B)		

	L W 93,2	L W 123,2
H Ht 33,6		
COD.	VF16.63P	VF16.64V
	(A)	
	(B)	

	L W 138,1	L W 183,1
H Ht 33,6		
COD.	VF16.65B	VF16.66H
	(A)	
	(B)	

	L W 93,2	L W 123,2
H Ht 63,8		
COD.	VF16.67Q	VF16.68W
	(A)	
	(B)	

Articoli fusi

Bulk items

Connettore 90°
90° connector

Kit 8 pezzi - colore grigio
8-piece kit - gray color

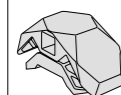

COD. VF16.55W

(A)

(B)

Connettore a Croce
Cross connector

Kit 2 pezzi - colore grigio
2-piece kit - gray color

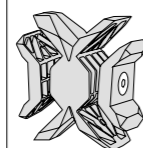

COD. VF16.56C

Pannello su misura per PlayWood®
Customized panel for PlayWood®

H Ht 86,4 Max
L W 44,7 Max
H Ht 26,6 Min
L W 26,6 Min
Sp Th 1,8

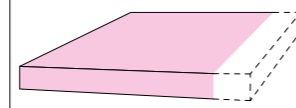

COD. VF16.57K

- Per la dimensione del pannello si consiglia di rispettare i limiti indicati. Carico massimo consigliato 30 Kg.
- L'altezza del pannello è definita dal disegno verticale della venatura del legno (se presente).
- For the size of the panel it is advisable to respect the limits indicated. 30 Kg maximum recommended load.
- Height of panel is defined by the vertical matching of the wood grain (if any).

Pannelli attrezzati STRIP - P 20

STRIP equipped panels - Dpt 20

- Elementi predisposti per le configurazioni presentate a listino
- In dotazione ferramenta per fissaggio a muro
- Mensole P 18; lamiera Sp 0,2

- Units designed for use in the configurations shown in the catalogue
- Supplied hardware for wall mounting
- Shelves Dpt 18; Sheet metal Th 0.2

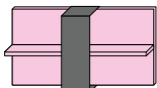
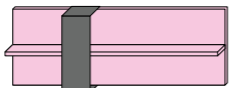
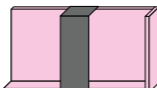
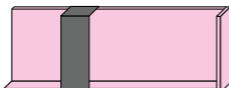
Inserto in metallo disponibile nei colori: Metal insert available in colors: B17A GZ8T		Mensola e pannello retro sempre dello stesso colore. Shelf and back panel always in the same color.	
	STRIP A L W 60 H Ht 32	STRIP B L W 90 H Ht 32	STRIP C L W 60 H Ht 32
			
	STRIP D L W 90 H Ht 32	Specificare Sx o Dx (disegno Dx) Specify L or R (R drawing)	
		Specificare Sx o Dx (disegno Dx) Specify L or R (R drawing)	
COD.	VF16.70Z	VF16.71F	VF16.83Z
	VF16.84F		
	(A)		
	(B)		

Pannelli attrezzati BING - P 28,5

BING equipped panels - Dpt 28.5

- In dotazione ferramenta per fissaggio a muro
- Mensole P 26

- Supplied hardware for wall mounting
- Shelves Dpt 26

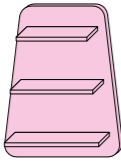
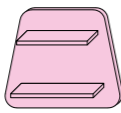
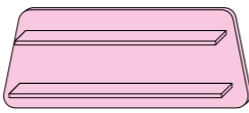
	BING A L W 53,8 H Ht 64	BING B L W 59 H Ht 41,6	BING C L W 103,7 H Ht 41,6
			
COD.	VF16.72N	VF16.73U	VF16.74A
	(A)		
	(B)		

Pannelli attrezzati DROP - P 20,5

DROP equipped panels - Dpt 20.5

- In dotazione ferramenta per fissaggio a muro
- Mensole P 18

- Supplied hardware for wall mounting
- Shelves Dpt 18

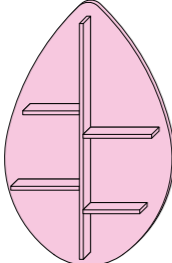
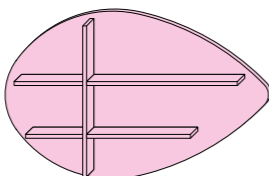
	DROP A L W 71 H Ht 111,7	DROP B L W 111,7 H Ht 71
		
COD.	VF16.75G	VF16.76P
	(A)	
	(B)	

Pannelli attrezzati EXPILON - P 28,5

EXPILON equipped panels - Dpt 28.5

- In dotazione ferramenta per fissaggio a muro
- Mensole P 26

- Supplied hardware for wall mounting
- Shelves Dpt 26

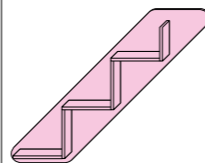
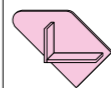
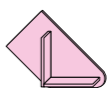
Componenti Components		EXPILON A		EXPILON B		EXPILON C	
		L W 129,3 H Ht 100,2	L W 64,6 H Ht 50,1	L W 64,6 H Ht 50,1	L W 64,6 H Ht 50,1	L W 64,6 H Ht 50,1	L W 64,6 H Ht 50,1
							
COD.		VF16.77V	VF16.78B	VF16.79H			
	(A)						
	(B)						

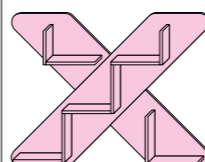
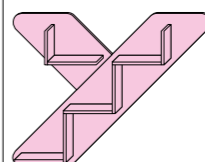
Composizioni Compositions		EXPILON X		EXPILON Y	
		L W 129,3 H Ht 100,2	L W 129,3 H Ht 100,2	L W 129,3 H Ht 100,2	L W 129,3 H Ht 100,2
					
COD.		VF16.80E	VF16.81M		
	(A)				
	(B)				

I componenti possono essere colorati a discrezione del cliente
I componenti possono essere colorati a discrezione del cliente

Esempio
Example

GIALLO ZAFFERANO GZ8A

BIANCO OPACO B17A

ALBICOCCA AB3C

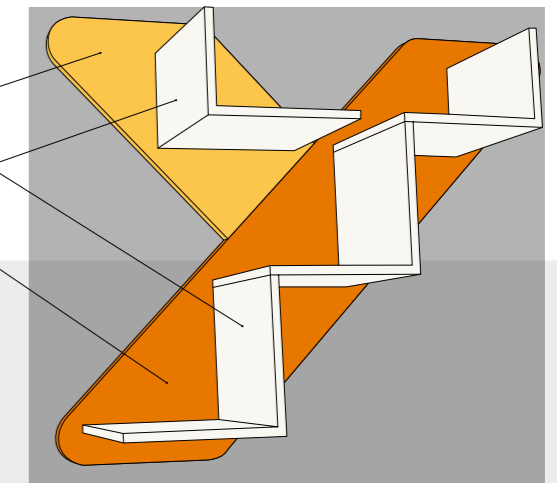

Misure d'ingombro
Overall dimensions

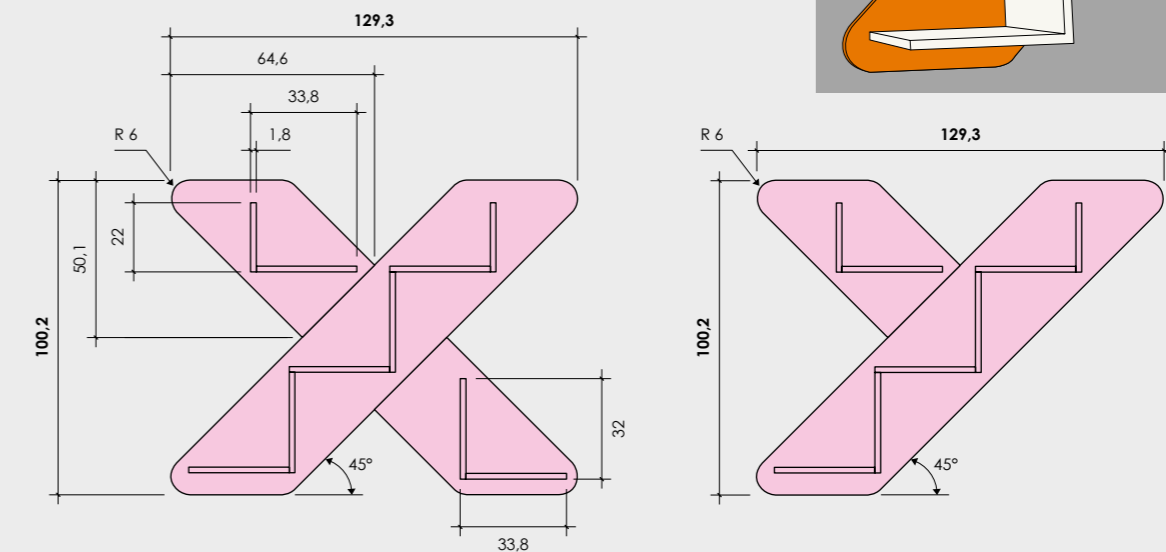

Pannelli attrezzati STRANGE - H 90

STRANGE equipped panels - Ht 90

- Elementi predisposti per le configurazioni presentate a listino
- In dotazione ferramenta per fissaggio a muro

- Units designed for use in the configurations shown in the catalogue
- Supplied hardware for wall mounting

	L W 90	L W 120	L W 135	Su misura Custom L W min 45 max 180
STRANGE Semplice senza fori Plain without drillings				
P Dpt 1,85				
COD.	VF16.85N	VF16.88G	VF16.91S	VF16.94M
	(A)			
	(B)			
STRANGE A Con mensole lineari P 26 With linear shelves Dpt 26				
P Dpt 28,3				
COD.	VF16.86U	VF16.89P	VF16.92Y	VF16.95T
	(A)			
	(B)			
STRANGE B Con mensola lineare, mensola a "L" e cubolotto ROBIN With linear shelf, "L" shelves and ROBIN cube				
P Dpt 33				
COD.	VF16.87A	VF16.90L	VF16.93E	
	(A)			
	(B)			

Accessori Accessories	Mensola lineare su misura Custom-made linear shelf	Coppia mensola a "L" Pair of "L" shelves	ROBIN cubolotto cube	Specchio Mirror	BOLLINO	PLUS
	L W min 45 max 180 P Dpt 26	L W 56 P Dpt 26 H Ht 15	L W 34 P Dpt 30,7 H Ht 32	Ø 30	Ø 4 P Dpt 10	L W 4,3 P Dpt 3 H Ht 6,5
COD.	VF16.96Z	VF16.97F	VF16.40H	VF34.39K	VF32.61Q	VF32.62W
	(A)					
	(B)					

● B17A AL1A

Pannelli attrezzati porta TV - H 90

Equipped panels for TV - Ht 90

- Pannello frontale Sp 1,8. Mensole Sp 2,5.
- Completi di attaccaglie per fissaggio a muro dotate di antiganciamento.
- Kit illuminazione opzionale costituito da: una strip LED, alimentatore e interruttore.
- Front panel Th 1,8. Shelves Th 2,5.
- Including wall-fastening hangers with anti-release mechanism.
- Optional lighting kit consisting of: one LED strip, power supply and switch.

	L W 90	L W 135	L W 150
P Dpt 27,8			
COD.	VF16.98N	VF16.99U	VF17.00R
SENZA illuminazione WITHOUT lighting	(A)		
	(B)		
CON illuminazione WITH lighting	(A)		
	(B)		

Misure d'ingombro Overall dimensions

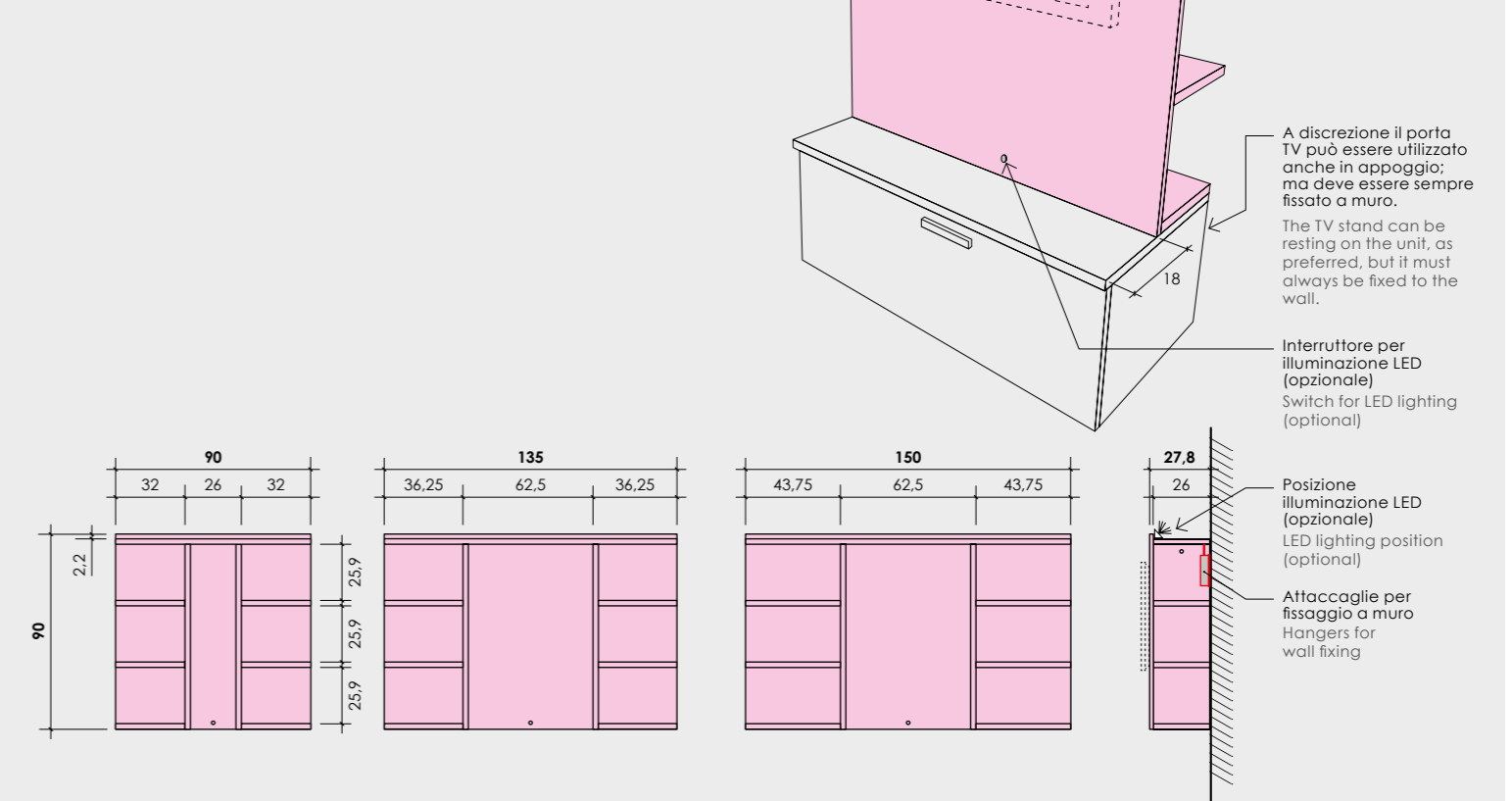

Facciate Fronts
VOLO

Finiture GRUPPO 1
GROUP 1 finishes

Finiture GRUPPO 2
GROUP 2 finishes

Rovere white*

A ☆ Rovere white RW3Q	A ☆ Rovere gesso RG9L	A ☆ Ciliegio bianco CB6K	A Grigio Dorian GL4R	B ☆ Cemento artico CA7A	B ☆ Rovere cognac RC3Q
B ☆ Royal oak RS4B	B Grigio titanio GZ8T	B Oliva LV5T	B Cadaques CQ3Q		
A Bianco opaco B17A	B Giallo zafferano GZ8A	B Albicocca AB3C	B Orchidea OR7L	B Blu Egeo EG4L	

Vetri Glass

Ante Doors
WINDOW

Colori telaio
Frame colours

Trasparente TR9M	Trasparente fumé FT8P	Stop sol ST6P	Specchio SP7L	Alluminio AL1A	Titan grey TG7H
----------------------------	---------------------------------	-------------------------	-------------------------	--------------------------	---------------------------

Rovere white* Finitura unica per tutti i componenti in pannello presenti a listino non evidenziati con il colore Finiture GRUPPO 1 e/o Finiture GRUPPO 2.
Unique finish for all the panel components shown in the pricelist not highlighted with the color finishes GROUP 1 and/or finishes GROUP 2.

- A** Finiture in fascia di prezzo A
Finishes in price range A
- B** Finiture in fascia di prezzo B
Finishes in price range B
- ☆ Finiture con effetto materico
Finishes with textured effect

LIBRERIA INFINITY
INFINITY BOOKSHELF

Libreria INFINITY - Informazioni tecniche INFINITY bookshelf - Technical information	pag. 176
Libreria INFINITY - Ante e cassetti INFINITY bookshelf - Doors and drawers	pag. 180
Libreria INFINITY - H 195,3 P 33,3 INFINITY bookshelf - Ht 195.3 Dpt 33.3	pag. 182
Libreria INFINITY - H 227,3 P 33,3 INFINITY bookshelf - Ht 227.3 Dpt 33.3	pag. 184
Libreria INFINITY - H 259,3 P 33,3 INFINITY bookshelf - Ht 259.3 Dpt 33.3	pag. 186
Libreria INFINITY - Schiene, ripiani e accessori INFINITY bookshelf - Backs, shelves and accessories	pag. 188
Libreria INFINITY angolo intero - P 33,3 Full corner INFINITY bookshelf - Dpt 33.3	pag. 190
Libreria INFINITY terminale - P 33,3 End-bookshelf INFINITY - Dpt 33.3	pag. 191

Libreria INFINITY - Informazioni tecniche

INFINITY bookshelf - Technical information

LARGHEZZE E PROFONDITÀ WIDTH AND DEPTH

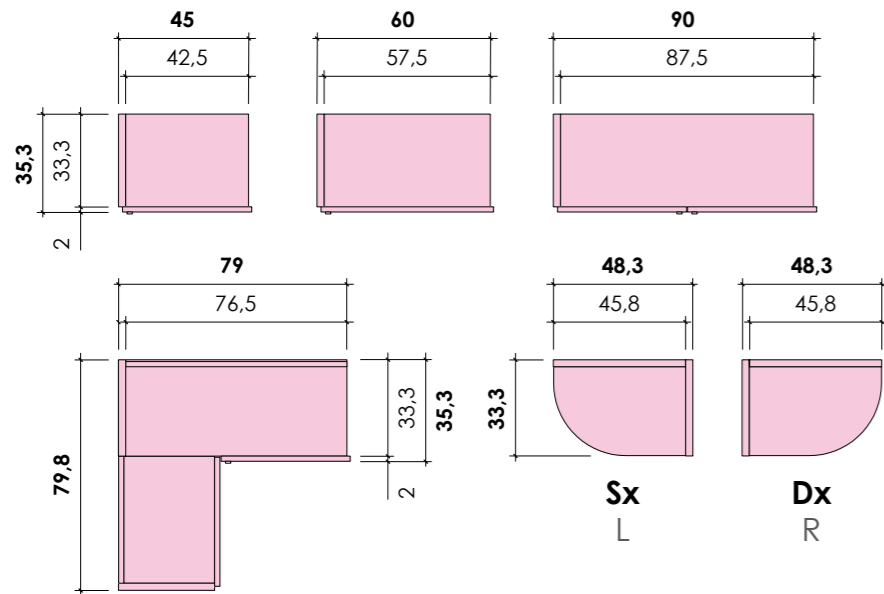

ALTEZZE

Il posizionamento standard del ripiano è a passo 32 cm. A richiesta c'è la possibilità di inserire un ripiano a passo 16 cm. Altezze comprensive di piedino regolabile H 0,8 cm.

HEIGHT

The standard distance between each shelf is 32 cm. Upon request, shelves can be positioned every 16 cm. Ht 0.8 cm adjustable foot included in heights.

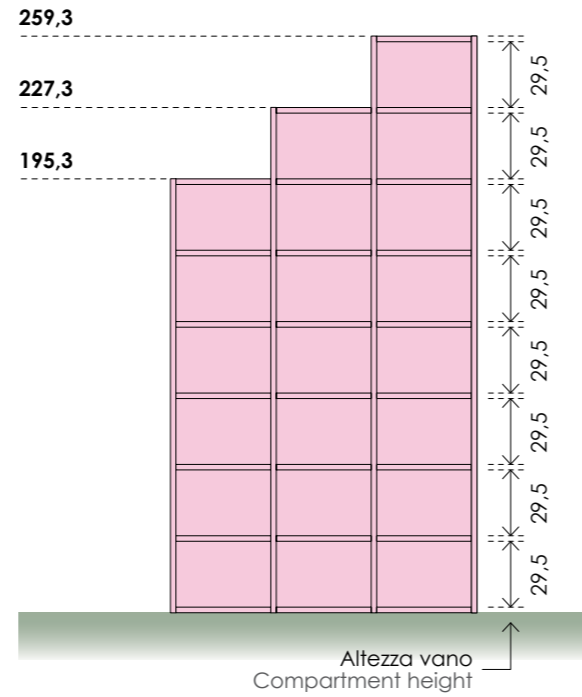

ALCUNI ESEMPI DI COMPONIBILITÀ SOME COMPOSITION EXAMPLES

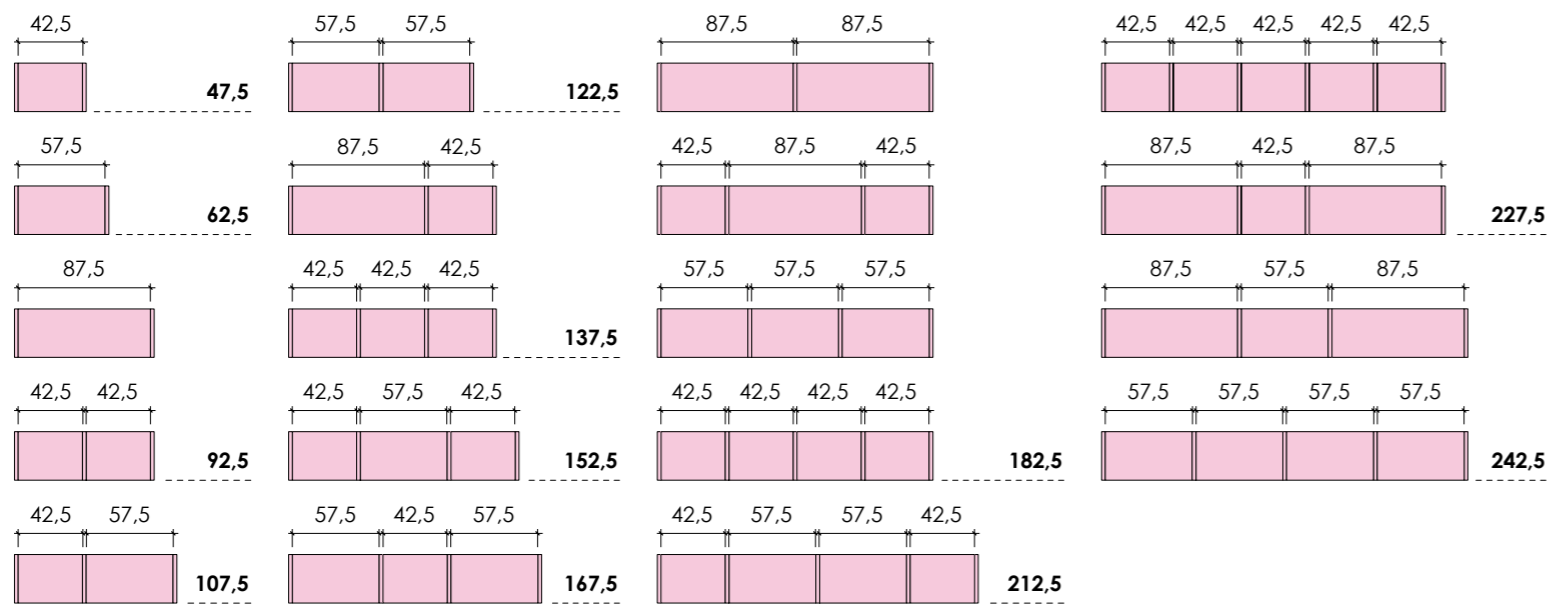

DISTANZE MINIME PER IL MONTAGGIO MINIMUM DISTANCES FOR ASSEMBLING

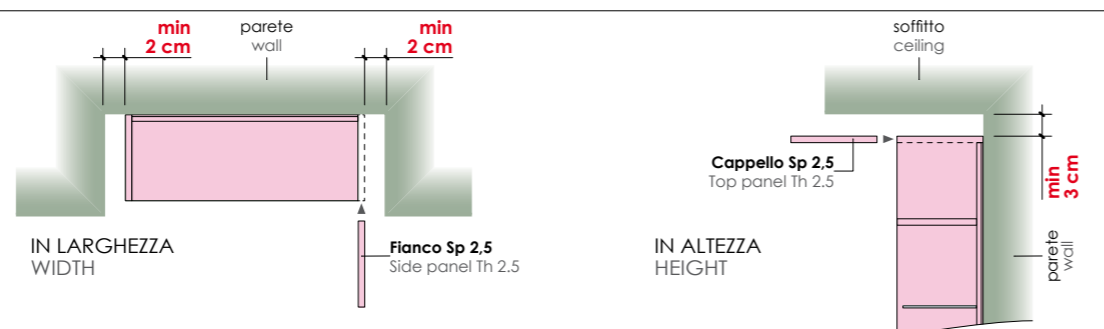

RIPIANO IN LEGNO CON LUCE LED

L'illuminazione per ripiano in legno è costituita da una strip led (60 led/mt) posizionata nella parte retro del ripiano. Lunga come tutto il ripiano, permette di illuminare riflettendosi nella schiena sia il vano superiore che inferiore. La tipologia di illuminazione è naturale. Si consiglia l'utilizzo di tale tipologia di illuminazione in presenza di schiena. Viene fornito un alimentatore (con sovrapprezzo) in grado di sostenere da 1 a 6 ripiani L 45/60 o da 1 a 4 ripiani L 90.

WOODEN SHELF WITH LED LIGHT

The wooden shelf light is a led strip (60 led/m) assembled on the back side of the shelf. The strip shares the same length with the shelf and by reflecting the light on the back panel, it enlightens the compartments above and below. The colour tone of the LED strip is natural. We recommend using this type of light system when there is a back panel. We provide a power pack (with a surcharge) able to support from 1 to 6 shelves W 45/60 or from 1 to 4 shelves W 90.

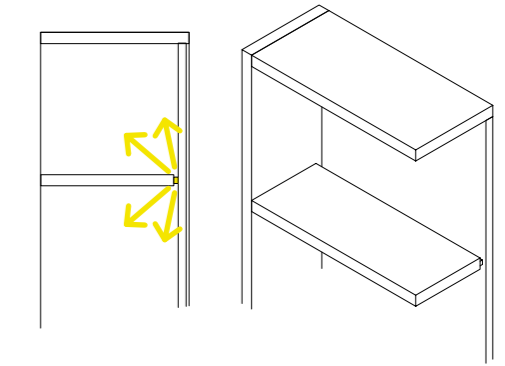

RIPIANO IN VETRO TRASPARENTE CON LUCE LED

L'illuminazione per ripiano in vetro è costituita da un profilo in PVC con strip led (60 led/mt), posizionata nella parte retro del ripiano. Lunga come tutto il ripiano, permette di illuminare riflettendosi nella schiena sia il vano superiore che inferiore, ma anche frontale. La tipologia di illuminazione è naturale. Si consiglia l'utilizzo di tale tipologia di illuminazione in presenza di schiena. Viene fornito un alimentatore (con sovrapprezzo) in grado di sostenere da 1 a 6 ripiani L 45/60 o da 1 a 4 ripiani L 90.

TRANSPARENT GLASS SHELF WITH LED LIGHT

The glass shelf light system consists in a PVC profile with led strip (60 led/m) assembled on the back side of the shelf. The strip shares the same length with the shelf, it gives a front lighting and by reflecting the light on the back panel, it enlightens the compartments above and below. The colour tone of the LED strip is natural. We recommend using this type of light system when there is a back panel. We provide a power pack (with a surcharge) able to support from 1 to 6 shelves W 45/60 or from 1 to 4 shelves W 90.

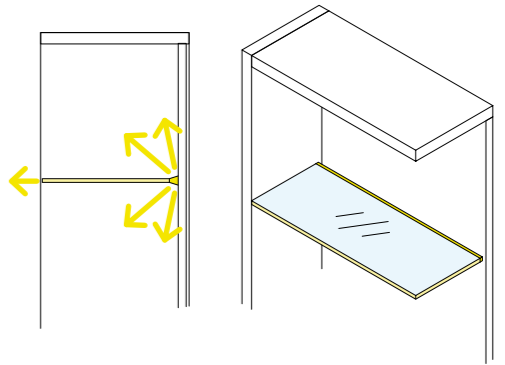

FARETTO LED

La tipologia di illuminazione è naturale. Viene fornito un alimentatore (con sovrapprezzo) in grado di sostenere da 1 a 6 faretti. Si consiglia l'utilizzo di tale tipologia di illuminazione nel cappello. I faretti vengono posizionati nel modo sotto indicato (cablaggi a vista).

LED SPOTLIGHT

The colour tone of the LED strip is natural. We provide a power pack (with a surcharge) able to support from 1 to 6 spotlights. We recommend using this type of light system only on top panel. Spotlights are assembled as showed below (wiring in sight).

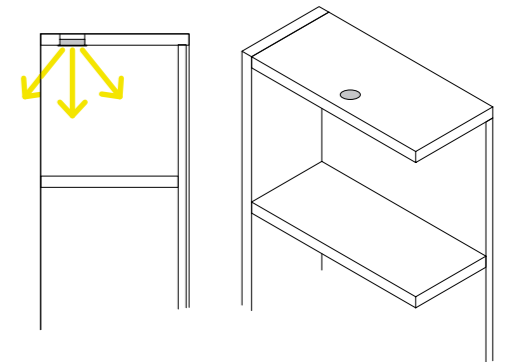
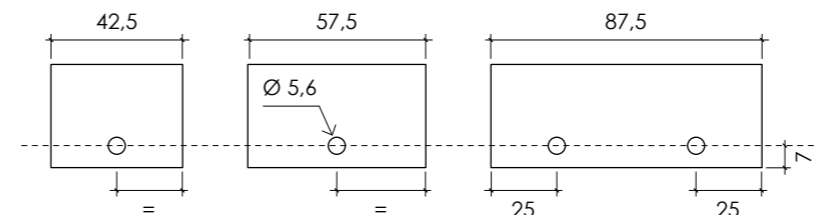

INTERRUTTORE

L'accensione di tali ripiani può avvenire in 2 modi:

ON/OFF SWITCH

The on/off switching of the shelves can be done in 2 different ways:

- 1) Collegando l'alimentatore alla spina di casa, usando come accensione l'interruttore di casa.

By connecting the power supply unit to your home electrical system and using your own standard power switch.

- 2) Ordinando un interruttore wireless presente nel listino.

Tale interruttore permette l'accensione o spegnimento di tutti i punti luce presenti nella libreria, contemporaneamente, sino ad un massimo di 30 ripiani o faretti. By ordering our wireless on/off switch from catalogue. This switch allows you to turn on or off all the LED lights in the bookcase, up to a maximum of 30 shelves or spotlights.

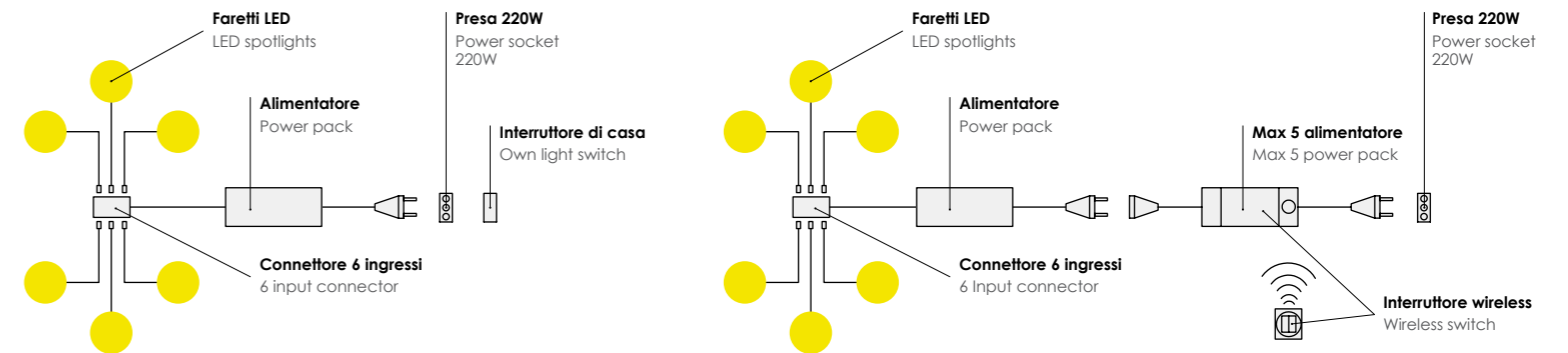

Libreria INFINITY - Ante e cassetti

INFINITY bookshelf - Doors and drawers

- Sono dotate di cerniere decelerate.
- Le ante VOLO sono disponibili anche con apertura PUSH-PULL.
- Su richiesta le ante VOLO possono essere fornite senza maniglia e senza fori maniglia.

- The doors are equipped with hinges decelerate.
- The VOLO doors are also available with PUSH-PULL opening.
- Upon request, the VOLO doors can be supplied without a handle and without handle holes.

- Le ante vasistas e ribalta sono dotate di cerniere a scomparsa e braccio di tipo meccanico modello snodo.
- Le ante VOLO vasistas e ribalta sono disponibili anche con apertura PUSH-PULL.

- The vasistas/folding doors are provided with concealed hinges and joint lid stay arm.
- The VOLO vasistas/folding doors can be supplied with PUSH-PULL system.

		Ante Doors							
L W	45								
		<p>Specificare cerniera Sx o Dx Specify hinge L or R</p>							
COD.		VF08.60Z	VF08.61F	VF08.62N	VF08.63U	VF08.64A	VF08.65G	VF08.66P	VF08.67V
VOLO		<input type="radio"/> A <input type="radio"/> B							
WINDOW									

		Ante Doors							
L W	60								
		<p>Specificare cerniera Sx o Dx Specify hinge L or R</p>							
COD.		VF08.68B	VF08.69H	VF08.70E	VF08.71M	VF08.72T	VF08.73Z	VF08.74F	VF08.75N
VOLO		<input type="radio"/> A <input type="radio"/> B							
WINDOW									

		Coppia ante Pair of doors							
L W	90								
COD.		VF10.26L	VF10.27S	VF10.28Y	VF10.29E	VF10.30B	VF10.31H	VF10.32Q	VF10.33W
VOLO		<input type="radio"/> A <input type="radio"/> B							
WINDOW									

		Coppia ante Pair of doors							
per Angoli interi for Corner wardrobes									
COD.		VF08.76U	VF08.77A	VF08.78G	VF08.79P	VF08.80L	VF08.81S	VF08.82Y	VF08.83E
VOLO		<input type="radio"/> A <input type="radio"/> B							

		Ante vasistas e a ribalta H 32	
Vasistas and folding doors Ht 32			
L W	45	<p>Specificare cerniera Sx o Dx Specify hinge L or R</p>	
COD.		VF08.84M	VF08.88N
VOLO		<input type="radio"/> A <input type="radio"/> B	

		Ante vasistas e a ribalta H 32	
Vasistas and folding doors Ht 32			
L W	60	<p>Specificare cerniera Sx o Dx Specify hinge L or R</p>	
COD.		VF08.85T	VF08.89U
VOLO		<input type="radio"/> A <input type="radio"/> B	

		Ante vasistas e a ribalta H 32	
Vasistas and folding doors Ht 32			
L W	90	<p>Specificare cerniera Sx o Dx Specify hinge L or R</p>	
COD.		VF08.86Z	VF08.90R
VOLO		<input type="radio"/> A <input type="radio"/> B	

		Ante vasistas e a ribalta H 32	
Vasistas and folding doors Ht 32			
L W	120	<p>Specificare cerniera Sx o Dx Specify hinge L or R</p>	
COD.		VF08.87F	VF08.91X
VOLO		<input type="radio"/> A <input type="radio"/> B	

- I cassetti sono dotati di guide metalliche tipo "QUADRO" a chiusura rallentata regolabili in altezza.

- Drawers are provided with "Quadro" metal runners which have adjustable height and soft close system.

		Cassetti H 16 - P 29,8		
Drawers Ht 16 - Dpt 29.8				
L W	45	<p>Specificare cerniera Sx o Dx Specify hinge L or R</p>		
COD.		VF08.92D	VF08.93L	VF08.94S
VOLO		<input type="radio"/> A <input type="radio"/> B		
L W	60	<p>Specificare cerniera Sx o Dx Specify hinge L or R</p>		
COD.		VF08.95Y	VF08.96E	VF08.97M
VOLO		<input type="radio"/> A <input type="radio"/> B		
L W	90	<p>Specificare cerniera Sx o Dx Specify hinge L or R</p>		
COD.		VF08.98T	VF08.99Z	VF09.00W
VOLO		<input type="radio"/> A <input type="radio"/> B		

ATTENZIONE:
Per un corretto funzionamento del sistema a ribalta o vasistas seguire le regole sotto riportate.

WARNING:
For a correct operation of folding and vasistas system, follow the instructions below.

Le ante ribalta/vasistas L 90 e 120 si possono montare anche su 2 elementi affiancati esclusivamente come da esempio.
Folding/vasistas doors W 90 and 120 can be mounted also on 2 juxtaposed elements exclusively as indicated in the example.

Libreria INFINITY - H 195,3 P 33,3

INFINITY bookshelf - Ht 195.3 Dpt 33.3

CON SCHIENA WITH BACK PANEL

L
W **45**

Specificare
cerniera Sx o Dx
Specify hinge
L or R

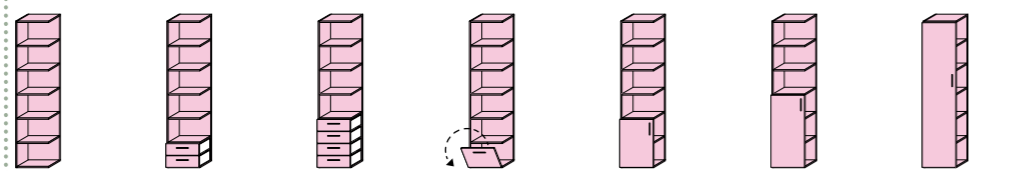

COD. VF08.00S VF09.04X VF09.05D VF09.06L VF09.07S VF09.08Y VF09.09E

VOLO A B

WINDOW A B

L
W **60**

Specificare
cerniera Sx o Dx
Specify hinge
L or R

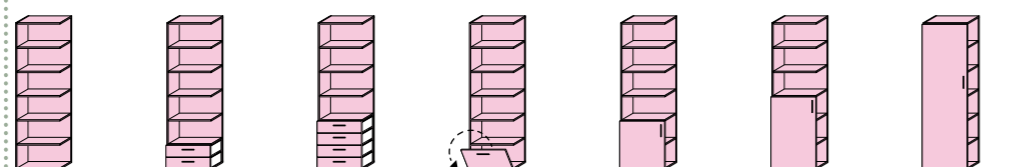

COD. VF08.03M VF09.10B VF09.11H VF09.12Q VF09.13W VF09.14C VF09.15K

VOLO A B

WINDOW A B

L
W **90**

Specificare
cerniera Sx o Dx
Specify hinge
L or R

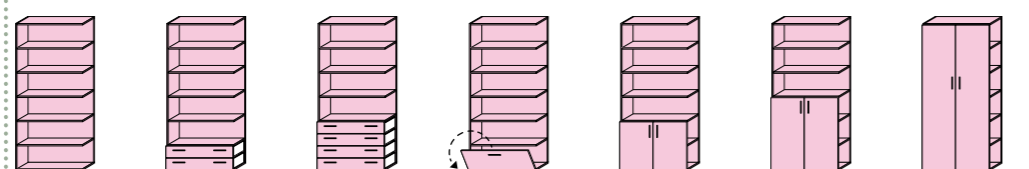

COD. VF08.06F VF09.26W VF09.27C VF09.28K VF09.29R VF09.30N VF09.31U

VOLO A B

WINDOW A B

PASSANTI SEE-THROUGH

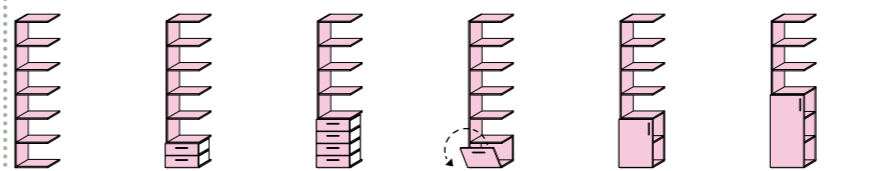

COD. VF08.09A VF09.16R VF09.17X VF09.18D VF09.19L VF09.20G

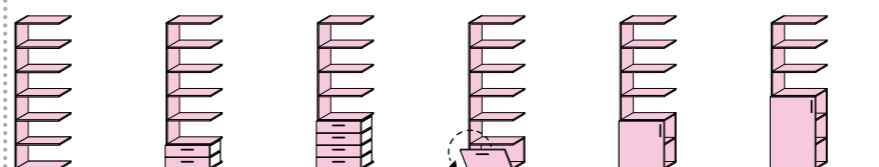

COD. VF08.12L VF09.21P VF09.22V VF09.23B VF09.24H VF09.25Q

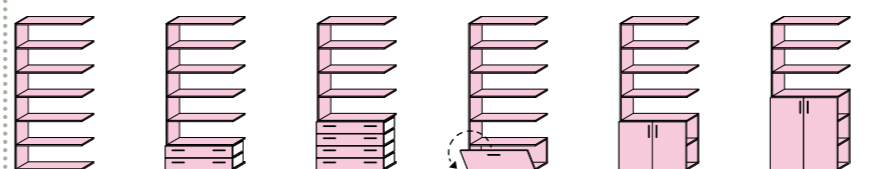

COD. VF08.15E VF09.32A VF09.33G VF09.34P VF09.35V VF09.36B

Fianco
(piede H 0.8 escluso)
Side panel
(Ht 0.8 foot not included)

H Ht 195,3
P Dpt 33,3
Sp Th 2,5

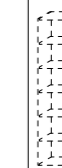

COD. VF08.42B

! Consigliamo l'utilizzo del nostro software grafico. È indispensabile graficare e/o inviare un disegno della composizione completa. Per la corretta personalizzazione dei fianchi si raccomanda di vestire i moduli librerie con ante, cassetti, ripiani e schiene. Tutte le composizioni devono essere completate con fianco finale.

We recommend using our graphic software. It is necessary to plot and/or send a drawing of the whole composition. For a correct customization of the side panels, we recommend you to integrate the modular bookcase units with doors, drawers, shelves and back panels. Each composition must be completed with end side panel.

pag. 40
pag. 180
pag. 188

Posizionamento pomelli e maniglie
Knobs and handles position
Ante e cassetti
Doors and drawers
Schiene e accessori
Backs and accessories

CON SCHIENA
 WITH BACK PANEL

L
W **45**

Specificare
cerniera Sx o Dx
Specify hinge
L or R

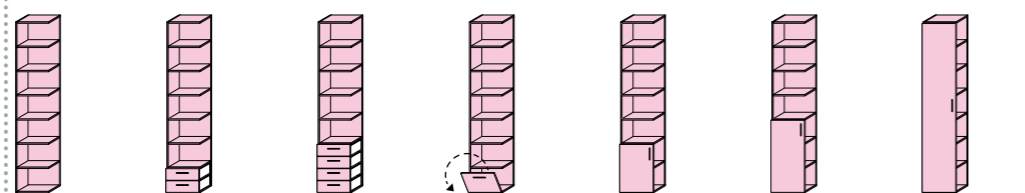

COD. VF08.01Y VF09.37H VF09.38Q VF09.39W VF09.40T VF09.41Z VF09.42F

VOLO (A) (B)
 WINDOW (A) (B)

L
W **60**

Specificare
cerniera Sx o Dx
Specify hinge
L or R

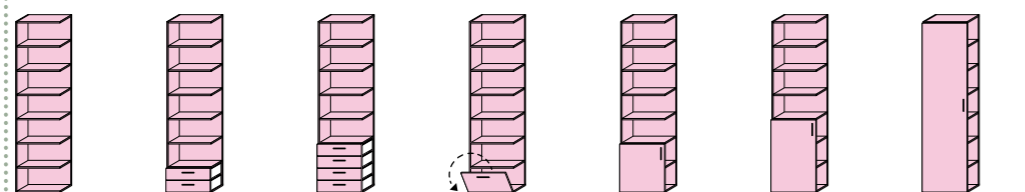

COD. VF08.04T VF09.43N VF09.44U VF09.45A VF09.46G VF09.47P VF09.48V

VOLO (A) (B)
 WINDOW (A) (B)

L
W **90**

Specificare
cerniera Sx o Dx
Specify hinge
L or R

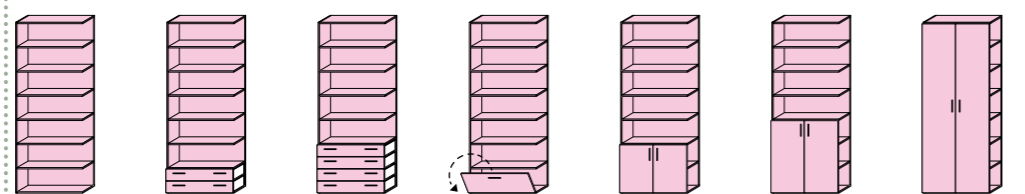

COD. VF08.07N VF09.59G VF09.60D VF09.61L VF09.62S VF09.63Y VF09.64E

VOLO (A) (B)
 WINDOW (A) (B)

PASSANTI
 SEE-THROUGH

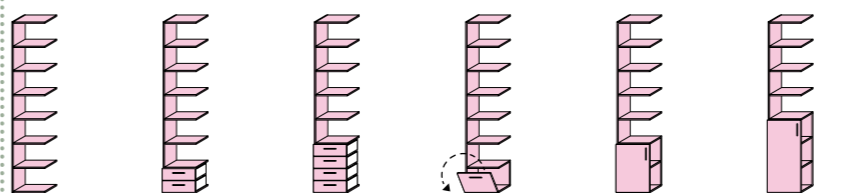

COD. VF08.10X VF09.49B VF09.50Y VF09.51E VF09.52M VF09.53T

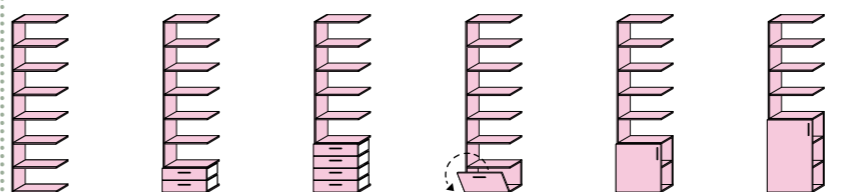

COD. VF08.13S VF09.54Z VF09.55F VF09.56N VF09.57U VF09.58A

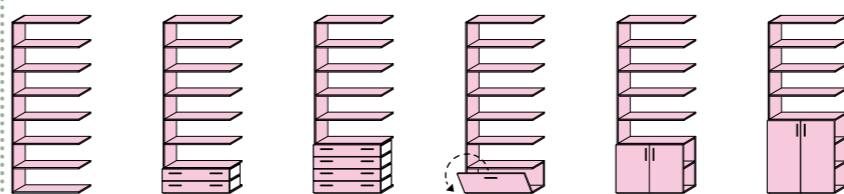

COD. VF08.16M VF09.65M VF09.66T VF09.67Z VF09.68F VF09.69N

Fianco
 (piede H 0.8 escluso)
 Side panel
 (Ht 0.8 foot not included)
 H Ht 227,3
 P Dpt 33,3
 Sp Th 2,5

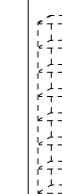

COD. VF08.43H

! Consigliamo l'utilizzo del nostro software grafico. È indispensabile graficare e/o inviare un disegno della composizione completa. Per la corretta personalizzazione dei fianchi si raccomanda di vestire i moduli librerie con ante, cassetti, ripiani e schiene. Tutte le composizioni devono essere completate con fianco finale.
 We recommend using our graphic software. It is necessary to plot and/or send a drawing of the whole composition. For a correct customization of the side panels, we recommend you to integrate the modular bookcase units with doors, drawers, shelves and back panels. Each composition must be completed with end side panel.

pag. 40
 pag. 180
 pag. 188

Posizionamento pomelli e maniglie
 Knobs and handles position
Ante e cassetti
 Doors and drawers
Schiene e accessori
 Backs and accessories

Libreria INFINITY - H 259,3 P 33,3
 INFINITY bookshelf - Ht 259.3 Dpt 33.3

CON SCHIENA
 WITH BACK PANEL

L
W **45**

Specificare
cerniera Sx o Dx
Specify hinge
L or R

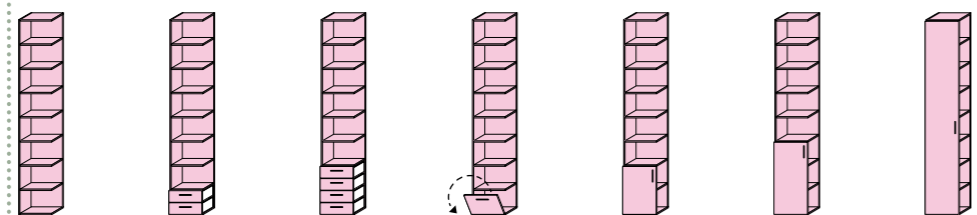

COD. VF08.02E VF09.70K VF09.71R VF09.72X VF09.73D VF09.74L VF09.75S

VOLO A B

WINDOW A B

L
W **60**

Specificare
cerniera Sx o Dx
Specify hinge
L or R

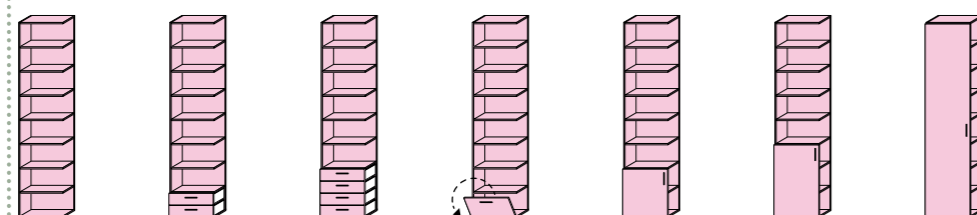

COD. VF08.05Z VF09.76Y VF09.77E VF09.78M VF09.79T VF09.80Q VF09.81W

VOLO A B

WINDOW A B

L
W **90**

Specificare
cerniera Sx o Dx
Specify hinge
L or R

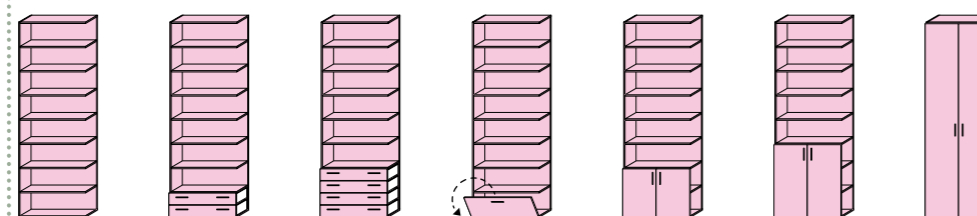

COD. VF08.08U VF09.92H VF09.93Q VF09.94W VF09.95C VF09.96K VF09.97R

VOLO A B

WINDOW A B

PASSANTI
 SEE-THROUGH

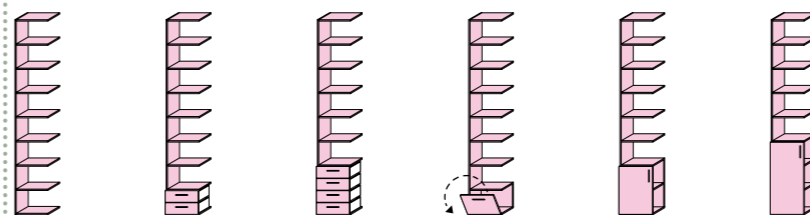

COD. VF08.11D VF09.82C VF09.83K VF09.84R VF09.85X VF09.86D

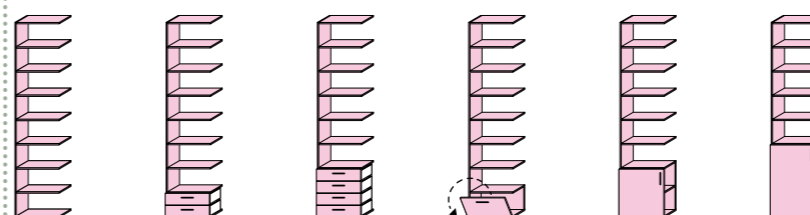

COD. VF08.14Y VF09.87L VF09.88S VF09.89Y VF09.90V VF09.91B

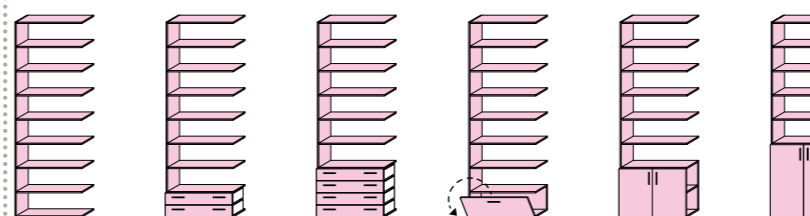

COD. VF08.17T VF09.98X VF09.99D VF10.00L VF10.01S VF10.02Y

Fianco
 (piede H 0.8 escluso)
 Side panel
 (Ht 0.8 foot not included)

H Ht 259,3
 P Dpt 33,3
 Sp Th 2,5

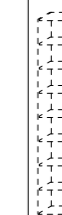

COD. VF08.44Q

! Consigliamo l'utilizzo del nostro software grafico. È indispensabile graficare e/o inviare un disegno della composizione completa. Per la corretta personalizzazione dei fianchi si raccomanda di vestire i moduli libreria con ante, cassetti, ripiani e schiene. Tutte le composizioni devono essere completate con fianco finale.
 We recommend using our graphic software. It is necessary to plot and/or send a drawing of the whole composition. For a correct customization of the side panels, we recommend you to integrate the modular bookcase units with doors, drawers, shelves and back panels. Each composition must be completed with end side panel.

pag. 40
 pag. 180
 pag. 188

Posizionamento pomelli e maniglie
 Knobs and handles position
Ante e cassetti
 Doors and drawers
Schiene e accessori
 Backs and accessories

Libreria INFINITY - Schiene, ripiani e accessori

INFINITY bookshelf - Backs, shelves and accessories

Schiene Sp 1,8

Backs Th 1.8

L
W **42,5**

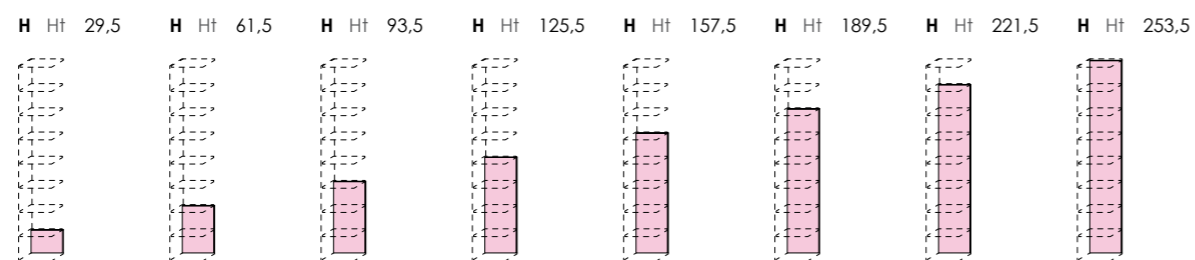

COD.	VF08.18Z	VF08.19F	VF08.20C	VF08.21K	VF08.22R	VF08.23X	VF08.24D	VF08.25L
VOLO	<div style="display: flex; justify-content: space-between; align-items: center;"> (A) (B) </div>							

Schiene Sp 1,8

Backs Th 1.8

L
W **57,5**

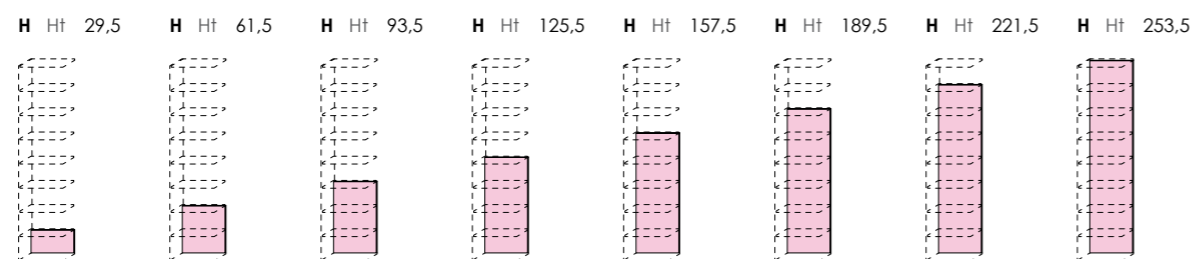

COD.	VF08.26S	VF08.27Y	VF08.28E	VF08.29M	VF08.30H	VF08.31Q	VF08.32W	VF08.33C
VOLO	<div style="display: flex; justify-content: space-between; align-items: center;"> (A) (B) </div>							

Schiene Sp 1,8

Backs Th 1.8

L
W **87,5**

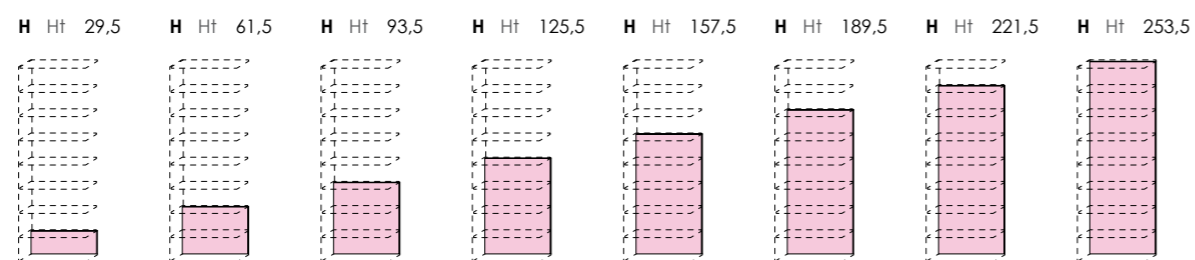

COD.	VF08.34K	VF08.35R	VF08.36X	VF08.37D	VF08.38L	VF08.39S	VF08.40P	VF08.41V
VOLO	<div style="display: flex; justify-content: space-between; align-items: center;"> (A) (B) </div>							

Ripiani mobili in nobilitato

Melamine-coated movable shelves

Sp
Th **2,5**

L W 42,5	COD.	P Dpt 30,8 Per Librerie con schiena For Bookcases with back	P Dpt 33,3 Per Librerie passanti For See-through bookcases	P Dpt 29,8 Per Librerie con schiena For Bookcases with back
L W 57,5	COD.	VF08.45W	VF08.46C	VF08.47K
		<div style="display: flex; justify-content: space-between; align-items: center;">(A)(B)</div>		
L W 87,5	COD.	VF08.50U	VF08.51A	VF08.52G
		<div style="display: flex; justify-content: space-between; align-items: center;">(A)(B)</div>		
	COD.	VF08.55B	VF08.56H	VF08.57Q
		<div style="display: flex; justify-content: space-between; align-items: center;">(A)(B)</div>		

Ripiani mobili in vetro trasparente

Transparent glass movable shelves

Sp
Th **0,8**

L W 42,5	COD.	P Dpt 28,5 Per Librerie con schiena e librerie passanti For Bookcases with back and see-through bookcases	P Dpt 28,5 Per Librerie con schiena For Bookcases with back
L W 57,5	COD.	VF08.48R	VF08.49X
		<div style="display: flex; justify-content: space-between; align-items: center;">(A)(B)</div>	
L W 87,5	COD.	VF08.53P	VF08.54V
		<div style="display: flex; justify-content: space-between; align-items: center;">(A)(B)</div>	
	COD.	VF08.58W	VF08.59C
		<div style="display: flex; justify-content: space-between; align-items: center;">(A)(B)</div>	

Faretto LED Ø 6,5
LED spotlights Ø 6.5
12 volt 1,7 watt.

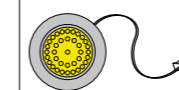

COD. **VF32.55L**

Interruttore wireless
Wireless switch
Per illuminazione LED.
(utilizzabile sia per ripiani che per faretto).
For LED lighting (usable for shelves and spotlight).

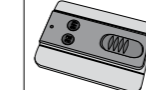

COD. **VF32.57Y**

! Consigliamo l'utilizzo del nostro software grafico. È indispensabile graficare e/o inviare un disegno della composizione completa. Per la corretta personalizzazione dei fianchi si raccomanda di vestire i moduli libreria con ante, cassetti, ripiani e schiene. Tutte le composizioni devono essere completate con fianco finale.

We recommend using our graphic software. It is necessary to plot and/or send a drawing of the whole composition. For a correct customization of the side panels, we recommend you to integrate the modular bookcase units with doors, drawers, shelves and back panels. Each composition must be completed with end side panel.

Libreria INFINITY angolo intero - P 33,3
Full corner INFINITY bookshelf - Dpt 33.3

CON SCHIENA
WITH BACK PANEL

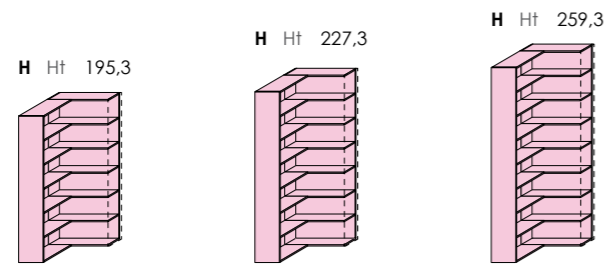

COD. VF10.09U VF10.10R VF10.11X

A
B

Ripiani mobili
Movable shelves

In nobilitato
Melamine-coated

Sp Th 2,5
P Dpt 30,8

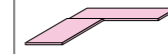

COD. VF10.23R

PASSANTI
SEE-THROUGH

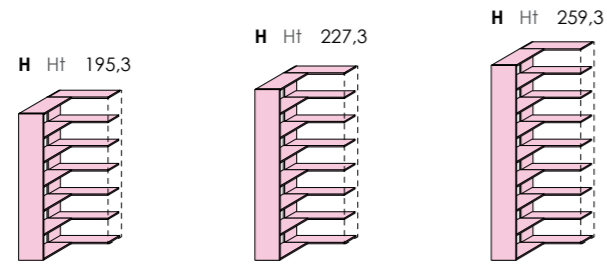

COD. VF10.12D VF10.13L VF10.14S

A
B

In nobilitato
Melamine-coated

Sp Th 2,5
P Dpt 33,3

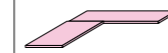

COD. VF10.24X

Fianchi
(piede H 0,8 escluso)
Side panels
(Ht 0.8 foot not included)

Sp Th 2,5

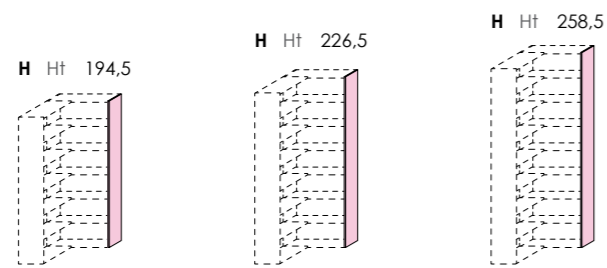

COD. VF08.42B VF08.43H VF08.44Q

A
B

INFORMAZIONI TECNICHE

Disponibile nella versione a giorno oppure con coppia ante. La maniglia è posizionata sempre sull'anta Dx.
Non è possibile invertire gli ingombri.

TECHNICAL INFORMATION

Available in open version or with pair of doors. Handle is always provided on the Right door. Size proportion changes are not available.

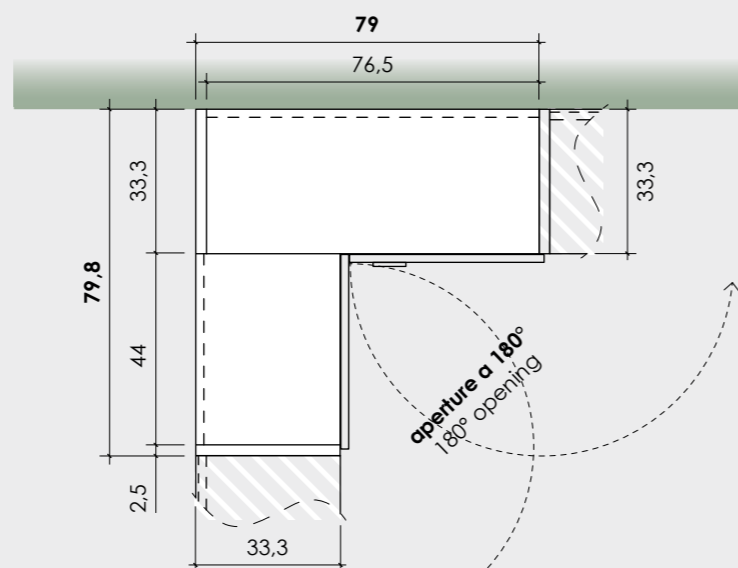

Libreria INFINITY terminale - P 33,3
End-bookshelf INFINITY - Dpt 33.3

Ripiano mobile
Movable shelf

In nobilitato
Melamine-coated

Sp Th 2,5
P Dpt 30,8

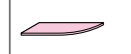

COD. VF10.25D

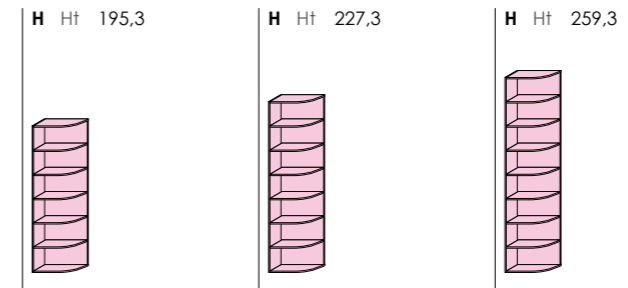

COD. VF10.18T VF10.19Z VF10.20W

A
B

INFORMAZIONI TECNICHE
Disponibile solo nella versione a giorno.

TECHNICAL INFORMATION
Available only in open version.

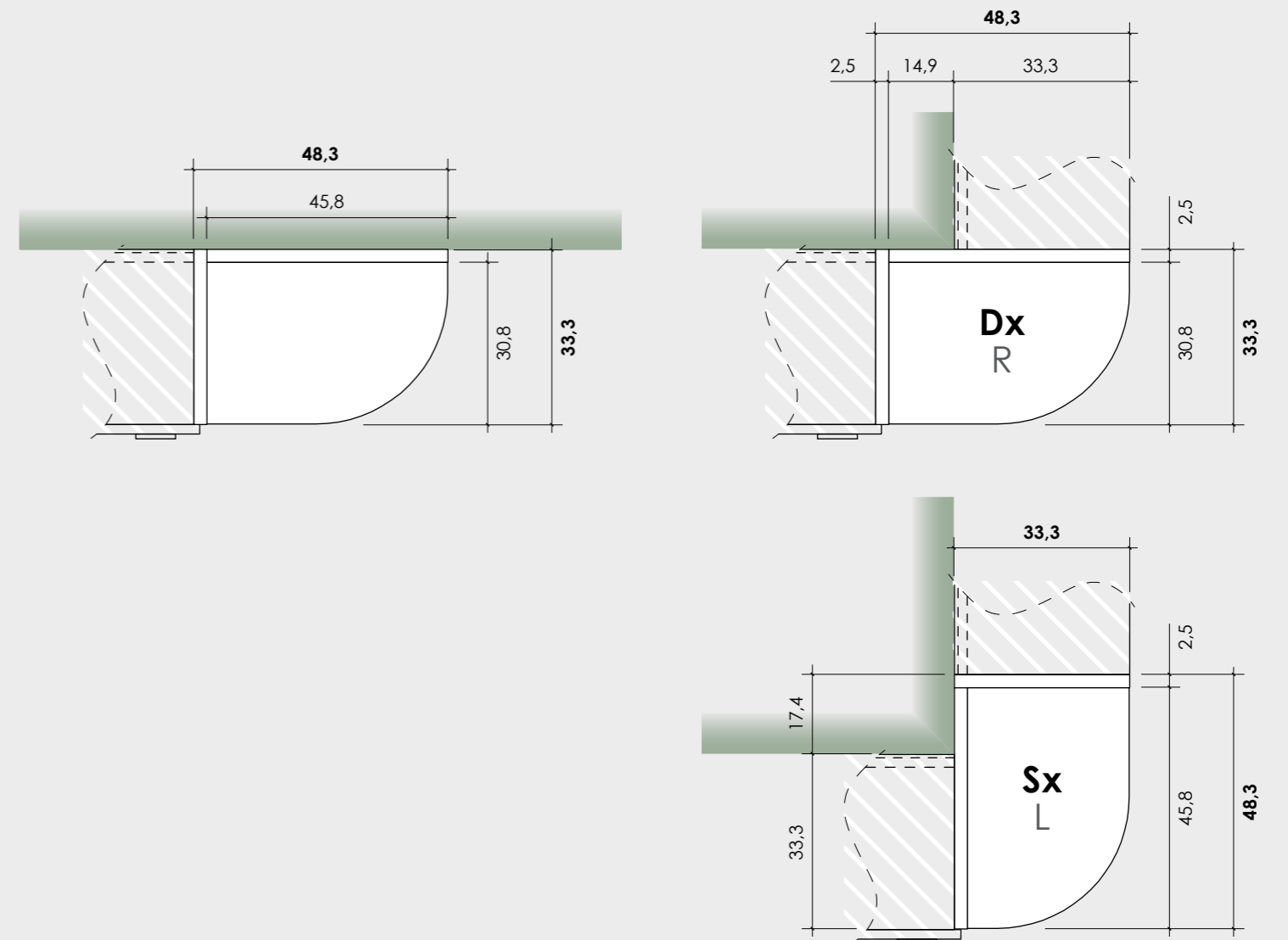

! Consigliamo l'utilizzo del nostro software grafico. È indispensabile graficare e/o inviare un disegno della composizione completa. Per la corretta personalizzazione dei fianchi si raccomanda di vestire i moduli librerie con ante, cassetti, ripiani e schiene. Tutte le composizioni devono essere completate con fianco finale.

We recommend using our graphic software. It is necessary to plot and/or send a drawing of the whole composition. For a correct customization of the side panels, we recommend you to integrate the modular bookcase units with doors, drawers, shelves and back panels. Each composition must be completed with end side panel.

Facciate Fronts
VOLO

Finiture GRUPPO 1
GROUP 1 finishes

Finiture GRUPPO 2
GROUP 2 finishes

Rovere white*

A ☆ Rovere white RW3Q	A ☆ Rovere gesso RG9L	A ☆ Ciliegio bianco CB6K	A Grigio Dorian GL4R	B ☆ Cemento antico CA7A	B ☆ Rovere cognac RC3Q
B ☆ Royal oak RS4B	B Grigio titanio GZ8T	B Oliva LV5T	B Cadaques CQ3Q		
A Bianco opaco B17A	B Giallo zafferano GZ8A	B Albicocca AB3C	B Orchidea OR7L	B Blu Egeo EG4L	

Vetri Glass

Ante Doors
WINDOW

Colori telaio
Frame colours

Trasparente TR9M	Trasparente fumé FT8P	Stop sol ST6P	Specchio SP7L	Alluminio AL1A	Titan grey TG7H
----------------------------	---------------------------------	-------------------------	-------------------------	--------------------------	---------------------------

Rovere white* Finitura unica per tutti i componenti in pannello presenti a listino non evidenziati con il colore Finiture GRUPPO 1 e/o Finiture GRUPPO 2.
Unique finish for all the panel components shown in the pricelist not highlighted with the color finishes GROUP 1 and/or finishes GROUP 2.

- A** Finiture in fascia di prezzo A
Finishes in price range A
- B** Finiture in fascia di prezzo B
Finishes in price range B
- ☆ Finiture con effetto materico
Finishes with textured effect

COMPONIBILI E PENSILI
MODULAR UNITS AND HANGING UNITS

Componibili a terra/in appoggio - P 45,8 Floor/support modular units - Dpt 45.8	pag. 194
Componibili sospesi - P 45,8 Suspended modular units - Dpt 45.8	pag. 200
Accessori per componibili Modular units accessories	pag. 202
Pensili - P 32,5 Hanging units - Dpt 32.5	pag. 204
Accessori per pensili Hanging units accessories	pag. 206
Moduli sospesi SNAKE SNAKE suspended modular units	pag. 208

Componibili a terra/in appoggio - P 45,8

Floor/support modular units - Dpt 45.8



- Completare ogni composizione con top e piedi o con top e base.
- Sono compresi ripiani interni ogni 32 cm.
- Per una corretta foratura del top è indispensabile inviare un disegno.

- Complete each composition with top and feet or top and base.
- Inner shelves included every 32 cm.
- It is essential to send a drawing to enable us to drill the top as appropriate.

	H Ht 32								H Ht 64								H Ht 96	
L W 45																		
Specificare cerniera Sx o Dx Specify hinge L or R																		
COD.	VF11.00Q	VF11.01W	VF11.02C	VF11.03K	VF11.04R	VF11.05X	VF11.06D	VF11.07L	VF11.08S	VF11.09Y	VF11.10V	VF11.11B	VF11.12H	VF11.13Q	VF11.14W	VF11.15C	VF24.00F	VF24.01N
VOLO	(A)	(B)	(A)	(B)	(A)	(B)	(A)	(B)	(A)	(B)	(A)	(B)	(A)	(B)	(A)	(B)	(A)	(B)
WINDOW	(A)	(B)	(A)	(B)	(A)	(B)	(A)	(B)	(A)	(B)	(A)	(B)	(A)	(B)	(A)	(B)	(A)	(B)
L W 60																		
Specificare cerniera Sx o Dx Specify hinge L or R																		
COD.	VF11.20A	VF11.21G	VF11.22P	VF11.23V	VF11.24B	VF11.25H	VF11.26Q	VF11.27W	VF11.28C	VF11.29K	VF11.30F	VF11.31N	VF11.32U	VF11.33A	VF11.34G	VF11.35P	VF24.40C	VF24.41K
VOLO	(A)	(B)	(A)	(B)	(A)	(B)	(A)	(B)	(A)	(B)	(A)	(B)	(A)	(B)	(A)	(B)	(A)	(B)
WINDOW	(A)	(B)	(A)	(B)	(A)	(B)	(A)	(B)	(A)	(B)	(A)	(B)	(A)	(B)	(A)	(B)	(A)	(B)
L W 90																		
Specificare cerniera Sx o Dx Specify hinge L or R																		
COD.	VF11.40M	VF11.41T	VF11.42Z	VF11.43F	VF11.44N	VF11.45U	VF11.46A	VF11.47G	VF11.48P	VF11.49V	VF11.50S	VF11.51Y	VF11.52E	VF11.53M	VF11.54T	VF11.55Z	VF24.80Z	VF24.81F
VOLO	(A)	(B)	(A)	(B)	(A)	(B)	(A)	(B)	(A)	(B)	(A)	(B)	(A)	(B)	(A)	(B)	(A)	(B)
WINDOW	(A)	(B)	(A)	(B)	(A)	(B)	(A)	(B)	(A)	(B)	(A)	(B)	(A)	(B)	(A)	(B)	(A)	(B)

Frontali disponibili con apertura PUSH-PULL (no WINDOW)
Fronts available with PUSH-PULL opening (not WINDOW)

pag. 40
pag. 202

Posizionamento pomelli e maniglie
Knobs and handles position
Accessori per componibili
Modular units accessories

Componibili a terra/in appoggio - P 45,8

Floor/support modular units - Dpt 45.8



- Completare ogni composizione con top e piedi o con top e base.
- Sono compresi ripiani interni ogni 32 cm.
- Per una corretta foratura del top è indispensabile inviare un disegno.

- Complete each composition with top and feet or top and base.
- Inner shelves included every 32 cm.
- It is essential to send a drawing to enable us to drill the top as appropriate.

H
Ht 96

H
Ht 128

L
W 45

Specificare
cerniera Sx o Dx
Specify hinge
L or R

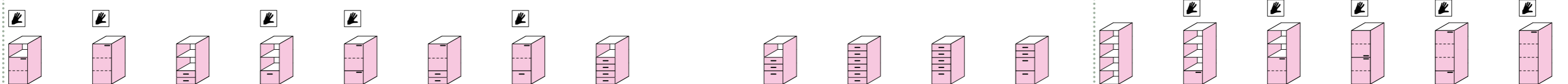

COD. VF24.02U VF24.03A VF24.04G VF24.05P VF24.06V VF24.07B VF24.08H VF24.09Q VF24.10M VF24.11T VF24.12Z VF24.13F VF24.14N VF24.15U VF24.16A VF24.17G VF24.18P VF24.19V

VOLO (A) (B)

WINDOW (A) (B)

L
W 60

Specificare
cerniera Sx o Dx
Specify hinge
L or R

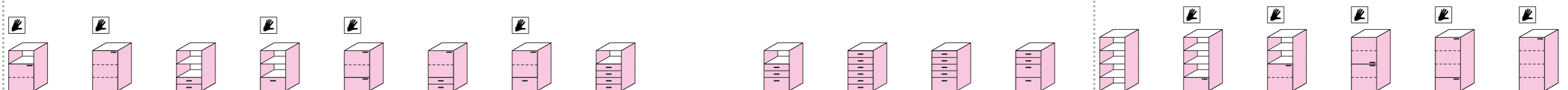

COD. VF24.42R VF24.43X VF24.44D VF24.45L VF24.46S VF24.47Y VF24.48E VF24.49M VF24.50H VF24.51Q VF24.52W VF24.53C VF24.54K VF24.55R VF24.56X VF24.57D VF24.58L VF24.59S

VOLO (A) (B)

WINDOW (A) (B)

L
W 90

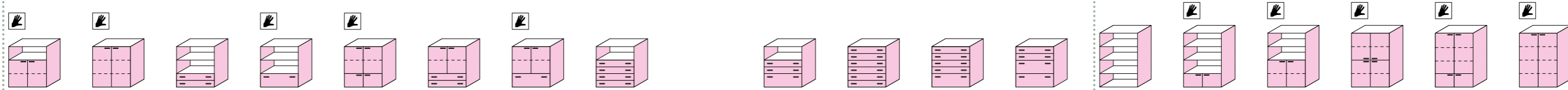

COD. VF24.82N VF24.83U VF24.84A VF24.85G VF24.86P VF24.87V VF24.88B VF24.89H VF24.90E VF24.91M VF24.92T VF24.93Z VF24.94F VF24.95N VF24.96U VF24.97A VF24.98G VF24.99P

VOLO (A) (B)

WINDOW (A) (B)

Frontali disponibili con apertura PUSH-PULL (no WINDOW)
Fronts available with PUSH-PULL opening (not WINDOW)

pag. 40
pag. 202

Posizionamento pomelli e maniglie
Knobs and handles position
Accessori per componibili
Modular units accessories

Componibili a terra/in appoggio - P 45,8

Floor/support modular units - Dpt 45.8

- Completare ogni composizione con top e piedi o con top e base.
- Sono compresi ripiani interni ogni 32 cm.
- Per una corretta foratura del top è indispensabile inviare un disegno.

- Complete each composition with top and feet or top and base.
- Inner shelves included every 32 cm.
- It is essential to send a drawing to enable us to drill the top as appropriate.

H
Ht 128

L
W 45

Specificare
cerniera Sx o Dx
Specify hinge
L or R

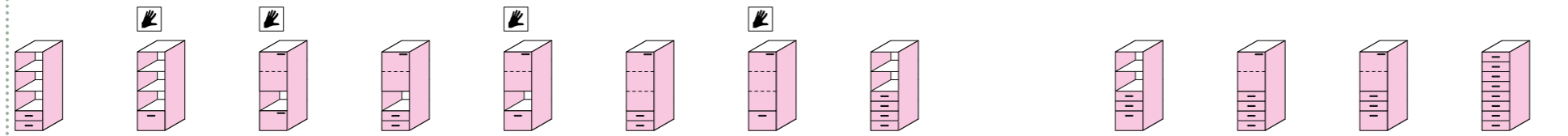

COD.	VF24.20S	VF24.21Y	VF24.22E	VF24.23M	VF24.24T	VF24.25Z	VF24.26F	VF24.27N	VF24.28U	VF24.29A	VF24.30X	VF24.31D
VOLO	(A)	(B)	(A)	(B)	(A)	(B)	(A)	(B)	(A)	(B)	(A)	(B)
WINDOW	(A)	(B)	(A)	(B)	(A)	(B)	(A)	(B)	(A)	(B)	(A)	(B)

L
W 60

Specificare
cerniera Sx o Dx
Specify hinge
L or R

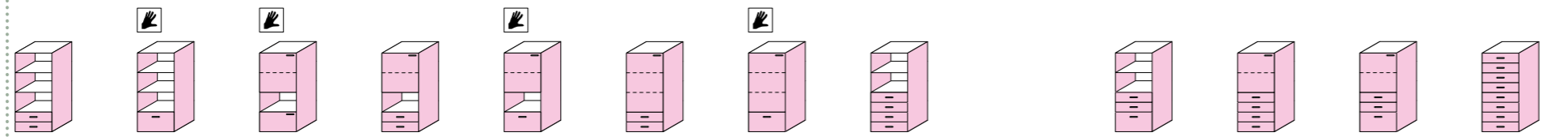

COD.	VF24.60P	VF24.61V	VF24.62B	VF24.63H	VF24.64Q	VF24.65W	VF24.66C	VF24.67K	VF24.68R	VF24.69X	VF24.70U	VF24.71A
VOLO	(A)	(B)	(A)	(B)	(A)	(B)	(A)	(B)	(A)	(B)	(A)	(B)
WINDOW	(A)	(B)	(A)	(B)	(A)	(B)	(A)	(B)	(A)	(B)	(A)	(B)

L
W 90

Specificare
cerniera Sx o Dx
Specify hinge
L or R

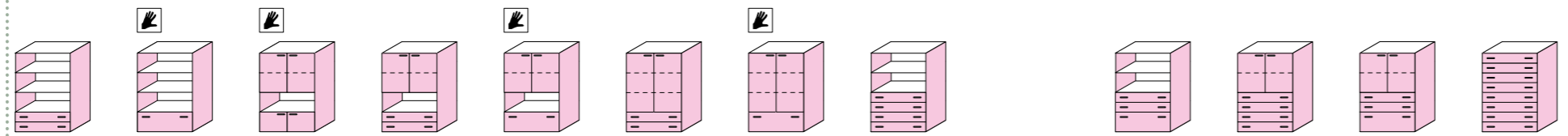

COD.	VF25.00L	VF25.01S	VF25.02Y	VF25.03E	VF25.04M	VF25.05T	VF25.06Z	VF25.07F	VF25.08N	VF25.09U	VF25.10R	VF25.11X
VOLO	(A)	(B)	(A)	(B)	(A)	(B)	(A)	(B)	(A)	(B)	(A)	(B)
WINDOW	(A)	(B)	(A)	(B)	(A)	(B)	(A)	(B)	(A)	(B)	(A)	(B)

Frontali disponibili con apertura PUSH-PULL (no WINDOW)
Fronts available with PUSH-PULL opening (not WINDOW)

pag. 40
pag. 202

Posizionamento pomelli e maniglie
Knobs and handles position
Accessori per componibili
Modular units accessories

Componibili sospesi - P 45,8

Suspended modular units - Dpt 45.8

- **Completare ogni composizione con top.**
- Sono completi di attaccaglie per fissaggio al muro dotate di antiganciamento.
- Sono compresi ripiani interni ogni 32 cm.
- Per una corretta foratura del top è indispensabile inviare un disegno.



- **Complete each composition with top.**
- They are complete with hangers for fixing to a wall equipped with fischer screws.
- Inner shelves included every 32 cm.
- It is essential to send a drawing to enable us to drill the top as appropriate.

	H Ht 32									H Ht 64						
L W 45																
COD.	VF12.00U	VF12.01A	VF12.02G	VF12.03P	VF12.04V	VF12.05B	VF12.06H	VF12.07Q	VF12.08W	VF25.20W	VF25.21C	VF25.22K	VF25.23R	VF25.24X	VF25.25D	VF25.26L
VOLO	(A)	(B)														
WINDOW	(A)	(B)														
L W 60																
COD.	VF12.10Z	VF12.11F	VF12.12N	VF12.13U	VF12.14A	VF12.15G	VF12.16P	VF12.17V	VF12.18B	VF25.30B	VF25.31H	VF25.32Q	VF25.33W	VF25.34C	VF25.35K	VF25.36R
VOLO	(A)	(B)														
WINDOW	(A)	(B)														
L W 90																
COD.	VF12.20E	VF12.21M	VF12.22T	VF12.23Z	VF12.24F	VF12.25N	VF12.26U	VF12.27A	VF12.28G	VF25.40G	VF25.41P	VF25.42V	VF25.43B	VF25.44H	VF25.45Q	VF25.46W
VOLO	(A)	(B)														
WINDOW	(A)	(B)														

Frontali disponibili con apertura PUSH-PULL (no WINDOW)
Fronts available with PUSH-PULL opening (not WINDOW)

pag. 40
pag. 202

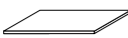
Posizionamento pomelli e maniglie
Knobs and handles position
Accessori per componibili
Modular units accessories

	Ripiani interni Inner shelves	Ripiani interni in vetro trasparente Transparent glass inner shelves Solo ripiani a vista e ripiani all'interno delle ante Only shelves in open units and shelves within doors	Ripiani interni con led Inner shelves with led Da completare con alimentatore COD. VF32.56S To be completed with power pack COD. VF32.56S
	Sp Th 2,5 P Dpt 41,7 L W 41,3 56,3 86,3	Sp Th 0,8 P Dpt 41,2 L W 41,3 56,3 86,3	Sp Th 2,5 P Dpt 40,7 L W 41,3 56,3 86,3
			
L W	COD.	COD.	COD.
45	VF34.56A	VF34.59V	VF34.62E
60	VF34.57G	VF34.60S	VF34.63M
90	VF34.58P	VF34.61Y	VF34.64T

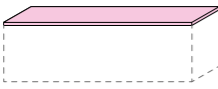
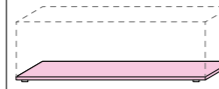
	Top Sp 2,5 - P 45,8 Top Th 2,5 - Dpt 45,8	Base H 3 - P 45,8 Base Ht 3 - Dpt 45,8
		
L W	COD.	COD.
45	(A) VF11.60X (B) VF11.60Y	VF11.70C
60	(A) VF11.61D (B) VF11.61E	VF11.71K
90	(A) VF11.62L (B) VF11.62M	VF11.72R
120	(A) VF11.63S (B) VF11.63T	VF11.73X
135	(A) VF11.64Y (B) VF11.64Z	VF11.74D
180	(A) VF11.65E (B) VF11.65F	VF11.75L
225	(A) VF11.66M (B) VF11.66N	VF11.76S
270	(A) VF11.67T (B) VF11.67U	VF11.77Y
Su misura Custom-made min 30 max 360	(A) VF11.68Z (B) VF11.68A	VF11.78E

RICARICA WIRELESS INTEGRATA NEL TOP
INTEGRATED WIRELESS CHARGING IN THE TOP

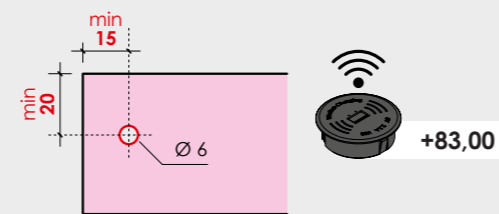

È possibile dotare la composizione di Ricarica wireless + presa USB per la quale è necessaria l'esecuzione di 1 foro su top (foratura a nostra cura solo se indicata da un disegno esplicativo. Foro su schiena e cappello a cura del cliente). **Applicabile in corrispondenza di elementi a giorno o con ante.**

It is possible to equip the composition of Wireless recharging + USB socket for which it is necessary to perform 1 hole on top (drilling only if indicated by an explanatory drawing. The hole in back and top of base unit to be made by customer). **Applicable to open elements or with doors.**

Alimentatore per ripiano con led
Power pack for shelf with led lighting

(cavo L 200 cm - 20 watt) in grado di supportare: da 1 a 6 ripiani L 45 e 60, da 1 a 4 ripiani L 90
(cable W 200 cm - 20 watt) capable of lighting from: 1 to 6 shelves W 45 and 60, 1 to 4 shelves W 90

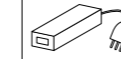

COD. VF32.56S

Interruttore wireless per ripiano con led
Wireless switch for shelf with led lighting

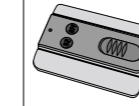

COD. VF32.57Y

COME DETERMINARE I PIEDI NECESSARI:
HOW TO CALCULATE NUMBER OF FEET NEEDED:



Si applicano esclusivamente sul fondo.
Esempio: Tante confezioni di 4 piedini ALFA 16, ALFA 25 e ETA da fissare sotto ogni elemento.

Be applied underneath to the bottom panel only. Example: One pack of 4 ALFA 16, ALFA 25 and ETA feet for fixing underneath each element.

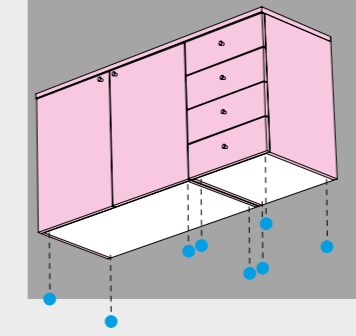

Si applicano esclusivamente sotto la Base. Esempio: Una confezione di 4 piedini SIGMA da fissare alle estremità più 1 piedino GAMMA centrale da sistemare in corrispondenza del punto di unione fra le unità.

Be applied underneath to the base only. Example: One pack of 4 SIGMA feet for fixing at the ends plus one "GAMMA central" feet for placing at each joint between units are always required.

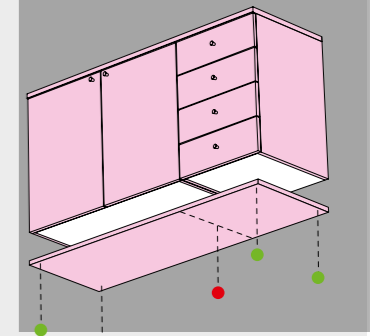

Piedini regolabili - Confezione 4 pezzi
Adjustable feet - Pack of 4

ALFA 16
H Ht 1,6



COD. VF33.86N

ALFA 25
H Ht 2,5

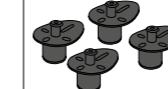

COD. VF32.32E

ETA
L W 10
H Ht 4

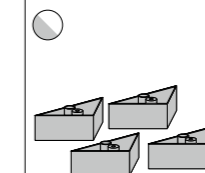

COD. VF32.33M

Piedini regolabili - Confezione 4 pezzi
Adjustable feet - Pack of 4

SIGMA
L W 8,3
H Ht 11

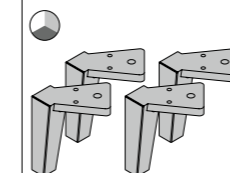

COD. VF32.34T

GAMMA
L W 3,6
H Ht 11

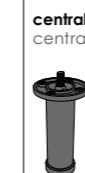

COD. VF32.35Z

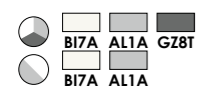

Pensili - P 32,5

Hanging units - Dpt 32.5

L'utilizzo del top non è obbligatorio.

- Sono completi di affacciglie per fissaggio al muro di tipo invisibile e dotate di antiinganciamiento.
- Sono compresi ripiani interni ogni 32 cm.

Using the top is not mandatory.

- They are complete with hangers for fixing to an invisible type wall and equipped with fischer screws.
- Included inner shelves every 32 cm.

	H Ht 32				H Ht 96		H Ht 128		H Ht 160		
L W 30											
COD.					VF12.54X	VF12.55D	VF12.64C	VF12.65K	VF12.74H	VF12.75Q	VF12.76W
VOLO	A										
	B										
WINDOW	A										
	B										
L W 45											
COD.	VF12.50W	VF12.51C	VF12.52K	VF12.53R	VF12.56L	VF12.57S	VF12.58Y	VF12.59E	VF12.77C	VF12.78K	VF12.79R
VOLO	A										
	B										
WINDOW	A										
	B										
L W 60											
COD.	VF12.60B	VF12.61H	VF12.62Q	VF12.63W	VF12.66R	VF12.67X	VF12.68D	VF12.69L			
VOLO	A										
	B										
WINDOW	A										
	B										
L W 90											
COD.	VF12.70G	VF12.71P	VF12.72V	VF12.73B							
VOLO	A										
	B										
WINDOW	A										
	B										



Frontali disponibili con apertura PUSH-PULL (no WINDOW)
Fronts available with PUSH-PULL opening (not WINDOW)

pag. 40
pag. 206

Posizionamento pomelli e maniglie
Knobs and handles position
Accessori per pensili
Hanging units accessories

Accessori per pensili

Hanging units accessories

	Ripiani interni Inner shelves	Ripiani interni in vetro trasparente Transparent glass inner shelves Solo ripiani a vista e ripiani all'interno delle ante Only shelves in open units and shelves within doors	Ripiani interni con led Inner shelves with led Da completare con alimentatore COD. VF32.56S To be completed with power pack COD. VF32.56S
	Sp Th 2,5 P Dpt 28,6 L W 26,3 41,3 56,3 86,3	Sp Th 0,8 P Dpt 28 L W 26,3 41,3 56,3 86,3	Sp Th 2,5 P Dpt 27,6 L W - 41,3 56,3 86,3
			
L W	COD.	COD.	COD.
30	VF31.22V	VF31.23B	-
45	VF34.65Z	VF34.68U	VF34.71D
60	VF34.66F	VF34.69A	VF34.72L
90	VF34.67N	VF34.70X	VF34.73S

Top Sp 2,5 - P 33,3
Top Th 2,5 - Dpt 33,3



L W		COD.
30	(A)	VF12.80N
	(B)	
45	(A)	VF12.81U
	(B)	
60	(A)	VF12.82A
	(B)	
90	(A)	VF12.83G
	(B)	
120	(A)	VF12.84P
	(B)	
135	(A)	VF12.85V
	(B)	
180	(A)	VF12.86B
	(B)	
225	(A)	VF12.87H
	(B)	
270	(A)	VF12.88Q
	(B)	
Su misura Custom-made min 30 max 360	(A)	VF12.89W
	(B)	

**Alimentatore per
ripiano con led**
Power pack for shelf
with led lighting

(cavo L 200 cm - 20 watt) in grado di
supportare: da 1 a 6 ripiani L 45 e 60,
da 1 a 4 ripiani L 90
(cable W 200 cm - 20 watt) capable
of lighting from: 1 to 6 shelves W 45
and 60, 1 to 4 shelves W 90

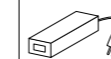

COD. VF32.56S

**Interruttore wireless per
ripiano con led**
Wireless switch for shelf
with led lighting

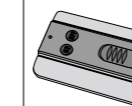

COD. VF32.57Y

Moduli sospesi SNAKE

SNAKE suspended modular units



- Sono completi di attaccaglie regolabili, per fissaggio al muro, di tipo invisibile e dotate di antifiscamento.
- Carico massimo consigliato (al netto dell'elemento): 20 Kg.
N.B. Il carico si intende uniformemente distribuito sull'elemento.

- Including adjustable, concealed hangers for wall-mounting with anti-release mechanism.
- Maximum recommended load (net of element): 20 Kg.
N.B. The load is intended as evenly distributed on the element.

P Dpt 26

L W 90
H Ht 14,8



COD. VF17.10W

A
B

P Dpt 26

Sx L

L W 90
H Ht 32

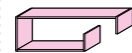

COD. VF17.11C

A
B

L W 119,5
H Ht 61,5

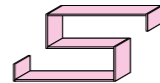

COD. VF17.12K

L W 147,5
H Ht 32

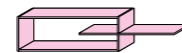

COD. VF17.13R

L W 177,5
H Ht 44,3

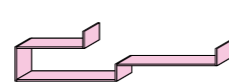

COD. VF17.14X

L W 177,5
H Ht 32

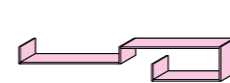

COD. VF17.15D

Dx R

L W 90
H Ht 32

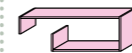

COD. VF17.16L

L W 119,5
H Ht 61,5

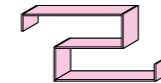

COD. VF17.17S

L W 147,5
H Ht 32

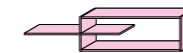

COD. VF17.18Y

L W 177,5
H Ht 32

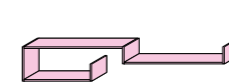

COD. VF17.19E

L W 177,5
H Ht 44,3

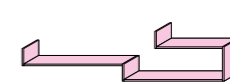

COD. VF17.20B

L W 119,5

H Ht 61,6

* Specificare cerniera Sx o Dx (disegno Sx)
Specify hinge L or R (L drawing)

P Dpt 32,5

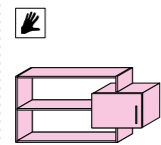

COD. VF17.21H *

P Dpt 32,5

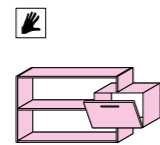

COD. VF17.22Q

P Dpt 32,5

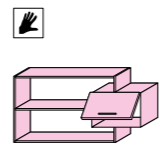

COD. VF17.23W

P Dpt 32,5

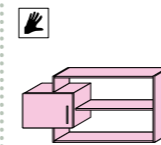

COD. VF17.24C *

P Dpt 32,5

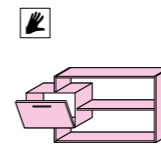

COD. VF17.25K

P Dpt 32,5

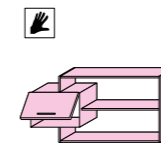

COD. VF17.26R

VOLO

A
B

WINDOW

A
B

Frontali disponibili con apertura PUSH-PULL (no WINDOW)
Fronts available with PUSH-PULL opening (not WINDOW)

pag. 40





Posizionamento pomelli e maniglie
Knobs and handles position

Moduli sospesi SNAKE

SNAKE suspended modular units

• Sono completi di attaccaglie regolabili, per fissaggio al muro, di tipo invisibile e dotate di antisfianciamento.
 • Carico massimo consigliato (al netto dell'elemento): 20 Kg.
 N.B. Il carico si intende uniformemente distribuito sull'elemento.

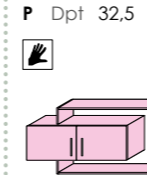
• Including adjustable, concealed hangers for wall-mounting with anti-release mechanism.
 • Maximum recommended load (net of element): 20 Kg.
 N.B. The load is intended as evenly distributed on the element.

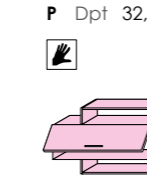
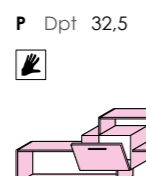
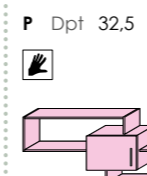
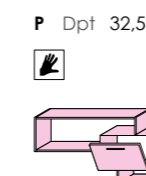
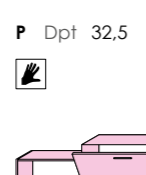
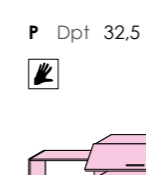
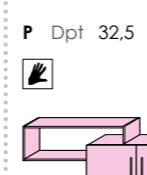
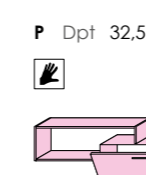
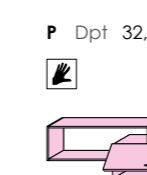
	Sx L			Dx R					
	<div style="display: flex; justify-content: space-around;"> <div style="border: 1px solid black; padding: 2px;">L W 119,5</div> <div style="border: 1px solid black; padding: 2px;">H Ht 61,6</div> </div>								
									
COD.	VF17.27X	VF17.28D	VF17.29L	VF17.30G	VF17.31P	VF17.32V			
VOLO	<input type="radio"/> A	<input type="radio"/> B	<input type="radio"/> B	<input type="radio"/> B	<input type="radio"/> B	<input type="radio"/> B			
WINDOW	<input type="radio"/> A	<input type="radio"/> B	<input type="radio"/> B	<input type="radio"/> B	<input type="radio"/> B	<input type="radio"/> B			
	<div style="display: flex; justify-content: space-around;"> <div style="border: 1px solid black; padding: 2px;">L W 160,9</div> <div style="border: 1px solid black; padding: 2px;">H Ht 61,6</div> </div> <p><small>* Specificare cerniera Sx o Dx (disegno Sx) Specify hinge L or R (L drawing)</small></p>								
									
COD.	VF17.33B *	VF17.34H	VF17.35Q	VF17.36W *	VF17.37C	VF17.38K			
VOLO	<input type="radio"/> A	<input type="radio"/> B	<input type="radio"/> B	<input type="radio"/> B	<input type="radio"/> B	<input type="radio"/> B			
WINDOW	<input type="radio"/> A	<input type="radio"/> B	<input type="radio"/> B	<input type="radio"/> B	<input type="radio"/> B	<input type="radio"/> B			
	<div style="display: flex; justify-content: space-around;"> <div style="border: 1px solid black; padding: 2px;">L W 205,9</div> <div style="border: 1px solid black; padding: 2px;">H Ht 61,6</div> </div>								
									
COD.	VF17.39R	VF17.40N	VF17.41U	VF17.42A	VF17.43G	VF17.44P			
VOLO	<input type="radio"/> A	<input type="radio"/> B	<input type="radio"/> B	<input type="radio"/> B	<input type="radio"/> B	<input type="radio"/> B			
WINDOW	<input type="radio"/> A	<input type="radio"/> B	<input type="radio"/> B	<input type="radio"/> B	<input type="radio"/> B	<input type="radio"/> B			

 Frontali disponibili con apertura PUSH-PULL (no WINDOW)
 Fronts available with PUSH-PULL opening (not WINDOW)

Facciate Fronts
VOLO

Finiture GRUPPO 1
GROUP 1 finishes

Finiture GRUPPO 2
GROUP 2 finishes

Rovere white*

(A) ☆	(A) ☆	(A) ☆	(A)	(B) ☆	(B) ☆
Rovere white RW3Q	Rovere gesso RG9L	Ciliegio bianco CB6K	Grigio Dorian GL4R	Cemento antico CA7A	Rovere cognac RC3Q
(B) ☆	(B)	(B)	(B)		
Royal oak RS4B	Grigio titanio GZ8T	Oliva LV5T	Cadaques CQ3Q		
(A)	(B)	(B)	(B)	(B)	
Bianco opaco B17A	Giallo zafferano GZ8A	Albicocca AB3C	Orchidea OR7L	Blu Egeo EG4L	

RESIDENCE E HOTEL
RESIDENCE AND HOTEL

Elementi per hotel e contract Contract and hotel elements	pag. 214
Testate continue su misura e letti accostabili Custom-made continuous headboards and his beds	pag. 216
Scheda prodotto Product information	pag. 218
Condizioni generali di vendita General sales conditions	pag. 220

Vetri Glass

Ante Doors
WINDOW

Colori telaio
Frame colours

Trasparente TR9M	Trasparente fumé FT8P	Stop sol ST6P	Specchio SP7L	Alluminio AL1A	Titan grey TG7H

Rovere white* Finitura unica per tutti i componenti in pannello presenti a listino non evidenziati con il colore Finiture GRUPPO 1 e/o Finiture GRUPPO 2.
Unique finish for all the panel components shown in the pricelist not highlighted with the color finishes GROUP 1 and/or finishes GROUP 2.

- (A) Finiture in fascia di prezzo A
Finishes in price range A
- (B) Finiture in fascia di prezzo B
Finishes in price range B
- (☆) Finiture con effetto materico
Finishes with textured effect

Elementi per hotel e contract

Contract and hotel elements

Armadi Wardrobes H Ht 225,6 Ht	L W 45 P Dpt 54,5 	L W 60 P Dpt 54,5 	L W 90 P Dpt 54,5 	Fianco finale End panel H Ht 225,6 P Dpt 54,5 Sp Th 1,8
	COD. VF12.98V A B	COD. VF12.99B A B	COD. VF13.00Y A B	COD. VF00.99Q A B

Armadi Wardrobes H Ht 257,6 Ht	L W 45 P Dpt 54,5 	L W 60 P Dpt 54,5 	L W 90 P Dpt 54,5 	Fianco finale End panel H Ht 257,6 P Dpt 54,5 Sp Th 1,8
	COD. VF13.02M A B	COD. VF13.03T A B	COD. VF13.01E A B	COD. VF01.99U A B

Portavaligie e pannelli a muro Luggage stands and wall panels	H Ht 61 P Dpt 52,8 L W 90 	H Ht 185 P Dpt 2,6 L W 90 	H Ht 185 P Dpt 6,6 L W 90 	H Ht 185 P Dpt 5,6 L W 90
	COD. VF13.29T A B	COD. VF13.30Q A B	COD. VF13.31W A B	COD. VF13.32C A B

Accessori Accessories	5 profili antisdrucchiolo per portavaligie 5 anti-sliding profiles for luggage stand P Dpt 45 Con biadesivo With biadhesive tape 	Specchio per pannelli a muro Mirror for wall panels H Ht 125 L W 60 	Appendiabiti Clothes hook BOLLINO P Dpt 4 Ø 10 	PLUS H Ht 6,5 P Dpt 3 L W 4,3
	COD. VF34.74Y A B	COD. VF34.75E A B	COD. VF32.61Q A B	COD. VF32.62W A B



Scrivanie portarfrigo Fridge holder desks Si consiglia di mantenerle staccate dalla parete posteriore per facilitare il raffreddamento del frigorifero. It is advisable to keep them detached from the rear wall to facilitate cooling of the refrigerator.	H Ht 77,6 P Dpt 57,1 L W 120 	H Ht 77,6 P Dpt 57,1 L W 135 	Su misura Customized min 91 - max 220 H Ht 77,6 P Dpt 57,1
	COD. senza frigo without fridge A B	COD. VF13.05F A B	COD. VF13.06N A B
COD. con frigo with fridge A B	COD. VF13.10D A B	COD. VF13.11L A B	COD. VF13.12S A B
VOLO	COD. VF13.08A A B	COD. VF15.26G A B	COD. VF15.27P A B

Scrivanie portarfrigo + portavaligie Fridge holder desks + luggage stands Si consiglia di mantenerle staccate dalla parete posteriore per facilitare il raffreddamento del frigorifero. It is advisable to keep them detached from the rear wall to facilitate cooling of the refrigerator.	H Ht 100 P Dpt 58,9 L W 210 	H Ht 100 P Dpt 58,9 L W 225
	COD. senza frigo without fridge A B	COD. VF13.15M A B
COD. con frigo with fridge A B	COD. VF13.17Z A B	COD. VF13.18F A B
VOLO	COD. VF13.20K A B	COD. VF13.21R A B
VOLO	COD. VF13.22X A B	COD. VF13.23D A B



Frigobar da incasso Built-in refrigerator Colore esterno: nero. Capacità: 40 Litri. Peso: 13,5 Kg. Tensione di alimentazione: 220 V. Outside colour: black. Capacity: 40 Litres. Weight: 13.5 Kg. Power supply voltage: 220V.	H Ht 54 P Dpt 45 L W 39 	H Ht 45 P Dpt 24 L W 31,5
	COD. VF34.76M A B	COD. VF34.76M A B

Testate continue su misura e letti accostabili

Custom-made continuous headboards and his beds

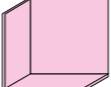
	Senza mensole Without shelves H Ht 90 L W min 45 - max 360 Sp Th 1,8 	Con 1 mensole With 1 shelf H Ht 90 P Dpt 27,8 (26 + 1,8) L W min 45 - max 360 Specificare Sx o Dx (disegno Sx) Specify L or R (drawings L)	Con 2 mensole With 2 shelves H Ht 90 P Dpt 27,8 (26 + 1,8) L W min 90 - max 360	Mensola Shelf P Dpt 26 L W 45 Sp Th 2,5 
COD.	VF13.99F	VF14.00C	VF14.01K	VF14.02R
	(A)			
	(B)			

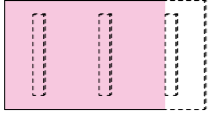
	Con 1 mensola WEB With 1 WEB shelf H Ht 90 P Dpt 21,6 (19,8 + 1,8) L W min 45 - max 360 Specificare Sx o Dx (disegno Sx) Specify L or R (drawings L)	Con 2 mensole WEB With 2 WEB shelves H Ht 90 P Dpt 21,6 (19,8 + 1,8) L W min 90 - max 360	Mensola WEB WEB shelf H Ht 42 P Dpt 19,8 L W 42 
COD.	VF14.03X	VF14.04D	VF16.43C
	(A)		
	(B)		

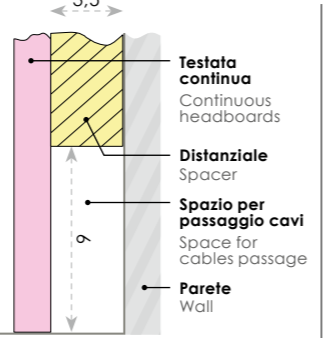
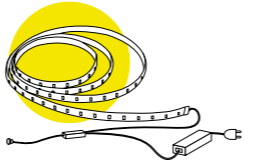
Senza mensole, con distanziali Without shelves, with spacers I distanziali permettono il passaggio di eventuali cavi elettrici. The spacers allow the passage of any electrical cables. H Ht 90 L W min 90 - max 200 Sp Th 5,3 	Con distanziali With spacers H Ht 90 L W min 210 - max 310 Sp Th 5,3 	 <p>Testata continua Continuous headboards</p> <p>Distanziale Spacer</p> <p>Spazio per passaggio cavi Space for cables passage</p> <p>Parete Wall</p>	Kit illuminazione led per testate letti. Led lighting kit for bed headboards. Fascia led L 120, 1 interruttore, cablaggi Led strip W 120, 1 switch, wiring 
COD.	VF14.05L	VF14.06S	VF34.00K
	(A)		
	(B)		

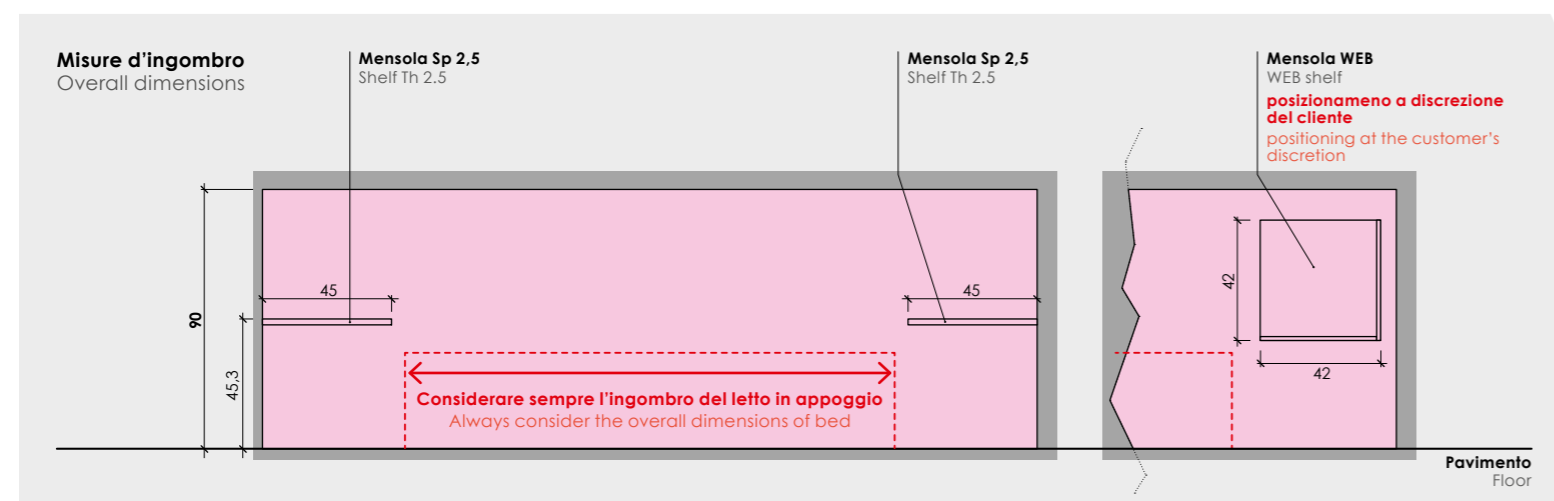

Microfibra ECOCHIC
ECOCHIC microfibre

Z66H Z67M Z68Q Z69T Z70R Z71U

*** RETE A CURA DEL CLIENTE.** In fase di ordinazione è indispensabile indicare L della rete.
BASE TO BE SUPPLIED BY THE CUSTOMER. When ordering, you must state the width of base.
Prodotto realizzato con componenti ignifughi in classe 1.
Product made with class 1 fire retardant components.
Consegna 4 settimane circa dal ricevimento dell'ordine.
Delivery approximately 4 weeks from order receipt.

Letti accostabili

Beds for continuous headboards

SPARTA

Refe a filo sponda
Bed base aligned with side

H Ht 46,1
P Dpt 197
L W 87,8
 97,8
 127,8
 167,8

NETTUNO

H Ht 33,6
P Dpt 199,5
L W 90
 100
 129
 170

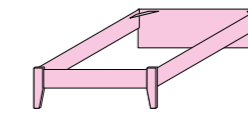
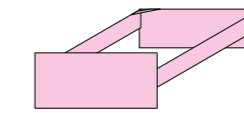

rete L bed base W	COD.	interno letto internal dimensions	COD.	interno letto internal dimensions
80 x 190	VF14.10H	81,5 x 191	VF14.20P	81,5 x 191
90 x 190	VF14.11Q	91,5 x 191	VF14.21V	91,5 x 191
120 x 190	VF14.12W	121,5 x 191	VF14.22B	121,5 x 191
160 x 190	VF14.13C	161,5 x 191	VF14.23H	161,5 x 192,5
Su misura Customized	50÷250 *			
	VF14.14K			

KANT

Completi di rete a doghe e sfoderabili
With lifting base and removables

Materiale imbottitura: Poliuretano flessibile densità 35 kg/m³. Vellutina anti fiamma.
Padding material: Flexible polyurethane, density 35 kg/m³. Flame resistant material.

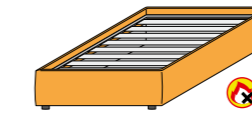

H Ht 37
P Dpt 201
L W -
 98
 128
 168

Fodere di rivestimento in microfibra Lavabili
Microfibre covers Washable

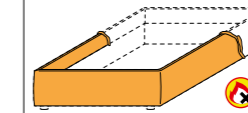

rete L bed base W	COD.	interno letto internal dimensions	COD.	rete L bed base W
90 x 190	VF14.30U	92 x 195	VF34.77T	90
120 x 190	VF14.31A	122 x 195	VF34.78Z	120
160 x 190	VF14.32G	162 x 195	VF34.79F	160